

Fisheye IP Camera

User's Manual

Ver. 1.4

Table of Contents

1. Overview	2
1.1 Features	2
1.2 Package Contents	3
1.3 Dimensions.....	4
1.4 Connectors	5
1.5 Cable Definition (Optional).....	6
2. Camera Cabling	7
2.1 Connect Power	7
2.2 Connect Ethernet Cable.....	7
3. System Requirements	8
4. Access Camera	9
5. Setup Video Resolution	14
6. Configuration Files Export / Import	15
Appendix A: Technical Specifications	16
Appendix B: Delete the Existing DC Viewer	18
Appendix C: Setup Internet Security	19
Appendix D: Video Resolution	20
Quad Streams.....	20
Triple Streams.....	25
Dual Streams	28
Single Stream	29

1. Overview

The Fisheye IP Camera is a high resolution surveillance solution featuring 360 Degree Panorama View that allows users to monitor a wide angle surveillance environment without blind spot with just one Camera. The Camera not only delivers clear images through multi-streaming video, its lens with up to 5 Mega-pixel high resolution image also provides panorama function with quad view that enables four different assigned angles images to display simultaneously for monitoring.

Furthermore, it has built-in IR LED and true day/night IR cut filter for supreme night time images. With compact outlook and rugged housing, the easy installing and weatherproof ability offers users to apply the Camera in various kinds of IP surveillance environment flexibly such as hotel, hospital, retailer store, parking lot, and factory, etc.







1.1 Features

- Progressive Scan CMOS Sensor
- 5M resolution
- Dual Streams, Full HD 1080P real-time + D1 real-time
- Quad Streams support
- Quad Streams Compression:
H.264 Baseline / Main / High Profile + MJPEG
- 360° Panorama View
- ePTZ
- Quad View
- Tampering Alarm
- Wide Dynamic Range
- Motion Detection
- Privacy Masks
- Day / Night (ICR)
- IR LED Module
- Built-in MIC & Speaker
- Weatherproof (IP66 International)*
- Micro SD support
- ONVIF support

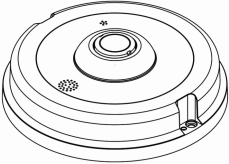
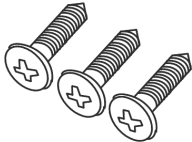
(*) Optional

1.2 Package Contents

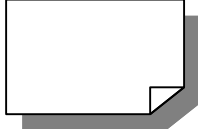
Please check the package contains the following items listed below.

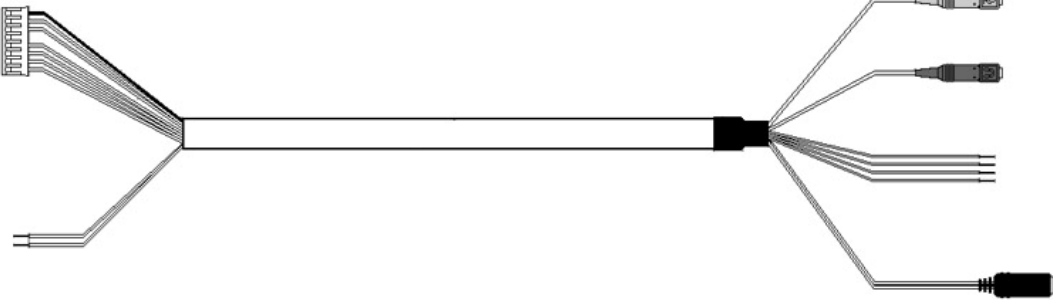
 <p>Fisheye IP Camera</p>	 <p>Self-tapping screws (x3)</p>	 <p>Plastic Anchors (x3)</p>	 <p>Security Screw (x1)</p>
 <p>Security Torx</p>	 <p>Power Terminal Block (x1)</p>	 <p>Quick Guide</p>	 <p>CD</p>
 <p>All In One Cable (Optional)</p>			



NOTE: The type of the supplied self-tapping screws is mainly for softer substrate / material installation such as wood. For other installation environment such as cement wall, it is required to pre-drill and use plastic anchors before fastening the supplied self-tapping screw on the wall.

1.3 Dimensions

The IP Camera's dimensions are shown below.

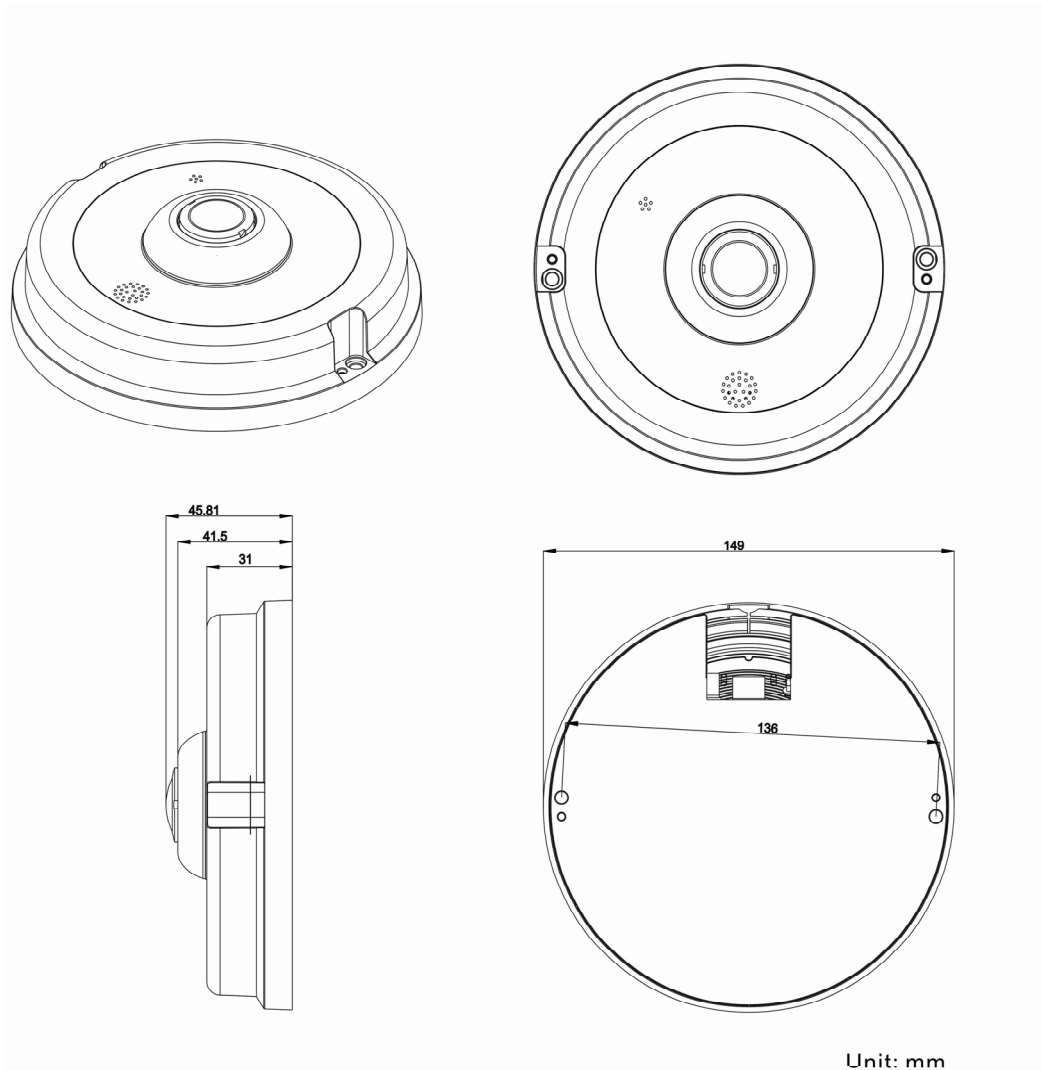

1.4 Connectors

Please remove the security screws and the cover to reach the connectors.



The diagram below shows the IP Camera's connectors and reset button. Definition for each will be given as follows.

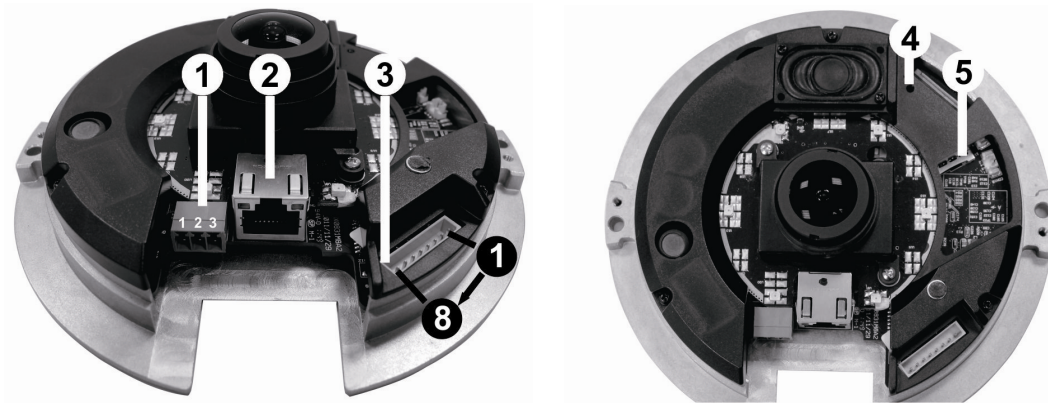

No.	Connector	Pin	Definition	Remarks	
1	Power*	DC 12V	1	Power	Power connection
			2	Reserved	
			3	GND	
		AC 24V	1	Power-1	
			2	Earth GND	
			3	Power-2	
2	RJ-45	-	10/100 Mbps Ethernet / PoE		
3	Alarm & Audio I/O*	-	Please refer to the Alarm & Audio I/O in the table under Cable Definition		
4	Reset Button	-	Restore to default setting Press the button with a proper tool		
5	Micro SD Card Slot	-	For video recording storage		

*All in One Cable is required for Power, Alarm and Audio I/O utilization.

1.5 Cable Definition (Optional)

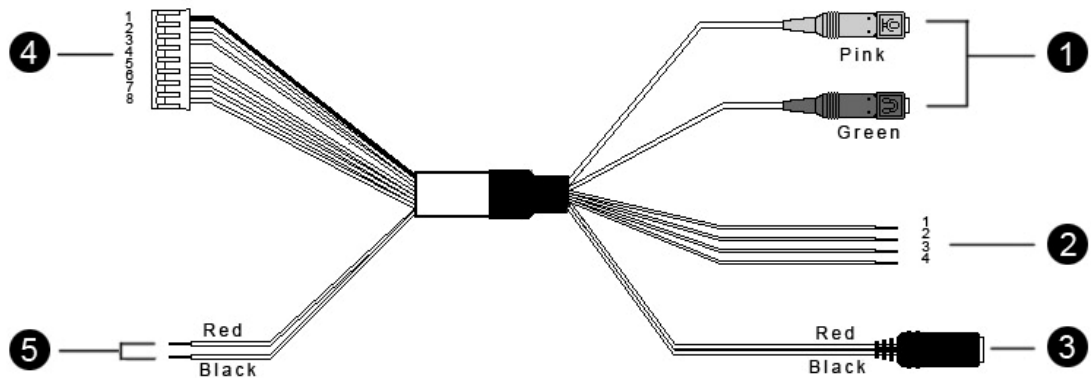

*Connect to the camera module

*Connect to devices and the power source

No.	Connector	Pin	Definition	Remarks
1	Audio I/O	Pink	Line In	Two-way audio transmission
		Green	Line Out	
2	Alarm (4-Pin Terminal Block)	1	ALM_IN -	Alarm connection
		2	ALM_IN +	
		3	ALM_OUT -	
		4	ALM_OUT +	
3	Power DC Jack	-	DC 12V	Power connection
	Power Wires	Red	AC 24V (+)	Remove DC Jack connector head, and apply AC 24V with Red and Black wires (as shown in the diagrams below).
Black		AC 24V (-)		
4	Alarm & Audio I/O	1	GND	Two-way audio transmission / Alarm connection
		2	Line In	
		3	Line Out	
		4	-	
		5	ALM_IN -	
		6	ALM_IN +	
		7	ALM_OUT -	
		8	ALM_OUT +	
5	Power Wires	Red	DC 12V (+) / AC 24V (+)	Power connection
		Black	DC 12V (-) / AC 24V (-)	

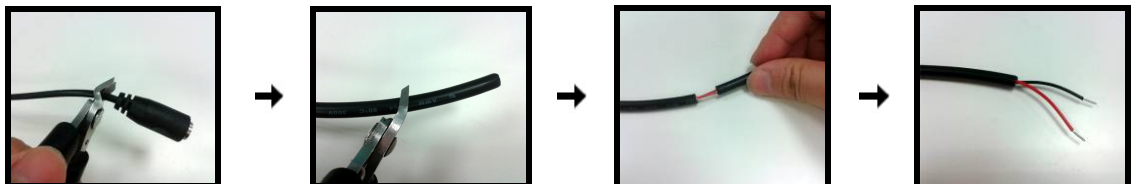

2. Camera Cabling

Please follow the instructions below to complete IP Camera connection.

2.1 Connect Power

Please refer to [Section: Connectors](#). Alternatively, connect the Ethernet cable to the camera's RJ-45 port and plug the other end of the cable into a PoE switch.



NOTE: If PoE is used, make sure Power Sourcing Equipment (PSE) is in use in the network.

2.2 Connect Ethernet Cable

Use of Category 5 Ethernet cable is recommended for network connection; to have best transmission quality, cable length shall not exceed 100 meters. Connect one end of the Ethernet cable to the RJ-45 connector of the IP Camera, and the other end of the cable to the network switch or PC.



NOTE: In some cases, Ethernet crossover cable might be needed when connecting the IP Camera directly to the PC.

Check the status of the link indicator and activity indicator LEDs. If the LEDs are unlit, please check LAN connection.

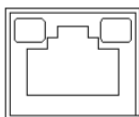

Green Link Light indicates good network connection.

Orange Activity Light flashes for network activity indication.

3. System Requirements

To perform the IP Camera via web browser, please ensure the PC is in good network connection, and meet system requirements as described below.

Items	System Requirement
Personal Computer	Minimum : 1. Intel® Core™ i5-2430M @ 2.4 GHz 2. 4 GB RAM
	Recommended: 1. Intel® Core™ i7-870 @ 2.93 GHz 2. 8 GB RAM
Operating System	Windows VISTA / Windows XP / Windows 7
Web Browser	Microsoft Internet Explorer 6.0 or later Firefox Chrome Safari
Network Card	10Base-T (10 Mbps) or 100Base-TX (100 Mbps) operation
Viewer	ActiveX control plug-in for Microsoft IE

4. Access Camera

For initial access to the IP Camera, users can search the camera through the installer program: DeviceSearch.exe, which can be found in “DeviceSearch” folder in the supplied CD.

Device Search Software Setup

Step 1: Double click on the program Device Search.exe. After its window appears, click on the <Device Search> button on the top side.

Step 2: The security alert window will pop up. Click on <Unblock> to continue.

Device Search

Step 3: Click on <Device Search> again, and all the finding IP devices will be listed in the page. The IP Camera’s default IP address is: **192.168.0.250**.

Step 4: Double click or right click and select <Browse> to access the camera directly via web browser.

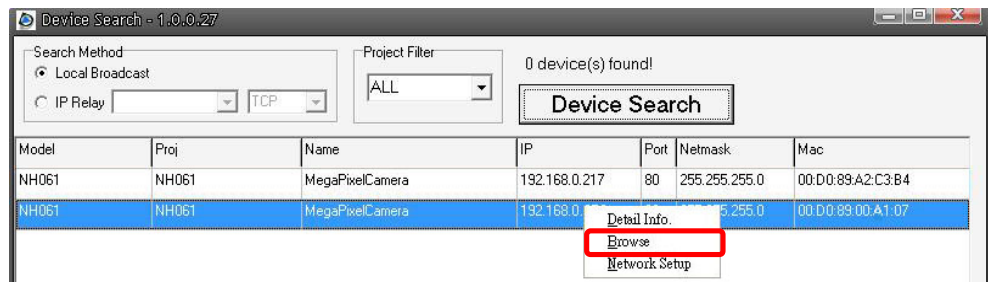

Step 5: Then the prompt window of request for entering default username and password will appear for logging in to the IP Camera.

The default login ID and password for the Administrator are:

Login ID	Password
Admin	1234



NOTE: ID and password are case sensitive.



NOTE: It is strongly advised that administrator’s password be altered for the security concerns. Refer to [Full HD Multiple Streams IP Camera Menu Tree](#) for further details.

Additionally, users can change the IP Camera's network property, either DHCP or Static IP, directly in the device finding list. Refer to the following section for changing the IP Camera's network property.

Example of Changing IP Camera's Network Property

Users can directly change an IP Camera's network property, ex. from static IP to DHCP, in the finding device list. The way to change the IP Camera's network property is specified below:

Step 1: In the finding device list, click on the network Speed Dome Camera that is wished to change its network property. On the selected item, right click and select <Network Setup>. Meanwhile, record the IP Camera's MAC address, for future identification.

Step 2: The <Network Setup> page will come out. Select <DHCP>, and click on <Apply> button down the page.

Step 3: Click on <OK> on the Note of setting change. Wait for one minute to re-search the IP Camera.

Step 4: Click on the <Device Search> button to re-search all the devices. Then select the IP Camera with the correct MAC address. Double click on the IP Camera, and the login window will come out.

Step 5: Enter User name and Password to access the IP Camera.

Installing DC Viewer Software Online

For the initial access to the IP Camera, a client program, DC Viewer, will be automatically installed to the PC when connecting to the IP Camera.

If the Web browser doesn't allow DC Viewer installation, please check the Internet security settings or ActiveX controls and plug-ins settings (refer to [Section: Setup Internet Security](#)) to continue the process.

The Information Bar (just below the URL bar) may come out and ask for permission to install the ActiveX Control for displaying video in browser. Right click on the Information Bar and select <Install ActiveX Control...> to allow the installation.

The download procedure of DC Viewer software is specified as follows.

Step 1: In the DC Viewer installation window, click on <Next> to start installation.

Step 2: The status bar will show the installation progress. After the installation is completed, click on <Finish> to exit the installation process.

Step 3: Click on <Finish> to close the DC Viewer installation page.

Once the DC Viewer is successfully installed, the IP Camera's Home page will be able to correctly display as the figure below.

Ceiling Mount Installed Camera

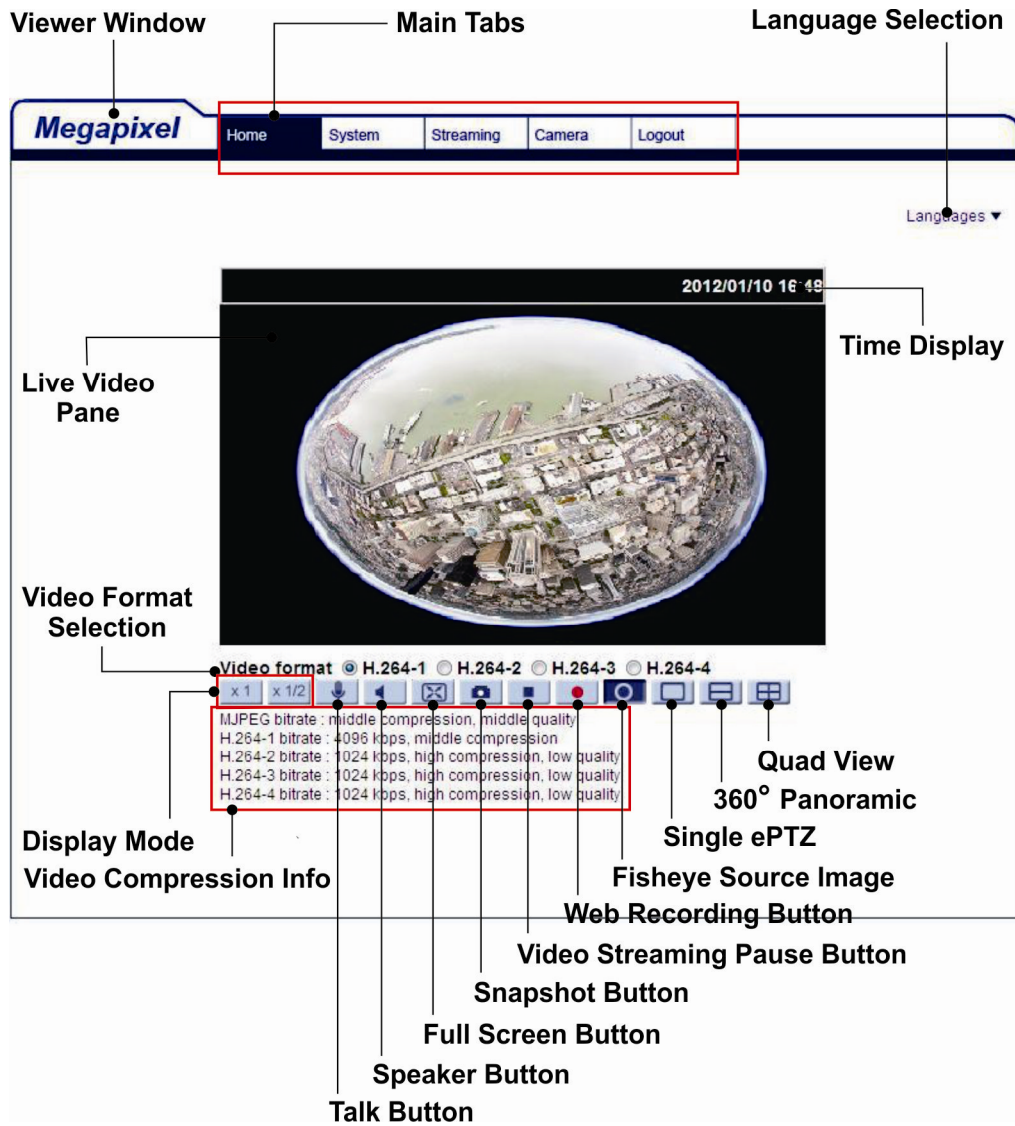

Wall Mount Installed Camera

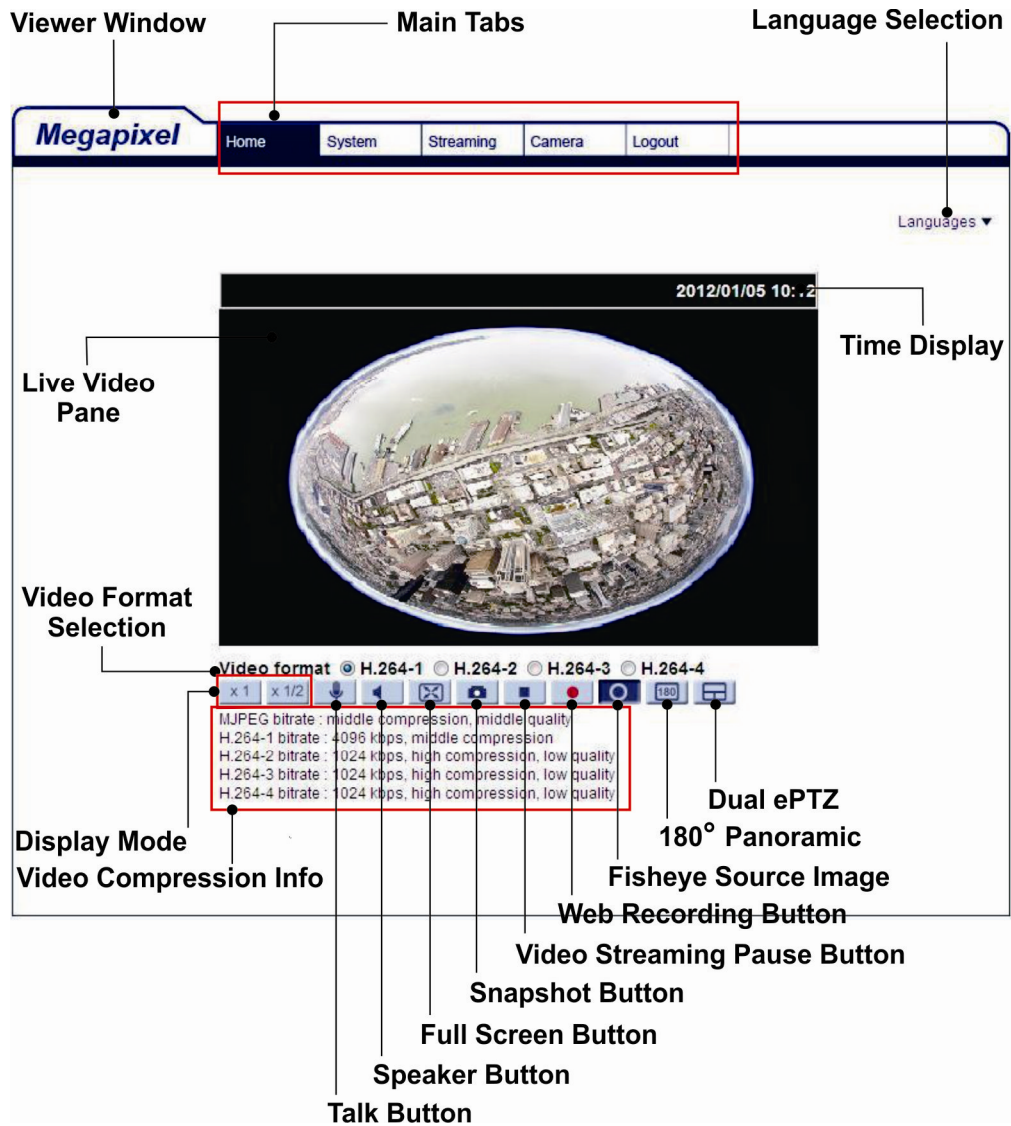

Note: Please refer to [Full HD Multiple Streams IP Camera Menu Tree](#) for more button function detail.

5. Setup Video Resolution

Users can setup Video Resolution on Video Format page of the user-friendly browser-based configuration interface.

Video Format can be found under this path: **Streaming> Video Format**.

The screenshot shows the Megapixel configuration interface. The top navigation bar includes 'Home', 'System', 'Streaming', 'Camera', and 'Logout'. The 'Streaming' menu is highlighted in red. On the left sidebar, the 'Video Format' menu item is highlighted in red. The main content area is titled 'Video Format' and contains the following sections:

- Video Resolution :** A dropdown menu is set to 'H.264 + H.264'. Below it, 'H.264-1 format' is set to '2592 x 1944 (12 fps)' and 'H.264-2 format' is set to '720 x 480 (12 fps)'. 'BNC support' is 'N/A'. A 'Save' button is at the bottom.
- Note :** Image attachment by FTP or E-mail will be available only while MJPEG streaming is selected.
- Text Overlay Settings :** Includes checkboxes for 'Include date', 'Include time', and 'Include text string' (with an input field). A 'Save' button is at the bottom.
- Video Rotate Type :** A dropdown menu is set to 'Normal video'. A 'Save' button is at the bottom.
- GOV Settings :** Includes input fields for 'H.264-1 GOV Length' (60), 'H.264-2 GOV Length' (60), 'H.264-3 GOV Length' (30), and 'H.264-4 GOV Length' (30). A 'Save' button is at the bottom.
- H.264 Profile :** Includes dropdown menus for 'H.264-1', 'H.264-2', 'H.264-3', and 'H.264-4', all set to 'Main profile'. A 'Save' button is at the bottom.

The default value of Video Resolution is: H.264 2592 x 1944 (12 fps) + H.264 720 x 480 (12 fps). For more Video Resolution combination detail, please refer to [Appendix: Video Resolution](#). Click on <Save> to confirm the setting.

6. Configuration Files Export / Import

To export / import configuration files, users can access the Maintenance page on the user-friendly browser-based configuration interface.

The Maintenance setting can be found under this path: **System> Maintenance**.

Users can export configuration files to a specified location and retrieve data by uploading an existing configuration file to the IP Camera.

Export

Users can save the system settings by exporting the configuration file (.bin) to a specified location for future use. Click on the <Export> button, and the popup File Download window will come out. Click on <Save> and specify a desired location for saving the configuration file.

Upload

To copy an existing configuration file to the IP Camera, please first click on <Browse> to select the configuration file, and then click on the <Upload> button for uploading.

Appendix A: Technical Specifications

Camera		W8
Image Sensor		5M Progressive CMOS
Effective Pixels		2592(H) x 1944(V)
Minimum illumination		0.2 lux (Color) @ F2.8 0.02 lux (B/W) @ F2.8
White Balance		Manual / AWB / ATW
Shutter Speed		1 ~ 1/10k sec.
Lens		
Lens	Stereo Projection Type	1/2.5" Fisheye Lens
Focal Length		1.05 mm
F Number		F2.8
FOV		180° @ Full Resolution
Operation		
Multiple Languages		English / French / German / Italian / Korean / Simplified Chinese / Traditional Chinese / Russian
Image Setting	Backlight Compensation	On / Off
	White Balance	Auto / Manual
	Noise Reduction (3D)	On / Off
	Wide Dynamic Range	On / Off
	Privacy Mask	On / Off
	Brightness	Manual
	Exposure	Auto / Manual
	Sharpness	Manual
	Contrast	Manual
	Saturation	Manual
	Hue	Manual
	Digital Zoom	Support
	Motion detection	On / Off
	Privacy Mask Type	Color
Audio	Type	Built-in Speaker (Max. 2W Mono) / Microphone or Two-way Audio (Line in / Line out)*
	Compression	G.711 / G.726
Network		
Interface		RJ-45, 10/100 Mbps Ethernet
Video Compression		H.264 Baseline / Main Profile / High Profile / MJPEG
Video Streaming	Single Stream: 2592 x 1944 (12 fps)	
	Single Stream: 2048 x 1536 (15 fps)	
	Simultaneous H.264 1080p (25/30 fps) + MJPEG D1 (25/30 fps)	
	Simultaneous H.264 1080p (25/30 fps) + H.264 D1 (25/30 fps)	
Quad Streams		
Video Resolution	H.264	5M (2592 x 1944) / 3M (2048 x 1536) / Full HD 1080P / SXGA / HD 720P / XGA / SVGA / D1 / VGA / CIF
	MJPEG	Full HD 1080P / SXGA / HD 720P / XGA / SVGA / D1 / VGA / CIF
Protocol		IPv4/v6, TCP/IP, UDP, RTP, RTSP, HTTP, HTTPS, ICMP, FTP, SMTP, DHCP, PPPoE, UPnP, IGMP, SNMP, QoS, ONVIF
Security		HTTPS / IP Filter / IEEE 802.1x
Alarm*	Input	1 Set 5V 10kΩ pull up
	Output	1 Set Photo Relay Output 300V DC / AC
Event Notification		HTTP / FTP / SMTP
Micro SD		microSDHC 32GB support
Supported Web Browser		Internet Explorer (6.0+) / Chrome / Firefox / Safari
User Account		20
Password Levels		User and Administrator

Mechanical		
Built-in IR Illuminator	Working Distance	5 m
	Wavelength	850 nm
	Number of LEDs	6
Lens Mounting		M12 Fisheye Lens
Connectors	Alarm & Audio	8 Pin Terminal Block, Pitch 2.5 mm
	Power	3 Pin Terminal Block
	Ethernet	RJ-45
All in one Cable*		
Audio I / O		Line in / Line Out
Alarm		4 Pin Wire Cables
Power	DC 12V	DC Jack
	AC 24V	Power Wire Cables AC 24V (+), AC 24V (-)
General		
Operating Temperature		-10°C ~ 50°C (14°F ~ 122°F)
Humidity		10% ~ 90%, No Condensation
Weatherproof Standard		Rugged Camera- IP66
Dimension		Ø 149 x 45.8 mm (Ø 5.87 x 1.80 in.)
Weight		350 g (0.77 lbs)
Power Source		DC 12V* / AC 24V* / PoE
Power Consumption		Max. 12W
Regulatory		CE / FCC / RoHS

(*) Optional

Appendix B: Delete the Existing DC Viewer

For users who have installed the DC Viewer in the PC previously, please first remove the existing DC Viewer from the PC before accessing to the IP Camera.

Deleting the DC Viewer

In the Windows <Start Menu>, activate <Control Panel>, and then double click on <Add or Remove Programs>. In the <Currently installed programs> list, select <DC Viewer> and click on the button <Remove> to uninstall the existing DC Viewer.

Deleting Temporary Internet Files

To improve browser performance, it is suggested to clean up the all the files in the Temporary Internet Files.

The procedure is as follows:

Step 1: Click on the <Tools> tab on the menu bar and select <Internet Options>.

Step 2: Click on the <Delete> button under <Browsing history> section. Then click on the <Delete Files> button under the <Temporary Internet files> section.

Step 3: A confirmation window will pop up. Click on <Yes> to start deleting the files.

Appendix C: Setup Internet Security

If ActiveX control installation is blocked, please either set Internet security level to default or change ActiveX controls and plug-ins settings.

Internet Security Level: Default

Step 1: Start the Internet Explorer (IE).

Step 2: Click on the <Tools> tab on the menu bar and select <Internet Options>.

Step 3: Click on the <Security> tab, and select <Internet> zone.

Step 4: Down the page, click on the <Default Level> button and click on <OK> to confirm the setting. Close the browser window, and restart a new one later to access the IP Camera.

ActiveX Controls and Plug-ins Settings

Step 1: Repeat **Steps 1~3** of the previous section above.

Step 2: Down the page, click on the <Custom Level> button to change ActiveX controls and plug-ins settings. The Security Settings window will pop up.

Step 3: Under <ActiveX controls and plug-ins>, set **ALL** items (as listed below) to <Enable> or <Prompt>. Please note that the items vary by IE version.

ActiveX controls and plug-ins settings:

1. Allow previously unused ActiveX controls to run without prompt.
2. Allow Scriptlets.
3. Automatic prompting for ActiveX controls.
4. Binary and script behaviors.
5. Display video and animation on a webpage that does not use external media player.
6. Download signed ActiveX controls.
7. Download unsigned ActiveX controls.
8. Initialize and script ActiveX controls not marked as safe for scripting.
9. Run ActiveX controls and plug-ins.
10. Script ActiveX controls marked safe for scripting.

Step 4: Click on <OK> to accept the settings and close the Security Settings window.

Step 5: Click on <OK> to close the Internet Options screen.

Step 6: Close the browser window, and restart a new one later to access the IP Camera.

Appendix D: Video Resolution

Quad Streams

H.264 + H.264 + H.264 + H.264 / MJPEG					
H.264-1	H.264-2	H.264-3	H.264-4 / MJPEG		
2592 x 1944 (12 fps)	720 x 480 (12 fps)	720 x 480 (12 fps)	352 x 240 (12 fps)		
		640 x 480 (12 fps)	640 x 480 (12 fps)		
		352 x 240 (12 fps)	352 x 240 (12 fps)		
	640 x 480 (12 fps)	640 x 480 (12 fps)	640 x 480 (12 fps)	640 x 480 (12 fps)	
			352 x 240 (12 fps)	352 x 240 (12 fps)	
			352 x 240 (12 fps)	352 x 240 (12 fps)	
2048 x 1536 (15 fps)	1280 x 720 (15 fps)	720 x 480 (15 fps)	640 x 480 (15 fps)		
			352 x 240 (15 fps)		
		640 x 480 (15 fps)	640 x 480 (15 fps)		
			352 x 240 (15 fps)		
		352 x 240 (15 fps)	352 x 240 (15 fps)		
		352 x 240 (15 fps)	352 x 240 (15 fps)		
	800 x 600 (15 fps)	800 x 600 (15 fps)	800 x 600 (15 fps)	720 x 480 (15 fps)	
				640 x 480 (15 fps)	
				352 x 240 (15 fps)	
		720 x 480 (15 fps)	720 x 480 (15 fps)	720 x 480 (15 fps)	720 x 480 (15 fps)
					640 x 480 (15 fps)
					352 x 240 (15 fps)
	640 x 480 (15 fps)	640 x 480 (15 fps)	640 x 480 (15 fps)	640 x 480 (15 fps)	
				352 x 240 (15 fps)	
				352 x 240 (15 fps)	
		352 x 240 (15 fps)	352 x 240 (15 fps)	352 x 240 (15 fps)	352 x 240 (15 fps)
					640 x 480 (15 fps)
					352 x 240 (15 fps)
	352 x 240 (15 fps)	352 x 240 (15 fps)	352 x 240 (15 fps)	352 x 240 (15 fps)	
				640 x 480 (15 fps)	
				352 x 240 (15 fps)	

H.264 + H.264 + H.264 + H.264 / MJPEG					
H.264-1	H.264-2	H.264-3	H.264-4 / MJPEG		
1920 x 1080 (15 fps)	1280 x 1024 (15 fps)	1280 x 720 (15 fps)	720 x 480 (15 fps)		
			640 x 480 (15 fps)		
			352 x 240 (15 fps)		
		1280 x 1024 (15 fps)	800 x 600 (15 fps)	720 x 480 (30 fps)	640 x 480 (30 fps)
					352 x 240 (30 fps)
			720 x 480 (15 fps)	720 x 480 (30 fps)	640 x 480 (30 fps)
					352 x 240 (30 fps)
	640 x 480 (30 fps)		640 x 480 (30 fps)	640 x 480 (30 fps)	
				352 x 240 (30 fps)	
	352 x 240 (30 fps)	352 x 240 (30 fps)	352 x 240 (30 fps)		
			352 x 240 (30 fps)		
	1280 x 720 (15 fps)	1280 x 720 (15 fps)	800 x 600 (30 fps)	720 x 480 (30 fps)	
				640 x 480 (30 fps)	
				352 x 240 (30 fps)	
		1280 x 720 (15 fps)	720 x 480 (30 fps)	720 x 480 (30 fps)	640 x 480 (30 fps)
					640 x 480 (30 fps)
			640 x 480 (30 fps)	640 x 480 (30 fps)	640 x 480 (30 fps)
					640 x 480 (30 fps)
	1280 x 720 (30 fps)	720 x 480 (30 fps)	352 x 240 (30 fps)	352 x 240 (30 fps)	
				352 x 240 (30 fps)	
				352 x 240 (30 fps)	
	1024 x 768 (15 fps)	800 x 600 (30 fps)	720 x 480 (30 fps)	720 x 480 (30 fps)	
				640 x 480 (30 fps)	
				640 x 480 (30 fps)	
		1024 x 768 (15 fps)	720 x 480 (30 fps)	640 x 480 (30 fps)	640 x 480 (30 fps)
					640 x 480 (30 fps)
					640 x 480 (30 fps)
	1024 x 768 (30 fps)	800 x 600 (30 fps)	352 x 240 (30 fps)	352 x 240 (30 fps)	
				352 x 240 (30 fps)	
				352 x 240 (30 fps)	
				352 x 240 (30 fps)	
	800 x 600 (30 fps)	800 x 600 (30 fps)	720 x 480 (30 fps)	720 x 480 (30 fps)	
640 x 480 (30 fps)					
352 x 240 (30 fps)					
800 x 600 (30 fps)		720 x 480 (30 fps)	640 x 480 (30 fps)	640 x 480 (30 fps)	
				352 x 240 (30 fps)	
		640 x 480 (30 fps)	640 x 480 (30 fps)	640 x 480 (30 fps)	
				352 x 240 (30 fps)	
720 x 480 (30 fps)	720 x 480 (30 fps)	352 x 240 (30 fps)	352 x 240 (30 fps)		
			352 x 240 (30 fps)		
			352 x 240 (30 fps)		
640 x 480 (30 fps)	640 x 480 (30 fps)	640 x 480 (30 fps)	640 x 480 (30 fps)		
			352 x 240 (30 fps)		
			352 x 240 (30 fps)		
1920 x 1080 (30 fps)	352 x 240 (30 fps)	352 x 240 (30 fps)	352 x 240 (30 fps)		

H.264 + H.264 + H.264 + H.264 / MJPEG				
H.264-1	H.264-2	H.264-3	H.264-4 / MJPEG	
1280 x 1024 (15 fps)	1280 x 1024 (15 fps)	1280 x 720 (15 fps)	720 x 480 (30 fps) 640 x 480 (30 fps)	
		1280 x 720 (30 fps)	352 x 240 (30 fps)	
		800 x 600 (30 fps)	720 x 480 (30 fps)	720 x 480 (30 fps)
			640 x 480 (30 fps)	640 x 480 (30 fps)
			352 x 240 (30 fps)	352 x 240 (30 fps)
		720 x 480 (30 fps)	720 x 480 (30 fps)	720 x 480 (30 fps)
	640 x 480 (30 fps)	640 x 480 (30 fps)	640 x 480 (30 fps)	
	1280 x 1024 (30 fps)	720 x 480 (30 fps)	352 x 240 (30 fps)	352 x 240 (30 fps)
		640 x 480 (30 fps)	352 x 240 (30 fps)	352 x 240 (30 fps)
		352 x 240 (30 fps)	352 x 240 (30 fps)	352 x 240 (30 fps)
	1280 x 720 (15 fps)	1280 x 720 (30 fps)	720 x 480 (30 fps)	720 x 480 (30 fps)
			640 x 480 (30 fps)	640 x 480 (30 fps)
			352 x 240 (30 fps)	352 x 240 (30 fps)
	1280 x 720 (30 fps)	800 x 600 (30 fps)	720 x 480 (30 fps)	720 x 480 (30 fps)
			640 x 480 (30 fps)	640 x 480 (30 fps)
			352 x 240 (30 fps)	352 x 240 (30 fps)
		720 x 480 (30 fps)	720 x 480 (30 fps)	720 x 480 (30 fps)
			640 x 480 (30 fps)	640 x 480 (30 fps)
			352 x 240 (30 fps)	352 x 240 (30 fps)
	640 x 480 (30 fps)	640 x 480 (30 fps)	640 x 480 (30 fps)	
		352 x 240 (30 fps)	352 x 240 (30 fps)	
		352 x 240 (30 fps)	352 x 240 (30 fps)	
	1024 x 768 (30 fps)	800 x 600 (30 fps)	720 x 480 (30 fps)	720 x 480 (30 fps)
			640 x 480 (30 fps)	640 x 480 (30 fps)
352 x 240 (30 fps)			352 x 240 (30 fps)	
720 x 480 (30 fps)		720 x 480 (30 fps)	720 x 480 (30 fps)	
		640 x 480 (30 fps)	640 x 480 (30 fps)	
		352 x 240 (30 fps)	352 x 240 (30 fps)	
800 x 600 (30 fps)	800 x 600 (30 fps)	720 x 480 (30 fps)		
	720 x 480 (30 fps)	720 x 480 (30 fps)		
	640 x 480 (30 fps)	640 x 480 (30 fps)		
1280 x 1024 (30 fps)	1024 x 768 (30 fps)	352 x 240 (30 fps)	352 x 240 (30 fps)	
	800 x 600 (30 fps)	800 x 600 (30 fps)	352 x 240 (30 fps)	
		720 x 480 (30 fps)	352 x 240 (30 fps)	
		640 x 480 (30 fps)	640 x 480 (30 fps)	
	720 x 480 (30 fps)	720 x 480 (30 fps)	352 x 240 (30 fps)	352 x 240 (30 fps)
			640 x 480 (30 fps)	640 x 480 (30 fps)
			352 x 240 (30 fps)	352 x 240 (30 fps)
	640 x 480 (30 fps)	640 x 480 (30 fps)	640 x 480 (30 fps)	
		352 x 240 (30 fps)	352 x 240 (30 fps)	
		352 x 240 (30 fps)	352 x 240 (30 fps)	
	352 x 240 (30 fps)	352 x 240 (30 fps)	352 x 240 (30 fps)	
	1280 x 720 (15 fps)	1280 x 720 (15 fps)	1280 x 720 (30 fps)	720 x 480 (30 fps) 640 x 480 (30 fps)
1280 x 720 (30 fps)		1280 x 720 (30 fps)	352 x 240 (30 fps)	
		800 x 600 (30 fps)	720 x 480 (30 fps)	
		720 x 480 (30 fps)	720 x 480 (30 fps)	
		640 x 480 (30 fps)	640 x 480 (30 fps)	
1024 x 768 (30 fps)		800 x 600 (30 fps)	800 x 600 (30 fps)	720 x 480 (30 fps) 640 x 480 (30 fps)

H.264 + H.264 + H.264 + H.264 / MJPEG				
H.264-1	H.264-2	H.264-3	H.264-4 / MJPEG	
1280 x 720 (30 fps)	1280 x 720 (30 fps)	800 x 600 (30 fps)	352 x 240 (30 fps)	
		720 x 480 (30 fps)	352 x 240 (30 fps)	
		640 x 480 (30 fps)	352 x 240 (30 fps)	
		352 x 240 (30 fps)	352 x 240 (30 fps)	
	1024 x 768 (30 fps)	800 x 600 (30 fps)	800 x 600 (30 fps)	352 x 240 (30 fps)
			720 x 480 (30 fps)	720 x 480 (30 fps)
			640 x 480 (30 fps)	640 x 480 (30 fps)
			352 x 240 (30 fps)	352 x 240 (30 fps)
	800 x 600 (30 fps)	720 x 480 (30 fps)	800 x 600 (30 fps)	720 x 480 (30 fps)
			720 x 480 (30 fps)	640 x 480 (30 fps)
			640 x 480 (30 fps)	640 x 480 (30 fps)
			352 x 240 (30 fps)	352 x 240 (30 fps)
	720 x 480 (30 fps)	640 x 480 (30 fps)	800 x 600 (30 fps)	720 x 480 (30 fps)
			720 x 480 (30 fps)	640 x 480 (30 fps)
			640 x 480 (30 fps)	640 x 480 (30 fps)
			352 x 240 (30 fps)	352 x 240 (30 fps)
	640 x 480 (30 fps)	352 x 240 (30 fps)	800 x 600 (30 fps)	640 x 480 (30 fps)
			720 x 480 (30 fps)	352 x 240 (30 fps)
			640 x 480 (30 fps)	352 x 240 (30 fps)
			352 x 240 (30 fps)	352 x 240 (30 fps)
	1024 x 768 (30 fps)	1024 x 768 (30 fps)	800 x 600 (30 fps)	720 x 480 (30 fps)
			720 x 480 (30 fps)	640 x 480 (30 fps)
			640 x 480 (30 fps)	640 x 480 (30 fps)
			352 x 240 (30 fps)	352 x 240 (30 fps)
800 x 600 (30 fps)		720 x 480 (30 fps)	800 x 600 (30 fps)	720 x 480 (30 fps)
			720 x 480 (30 fps)	640 x 480 (30 fps)
			640 x 480 (30 fps)	640 x 480 (30 fps)
			352 x 240 (30 fps)	352 x 240 (30 fps)
720 x 480 (30 fps)		640 x 480 (30 fps)	800 x 600 (30 fps)	720 x 480 (30 fps)
			720 x 480 (30 fps)	640 x 480 (30 fps)
			640 x 480 (30 fps)	640 x 480 (30 fps)
			352 x 240 (30 fps)	352 x 240 (30 fps)
640 x 480 (30 fps)		352 x 240 (30 fps)	800 x 600 (30 fps)	640 x 480 (30 fps)
			720 x 480 (30 fps)	352 x 240 (30 fps)
			640 x 480 (30 fps)	352 x 240 (30 fps)
			352 x 240 (30 fps)	352 x 240 (30 fps)

H.264 + H.264 + H.264 + H.264 / MJPEG				
H.264-1	H.264-2	H.264-3	H.264-4 / MJPEG	
800 x 600 (30 fps)	800 x 600 (30 fps)	800 x 600 (30 fps)	352 x 240 (30 fps)	
		720 x 480 (30 fps)	720 x 480 (30 fps)	720 x 480 (30 fps)
			640 x 480 (30 fps)	640 x 480 (30 fps)
		720 x 480 (30 fps)	640 x 480 (30 fps)	640 x 480 (30 fps)
	640 x 480 (30 fps)		352 x 240 (30 fps)	352 x 240 (30 fps)
			720 x 480 (30 fps)	720 x 480 (30 fps)
	640 x 480 (30 fps)		640 x 480 (30 fps)	640 x 480 (30 fps)
	640 x 480 (30 fps)	640 x 480 (30 fps)	640 x 480 (30 fps)	640 x 480 (30 fps)
			352 x 240 (30 fps)	352 x 240 (30 fps)
		352 x 240 (30 fps)	352 x 240 (30 fps)	352 x 240 (30 fps)
			352 x 240 (30 fps)	352 x 240 (30 fps)
	720 x 480 (30 fps)	720 x 480 (30 fps)	720 x 480 (30 fps)	720 x 480 (30 fps)
640 x 480 (30 fps)				640 x 480 (30 fps)
640 x 480 (30 fps)			640 x 480 (30 fps)	640 x 480 (30 fps)
			352 x 240 (30 fps)	352 x 240 (30 fps)
640 x 480 (30 fps)		640 x 480 (30 fps)	640 x 480 (30 fps)	640 x 480 (30 fps)
			352 x 240 (30 fps)	352 x 240 (30 fps)
		352 x 240 (30 fps)	352 x 240 (30 fps)	352 x 240 (30 fps)
			352 x 240 (30 fps)	352 x 240 (30 fps)
640 x 480 (30 fps)	640 x 480 (30 fps)	640 x 480 (30 fps)	640 x 480 (30 fps)	
		352 x 240 (30 fps)	352 x 240 (30 fps)	
	352 x 240 (30 fps)	352 x 240 (30 fps)	352 x 240 (30 fps)	
352 x 240 (30 fps)	352 x 240 (30 fps)	352 x 240 (30 fps)	352 x 240 (30 fps)	

Triple Streams

H.264-1 + H.264-2 + H.264-3 / MJPEG			
H.264-1	H.264-2	H.264-3 / MJPEG	
2592 x 1944 (12 fps)	720 x 480 (12 fps)	720 x 480 (12 fps)	
		640 x 480 (12 fps)	
		352 x 240 (12 fps)	
	640 x 480 (12 fps)	640 x 480 (12 fps)	640 x 480 (12 fps)
			352 x 240 (12 fps)
			352 x 240 (12 fps)
2048 x 1536 (15 fps)	1280 x 720 (15 fps)	720 x 480 (15 fps)	
		640 x 480 (15 fps)	
		352 x 240 (15 fps)	
	800 x 600 (15 fps)	800 x 600 (15 fps)	800 x 600 (15 fps)
			720 x 480 (15 fps)
			640 x 480 (15 fps)
	720 x 480 (15 fps)	720 x 480 (15 fps)	640 x 480 (15 fps)
			352 x 240 (15 fps)
			352 x 240 (15 fps)
	640 x 480 (15 fps)	640 x 480 (15 fps)	640 x 480 (15 fps)
			352 x 240 (15 fps)
			352 x 240 (15 fps)
	352 x 240 (15 fps)	352 x 240 (15 fps)	352 x 240 (15 fps)
			352 x 240 (15 fps)
			352 x 240 (15 fps)
1920 x 1080 (15 fps)	1280 x 1024 (15 fps)	1280 x 720 (15 fps)	
		800 x 600 (30 fps)	
		720 x 480 (30 fps)	
		640 x 480 (30 fps)	
		352 x 240 (30 fps)	
	1280 x 720 (15 fps)	1280 x 720 (30 fps)	800 x 600 (30 fps)
			800 x 600 (30 fps)
	1280 x 720 (30 fps)	720 x 480 (30 fps)	720 x 480 (30 fps)
			640 x 480 (30 fps)
			352 x 240 (30 fps)
	1024 x 768 (30 fps)	800 x 600 (30 fps)	800 x 600 (30 fps)
			720 x 480 (30 fps)
			640 x 480 (30 fps)
			352 x 240 (30 fps)
	800 x 600 (30 fps)	800 x 600 (30 fps)	720 x 480 (30 fps)
			640 x 480 (30 fps)
			352 x 240 (30 fps)
	720 x 480 (30 fps)	720 x 480 (30 fps)	640 x 480 (30 fps)
			640 x 480 (30 fps)
			352 x 240 (30 fps)
	640 x 480 (30 fps)	640 x 480 (30 fps)	640 x 480 (30 fps)
352 x 240 (30 fps)			
1920 x 1080 (30 fps)	352 x 240 (30 fps)	352 x 240 (30 fps)	
1280 x 1024 (15 fps)	1280 x 1024 (15 fps)	1280 x 720 (30 fps)	
		800 x 600 (30 fps)	
	1280 x 1024 (30 fps)	720 x 480 (30 fps)	720 x 480 (30 fps)
			640 x 480 (30 fps)
			352 x 240 (30 fps)
	1280 x 720 (15 fps)	1280 x 720 (30 fps)	1280 x 720 (30 fps)
			800 x 600 (30 fps)
	1280 x 720 (30 fps)	720 x 480 (30 fps)	720 x 480 (30 fps)
			640 x 480 (30 fps)
	1024 x 768 (30 fps)	800 x 600 (30 fps)	800 x 600 (30 fps)
720 x 480 (30 fps)			

H.264-1 + H.264-2 + H.264-3 / MJPEG		
H.264-1	H.264-2	H.264-3 / MJPEG
1280 x 1024 (30 fps)	1280 x 720 (30 fps)	352 x 240 (30 fps)
	1024 x 768 (30 fps)	640 x 480 (30 fps)
		352 x 240 (30 fps)
	800 x 600 (30 fps)	800 x 600 (30 fps)
		720 x 480 (30 fps)
		640 x 480 (30 fps)
	720 x 480 (30 fps)	352 x 240 (30 fps)
720 x 480 (30 fps)		
640 x 480 (30 fps)		
640 x 480 (30 fps)	640 x 480 (30 fps)	
352 x 240 (30 fps)	352 x 240 (30 fps)	
1280 x 720 (15 fps)	1280 x 720 (30 fps)	1280 x 720 (30 fps)
1280 x 720 (30 fps)	1280 x 720 (30 fps)	800 x 600 (30 fps)
		720 x 480 (30 fps)
		640 x 480 (30 fps)
		352 x 240 (30 fps)
	1024 x 768 (30 fps)	800 x 600 (30 fps)
		720 x 480 (30 fps)
		640 x 480 (30 fps)
		352 x 240 (30 fps)
	800 x 600 (30 fps)	800 x 600 (30 fps)
		720 x 480 (30 fps)
		640 x 480 (30 fps)
		352 x 240 (30 fps)
	720 x 480 (30 fps)	720 x 480 (30 fps)
		640 x 480 (30 fps)
352 x 240 (30 fps)		
640 x 480 (30 fps)		
640 x 480 (30 fps)	352 x 240 (30 fps)	
	352 x 240 (30 fps)	
352 x 240 (30 fps)	352 x 240 (30 fps)	
1024 x 768 (30 fps)	1024 x 768 (30 fps)	800 x 600 (30 fps)
		720 x 480 (30 fps)
		640 x 480 (30 fps)
		352 x 240 (30 fps)
	800 x 600 (30 fps)	800 x 600 (30 fps)
		720 x 480 (30 fps)
		640 x 480 (30 fps)
	720 x 480 (30 fps)	352 x 240 (30 fps)
		720 x 480 (30 fps)
		640 x 480 (30 fps)
640 x 480 (30 fps)	640 x 480 (30 fps)	
	352 x 240 (30 fps)	
352 x 240 (30 fps)	352 x 240 (30 fps)	
800 x 600 (30 fps)	800 x 600 (30 fps)	800 x 600 (30 fps)
		720 x 480 (30 fps)
		640 x 480 (30 fps)
		352 x 240 (30 fps)
	720 x 480 (30 fps)	720 x 480 (30 fps)
		640 x 480 (30 fps)
		352 x 240 (30 fps)
		640 x 480 (30 fps)
640 x 480 (30 fps)	352 x 240 (30 fps)	
	352 x 240 (30 fps)	
352 x 240 (30 fps)	352 x 240 (30 fps)	

H.264-1 + H.264-2 + H.264-3 / MJPEG			
H.264-1	H.264-2	H.264-3 / MJPEG	
720 x 480 (30 fps)	720 x 480 (30 fps)	720 x 480 (30 fps)	
		640 x 480 (30 fps)	
		352 x 240 (30 fps)	
	640 x 480 (30 fps)	640 x 480 (30 fps)	640 x 480 (30 fps)
			352 x 240 (30 fps)
			352 x 240 (30 fps)
640 x 480 (30 fps)	640 x 480 (30 fps)	640 x 480 (30 fps)	
		352 x 240 (30 fps)	
		352 x 240 (30 fps)	
352 x 240 (30 fps)	352 x 240 (30 fps)	352 x 240 (30 fps)	

Dual Streams

H.264-1 + H.264-2 / MJPEG		
H.264-1	H.264-2 / MJPEG	BNC SUPPORT
2592 x 1944 (12 fps)	720 x 480 (12 fps)	-
	640 x 480 (12 fps)	-
	352 x 240 (12 fps)	-
2048 x 1536 (15 fps)	1280 x 720 (15 fps)	-
	800 x 600 (15 fps)	-
	720 x 480 (15 fps)	-
	640 x 480 (15 fps)	-
	352 x 240 (15 fps)	-
1920 x 1080 (15 fps)	1920 x 1080 (15 fps)	√
	1280 x 1024 (30 fps)	-
	1280 x 720 (30 fps)	-
	1024 x 768 (30 fps)	-
	800 x 600 (30 fps)	-
1920 x 1080 (30 fps)	720 x 480 (30 fps)	√
	640 x 480 (30 fps)	√
	352 x 240 (30 fps)	√
1280 x 1024 (30 fps)	1280 x 1024 (15 fps)	√
	1280 x 720 (30 fps)	-
	1024 x 768 (30 fps)	-
	800 x 600 (30 fps)	-
	720 x 480 (30 fps)	√
	640 x 480 (30 fps)	√
	352 x 240 (30 fps)	√
1280 x 720 (30 fps)	1280 x 720 (30 fps)	√
	1024 x 768 (30 fps)	-
	800 x 600 (30 fps)	-
	720 x 480 (30 fps)	√
	640 x 480 (30 fps)	√
	352 x 240 (30 fps)	√
1024 x 768 (30 fps)	1024 x 768 (30 fps)	√
	800 x 600 (30 fps)	-
	720 x 480 (30 fps)	√
	640 x 480 (30 fps)	√
	352 x 240 (30 fps)	√
800 x 600 (30 fps)	800 x 600 (30 fps)	√
	720 x 480 (30 fps)	√
	640 x 480 (30 fps)	√
	352 x 240 (30 fps)	√
720 x 480 (30 fps)	720 x 480 (30 fps)	√
	640 x 480 (30 fps)	√
	352 x 240 (30 fps)	√
640 x 480 (30 fps)	640 x 480 (30 fps)	√
	352 x 240 (30 fps)	√
352 x 240 (30 fps)	352 x 240 (30 fps)	-

Single Stream

H.264 Only	BNC SUPPORT
2592 x 1944 (12 fps)	-
2048 x 1536 (15 fps)	-
1920 x 1080 (30 fps) Low Latency*	-
1920 x 1080 (30 fps)	√
1280 x 1024 (30 fps)	√
1280 x 720 (30 fps)	√
1024 x 768 (30 fps)	√
800 x 600 (30 fps)	√
720 x 480 (30 fps)	√
640 x 480 (30 fps)	√
352 x 240 (30 fps)	-

* 1920 x 1080 (30 fps) Low Latency does not support BNC, 3DNR, Motion Detection and digital zoom.

MJPEG Only	BNC SUPPORT
1920 x 1080 (30 fps)	√
1280 x 1024 (30 fps)	√
1280 x 720 (30 fps)	√
1024 x 768 (30 fps)	√
800 x 600 (30 fps)	√
720 x 480 (30 fps)	√
640 x 480 (30 fps)	√
352 x 240 (30 fps)	-