



EMC TEST REPORT

According to

EN 55022:2010/AC:2011 (Class A)	EN 55024 : 2010
AS/NZS CISPR 22:2009 (Class A)	IEC 61000-4-2 : 2008
EN 61000-3-2 : 2006/A1: 2009/A2: 2009	IEC 61000-4-3 : 2010
EN 61000-3-3 : 2008	IEC 61000-4-4 : 2011
	IEC 61000-4-5 : 2005
	IEC 61000-4-6 : 2008
	IEC 61000-4-8 : 2009
	IEC 61000-4-11 : 2004

Applicant : VIVOTEK INC.

Address : 6F, No.192, Lien-Cheng Rd., Chung-Ho ,
New Taipei City, 235, Taiwan, R.O.C.

Equipment : Network Video Recorder

Model No. : NR8401

Trade Name : VIVOTEK

- The test result refers exclusively to the test presented test model / sample.
- Without written approval of *CerpPASS Technology Corp.* the test report shall not be reproduced except in full.
- This test report is only applicable to European Community.



Contents

CERTIFICATE OF COMPLIANCE	5
1. Summary of Test Procedure and Test Results	6
2. Immunity Testing Performance Criteria Definition	6
3. Test Configuration of Equipment under Test	7
3.1. Feature of Equipment under Test.....	7
3.2. Test Manner	7
3.3. Description of Support Unit	8
3.4. General Information of Test.....	9
3.5. Measurement Uncertainty	9
4. Test of Conducted Emission	10
4.1. Test Limit	10
4.2. Test Procedures	11
4.3. Typical Test Setup	11
4.4. Measurement Equipment.....	11
4.5. Test Result and Data.....	12
4.6. Test Photographs of Power Port Test.....	17
4.7. Test Photographs of Telecommunication Port.....	18
5. Test of Radiated Emission	19
5.1. Test Limit.....	19
5.2. Test Procedures	20
5.3. Typical Test Setup	21
5.4. Measurement Equipment.....	21
5.5. Test Result and Data (30MHz~1000MHz)	22
5.6. Test Result and Data (1000MHz~6000MHz)	26
5.7. Test Photographs (30MHz-1000MHz).....	28
5.8. Test Photographs (1000MHz~6000MHz).....	29
6. Harmonics Test	30
6.1. Limits of Harmonics Current Measurement	30
6.2. Test Result and Data.....	30
7. Voltage Fluctuations Test	31
7.1. Test Procedure	31
7.2. Measurement Equipment.....	31
7.3. Test Result and Data.....	32
7.4. Test Photographs	33
8. Electrostatic Discharge Immunity Test	34
8.1. Test Procedure	34
8.2. Test Setup for Tests Performed in Laboratory.....	35
8.3. Test Severity Levels	36
8.4. Measurement Equipment.....	36
8.5. Test Result and Data.....	37
8.6. Test Photographs	38
9. Radio Frequency electromagnetic field immunity test	39
9.1. Test Procedure	39



- 9.2. Test Severity Levels 39
- 9.3. Measurement Equipment..... 39
- 9.4. Test Result and Data..... 40
- 9.5. Test Photographs 41
- 10. Electrical Fast Transient/ Burst Immunity Test..... 44**
 - 10.1. Test Procedure 44
 - 10.2. Test Severity Levels 44
 - 10.3. Measurement Equipment..... 44
 - 10.4. Test Result and Data..... 45
 - 10.5. Test Photographs 46
- 11. Surge Immunity Test..... 47**
 - 11.1. Test Procedure 47
 - 11.2. Test Severity Level 47
 - 11.1. Measurement Equipment..... 48
 - 11.2. Test Result and Data..... 48
 - 11.3. Test Photographs 49
- 12. Conduction Disturbances induced by Radio-Frequency Fields 50**
 - 12.1. Test Procedure 50
 - 12.2. Test Severity Levels 50
 - 12.3. Measurement Equipment..... 50
 - 12.4. Test Result and Data..... 51
 - 12.5. Test Photographs 52
- 13. Power Frequency Magnetic Field Immunity Test..... 53**
 - 13.1. Test Setup 53
 - 13.2. Test Severity Levels 53
 - 13.3. Measurement Equipment..... 53
 - 13.4. Test Result and Data..... 54
 - 13.5. Test Photographs 55
- 14. Voltage Dips and Voltage Interruptions Immunity Test Setup 56**
 - 14.1. Test Conditions..... 56
 - 14.1. Measurement Equipment..... 56
 - 14.2. Test Result and Data..... 57
 - 14.3. Test Photographs 58
- Appendix A. Photographs of EUT.....A1 ~ A4**



CERTIFICATE OF COMPLIANCE

According to

EN 55022:2010/AC:2011 (Class A)
AS/NZS CISPR 22:2009 (Class A)
EN 61000-3-2 : 2006/A1: 2009/A2: 2009
EN 61000-3-3 : 2008

EN 55024 : 2010
IEC 61000-4-2 : 2008
IEC 61000-4-3 : 2010
IEC 61000-4-4 : 2011
IEC 61000-4-5 : 2005
IEC 61000-4-6 : 2008
IEC 61000-4-8 : 2009
IEC 61000-4-11 : 2004

Applicant : VIVOTEK INC.

Address : 6F, No.192, Lien-Cheng Rd., Chung-Ho , New Taipei
City, 235, Taiwan, R.O.C.

Equipment : Network Video Recorder

Model No. : NR8401

I **HEREBY** CERTIFY THAT :

The measurements shown in this test report were made in accordance with the procedures given in **EUROPEAN COUNCIL DIRECTIVE 2004/108/EC**.

The test was carried out on Dec. 04, 2012 at **CerpPASS Technology Corp.**

Signature

Hill Chen
EMC/RF B.U. Assistant Manager



1. Summary of Test Procedure and Test Results

Test Item	Normative References	Test Result
Conducted Emission	EN 55022:2010	PASS
Radiated Emission	EN 55022:2010	PASS
Harmonics	EN 61000-3-2 : 2006/A1: 2009/A2: 2009	N/A
Voltage Fluctuations	EN 61000-3-3 : 2008	PASS
Electrostatic Discharge Immunity Test (ESD)	IEC 61000-4-2 : 2008	PASS
Radio Frequency electromagnetic field immunity test (RS)	IEC 61000-4-3 : 2010	PASS
Electrical Fast Transient/ Burst Immunity Test (EFT)	IEC 61000-4-4 : 2010	PASS
Surge Immunity Test	IEC 61000-4-5 : 2005	PASS
Conduction Disturbances induced by Radio-Frequency Fields	IEC 61000-4-6 : 2008	PASS
Power Frequency Magnetic Field Immunity Test	IEC 61000-4-8 : 2009	PASS
Voltage Dips and Voltage Interruptions Immunity Test	IEC 61000-4-11 : 2004	PASS

2. Immunity Testing Performance Criteria Definition

- A. Normal performance within limits specified by the manufacture, requestor or purchaser;
- B. Temporary loss of function or degradation of performance which ceases after the disturbance ceases, and from which the equipment under test recovers its normal performance, without operator intervention;
- C. Temporary loss of function or degradation of performance, the correction of which requires operation intervention;
- D. Loss of function or degradation of performance which is not recoverable, owing to damage to hardware or software, or loss of data.



3. Test Configuration of Equipment under Test

3.1. Feature of Equipment under Test

Refers to the user's manual.

3.2. Test Manner

- a. During testing, the interface cables and equipment positions were varied according to Europe Standard EN55022 Class A.
- b. The complete test system include remote workstation, Mouse, Printer, iPod*4, Notebook, E-SATA HDD*2, HDD*4, and EUT for EMI test. The remote workstation includes Notebook.
- c. The complete test system include remote workstation, notebook, Flash Memory*3, E-SATA HDD*2, HDD*4, and EUT for EMS test. The remote workstation includes Notebook.
- d. The result of Conduction, Radiation and EMS test as follow:
Test Mode 1. LINK LAN (1000Mbps) + R/W
- e. The result of disturbances at telecommunication ports test as follow:
Test Mode 1. ISN LAN1 (1000Mbps)
Test Mode 2. ISN LAN2 (1000Mbps)
Test Mode 3. ISN LAN1(100Mbps)
Test Mode 4. ISN LAN1(10Mbps)
Test Mode1, 3-4 generate the worst cases; they are reported as final result.
- f. The EUT was executed under Linux to read and write data.
- g. During the disturbances at telecommunication port test, the condition of LAN utilization in excess of 10%.
- h. An executive program, "PING.EXE" under WIN7 was executed to transmit and receive data from remote workstation to the EUT through LAN.



3.3. Description of Support Unit

EMI :

Device	Manufacturer	Model No.	Description
Mouse	DELL	MOC5UO	Data Cable, USB Shielding, 1.85m
Printer	HP	D2260	Data Cable, USB Shielding, 1.6m
iPod*4	APPLE	A1320	Data Cable, USB Shielding, 1m
Notebook	SONY	VPCEB25FW	Power Cable, Adapter Unshielding 1.8m
E-SATA HDD*2	WD	MY book 2TB	Data Cable, E-SATA Shielding, 1.0m Power Cable, Adapter Unshielding, 1.8m
HDD*3	WD	WD2002FAZX	Data Cable, SATA Shielding, 0.5m
HDD	Seagate	ST2000DM001	Data Cable, SATA Shielding, 0.5m
Remote Workstation			
Notebook	SONY	VPCEB25FW	Power Cable, Adapter Unshielding 1.8m

Use Cable:

Cable	Quantity	Description
RJ45	1	Unshielding, 15m
RJ45	1	Unshielding, 1.8m
USB to RS232	1	Unshielding, 1.8m
Floating	16	Unshielding, 0.1m

EMS:



Device	Manufacturer	Model No.	Description
Notebook	SONY	VPCEB25FW	Power Cable, Adapter Unshielding 1.8m
Flash Memory*3	TranScend	JF150 2GB	N/A
E-SATA HDD*2	WD	MY book 2TB	Data Cable, E-SATA Shielding, 1.0m Power Cable, Adapter Unshielding, 1.8m
HDD*3	WD	WD2002FAZX	Data Cable, SATA Shielding, 0.5m
HDD	Seagate	ST2000DM001	Data Cable, SATA Shielding, 0.5m
Remote Workstation			
Notebook	SONY	VPCEB25FW	Power Cable, Adapter Unshielding 1.8m

Use Cable:

Cable	Quantity	Description
RJ45	1	Unshielding, 15m
RJ45	1	Unshielding, 1.8m
USB to RS232	1	Unshielding, 1.8m
Floating	16	Unshielding, 0.1m



3.4. General Information of Test

Test Site :	Cerpass Technology Corp. 2F-11, No. 3, Yuan Qu St., (Nankang Software Park), Taipei, Taiwan 115, R.O.C.
Test Site Location (OATS2-SD) :	No.68-1, Shihbachongsi, Shihding Township, Taipei City 223, Taiwan, R.O.C.
FCC Registration Number :	TW1049, TW1061, 390316, 488071
IC Registration Number :	4934B-1, 4934D-1
VCCI Registration Number :	T-1173 for Telecommunication Test C-4139 for Conducted emission test R-3428 for Radiated emission test G-97 for Radiated emission test above 1GHz
Frequency Range Investigated :	Conducted Emission Test: from 150kHz to 30 MHz Radiated Emission Test: from 30 MHz to 6,000 MHz
Test Distance :	The test distance of radiated emission below 1GHz from antenna to EUT is 10 M. The test distance of radiated emission above 1GHz from antenna to EUT is 3 M.
Laboratory Accreditation	 

3.5. Measurement Uncertainty

Measurement Item	Measurement Frequency	Polarization	Uncertainty
Conducted Emission	9 kHz ~ 30 MHz	LINE / NEUTRAL	3.25 dB
Radiated Emission	30 MHz ~ 1,000 MHz	Vertical / Horizontal	3.93 dB
	1,000 MHz ~ 18,000 MHz	Vertical / Horizontal	5.18 dB



4. Test of Conducted Emission

4.1. Test Limit

Conducted Emissions were measured from 150 kHz to 30 MHz with a bandwidth of 9 kHz and return leads of the EUT according to the methods defined in European Standard EN 55022. The EUT was placed on a nonmetallic stand in a shielded room 0.8 meters above the ground plane as shown in section 4.2. The interface cables and equipment positioning were varied within limits of reasonable applications to determine the position producing maximum conducted emissions.

Table 1 Class A Line Conducted Emission Limits:

Frequency range (MHz)	Limits (dB μ V)	
	Quasi Peak	Average
0.15 to 0.50	79	66
0.50 to 30	73	60

Note : The lower limits shall apply at the transition frequencies.

Table 2 - Limits of conducted common mode (asymmetric mode) disturbance at telecommunication ports in the frequency range 0.15 MHz to 30 MHz for class A equipment.

Frequency range (MHz)	Voltage limits dB(μ V)		Current limits dB(μ A)	
	Quasi-peak	Average	Quasi-peak	Average
0.15 to 0.5	97 to 87	84 to 74	53 to 43	40 to 30
0.5 to 30	87	74	43	30

Note 1: The limits decrease linearly with the logarithm of the frequency in the range 0.15 to 0.5 MHz.
 Note 2 : The current and voltage disturbance limits are derived for use with an impedance stabilization network (ISN) which presents a common mode (asymmetric mode) impedance of 150Ω to the telecommunication under test (conversion factor is $20 \log_{10} 150/1 = 44\text{dB}$).

4.2. Test Procedures

- a. The EUT was placed on a desk 0.8 meters height from the metal ground plane and 0.4 meter from the conducting wall of the shielding room and it was kept at least 0.8 meters from any other grounded conducting surface.
- b. Connect EUT to the power mains through a line impedance stabilization network (LISN).
- c. All the support units are connecting to the other LISN.
- d. The LISN provides 50 ohm coupling impedance for the measuring instrument.
- e. The CISPR states that a 50 ohm, 50 micro-Henry LISN should be used.
- f. Both sides of AC line were checked for maximum conducted interference.
- g. The frequency range from 150 kHz to 30 MHz was searched
- h. Set the test-receiver system to Peak Detect Function and Specified Bandwidth with Maximum Hold Mode.

4.3. Typical Test Setup

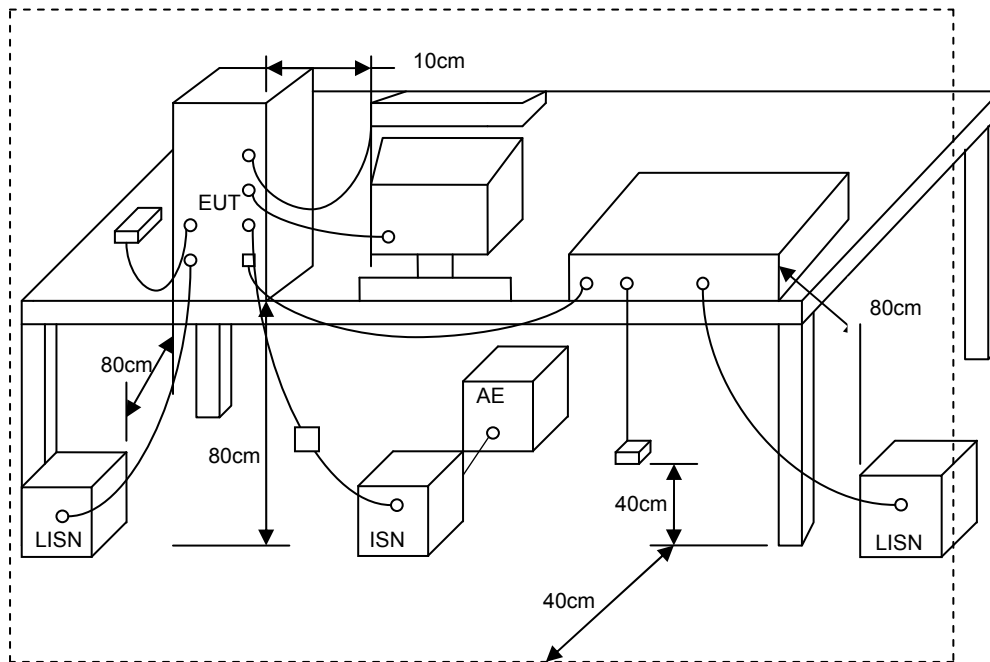

4.4. Measurement Equipment

Instrument	Manufacturer	Model No.	Serial No.	Calibration Date	Valid Date
EMI Receiver	R&S	ESCI	100443	2012/01/12	2013/01/11
LISN	Schwarzbeck	NSLK 8127	8127-516	2012/03/08	2013/03/07
LISN	Schwarzbeck	NSLK 8127	8127-568	2012/08/22	2013/08/21
ISN	TESEQ GMBH	ISN T8	24315	2012/09/28	2013/09/27



4.5. Test Result and Data

4.5.1 Conducted Emission for Power Port Test Data

Power	: AC 230V	Pol/Phase	: LINE
Test Mode 1	: Link LAN 1Gbps+ R/W	Temperature	: 22 °C
Test Date	: 2012/11/29	Humidity	: 70 %

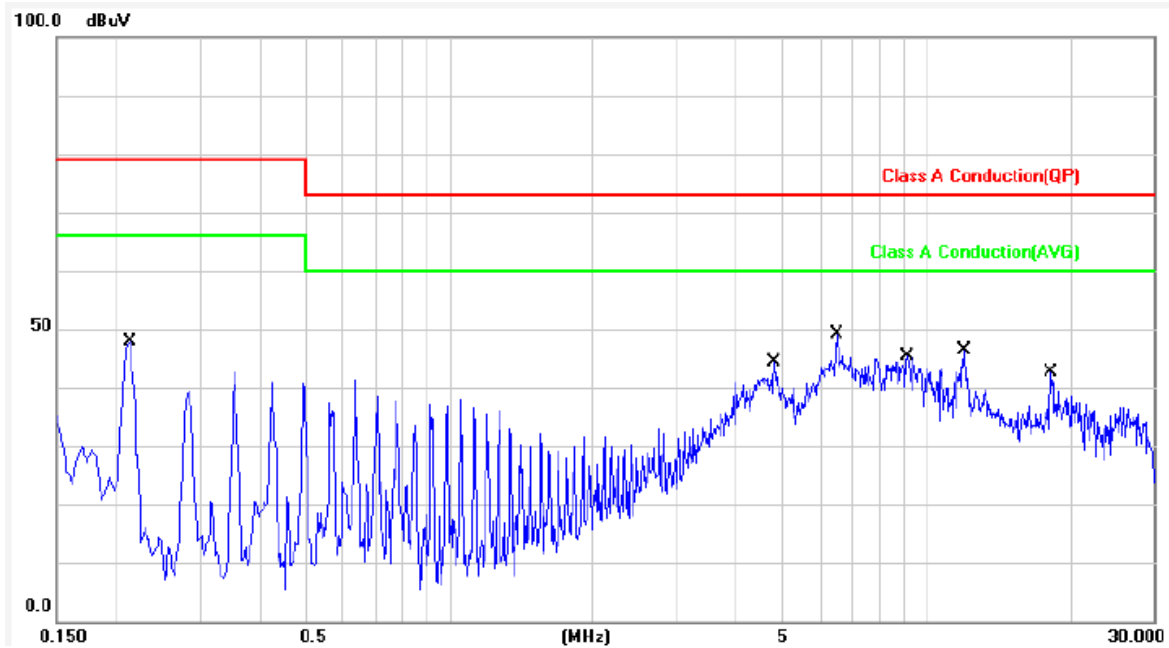

No.	Frequency (MHz)	Factor (dB)	Reading (dBUV)	Level (dBUV)	Limit (dBUV)	Margin (dB)	Detector	P/F
1	0.2140	0.12	46.82	46.94	79.00	-32.06	QP	P
2	0.2140	0.12	43.34	43.46	66.00	-22.54	AVG	P
3	4.8100	0.47	40.37	40.84	73.00	-32.16	QP	P
4	4.8100	0.47	34.93	35.40	60.00	-24.60	AVG	P
5	6.5180	0.54	41.36	41.90	73.00	-31.10	QP	P
6	6.5180	0.54	35.90	36.44	60.00	-23.56	AVG	P
7	9.1459	0.64	42.35	42.99	73.00	-30.01	QP	P
8	9.1459	0.64	33.34	33.98	60.00	-26.02	AVG	P
9	11.9980	0.75	44.63	45.38	73.00	-27.62	QP	P
10	11.9980	0.75	43.56	44.31	60.00	-15.69	AVG	P
11	18.2460	1.00	40.27	41.27	73.00	-31.73	QP	P
12	18.2460	1.00	36.81	37.81	60.00	-22.19	AVG	P

Note: Level = Reading + Factor
Margin = Level – Limit



4.5.2 Conducted Emission for Telecommunication Port Test Data

Power	: AC 230V	Temperature	: 22 °C
Test Mode 1	: ISN LAN1 (1000Mbps)	Humidity	: 70 %
Test Date	: 2012/11/29		

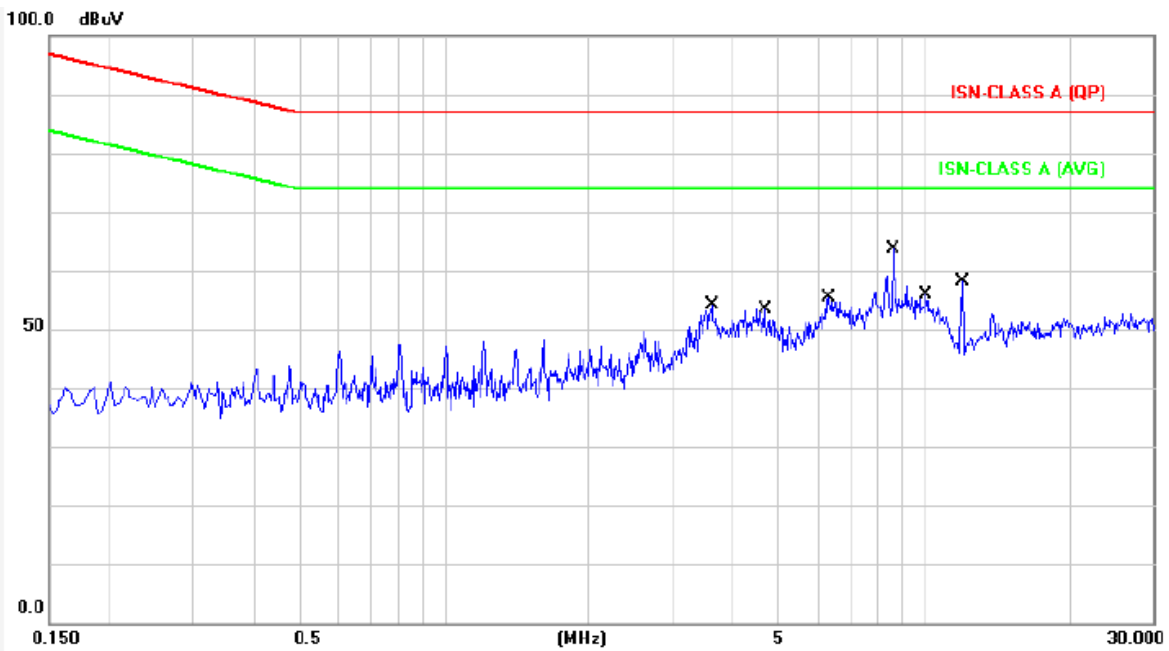

No.	Frequency (MHz)	Factor (dB)	Reading (dBuV)	Level (dBuV)	Limit (dBuV)	Margin (dB)	Detector	P/F
1	3.6180	9.81	36.92	46.73	87.00	-40.27	QP	P
2	3.6180	9.81	31.04	40.85	74.00	-33.15	AVG	P
3	4.6620	9.82	33.62	43.44	87.00	-43.56	QP	P
4	4.6620	9.82	28.10	37.92	74.00	-36.08	AVG	P
5	6.3500	9.83	37.61	47.44	87.00	-39.56	QP	P
6	6.3500	9.83	32.41	42.24	74.00	-31.76	AVG	P
7	8.6620	9.87	42.34	52.21	87.00	-34.79	QP	P
8	8.6620	9.87	37.15	47.02	74.00	-26.98	AVG	P
9	10.0780	9.88	41.17	51.05	87.00	-35.95	QP	P
10	10.0780	9.88	36.11	45.99	74.00	-28.01	AVG	P
11	12.0020	9.90	46.35	56.25	87.00	-30.75	QP	P
12	12.0020	9.90	45.58	55.48	74.00	-18.52	AVG	P

Note: Level = Reading + Factor
Margin = Level – Limit



Power	: AC 230V	Temperature	: 22 °C
Test Mode 3	: ISN LAN1 (100Mbps)	Humidity	: 70 %
Test Date	: 2012/11/29		

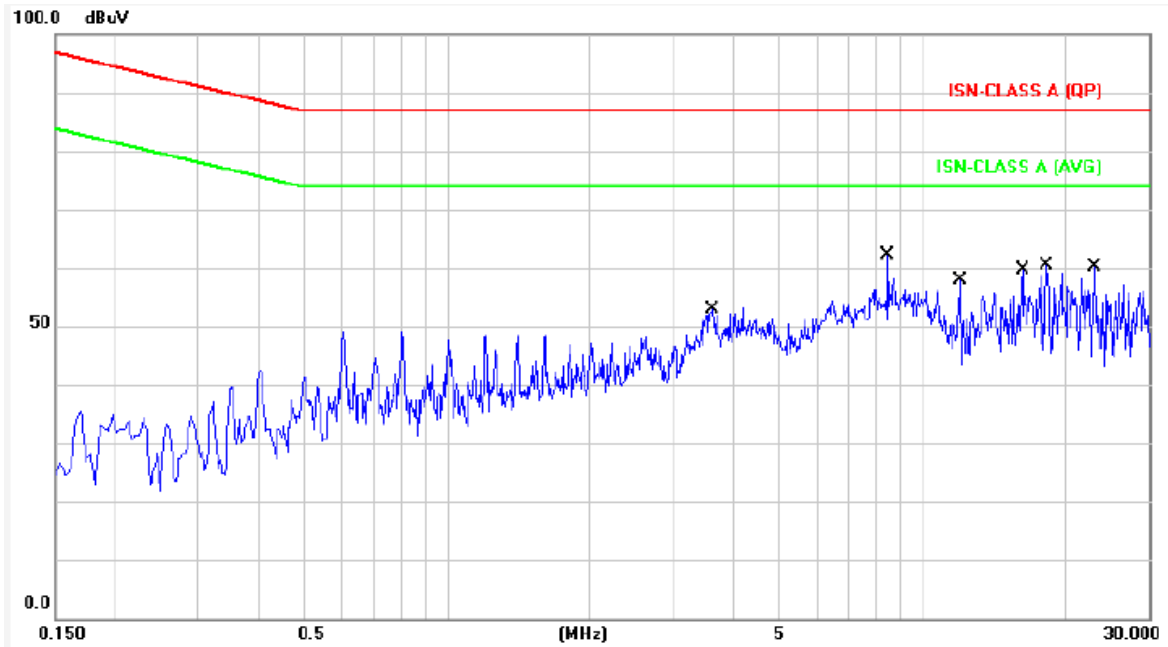

No.	Frequency (MHz)	Factor (dB)	Reading (dBuV)	Level (dBuV)	Limit (dBuV)	Margin (dB)	Detector	P/F
1	3.6380	9.81	37.20	47.01	87.00	-39.99	QP	P
2	3.6380	9.81	31.43	41.24	74.00	-32.76	AVG	P
3	8.4819	9.86	42.41	52.27	87.00	-34.73	QP	P
4	8.4819	9.86	35.90	45.76	74.00	-28.24	AVG	P
5	12.0020	9.90	46.51	56.41	87.00	-30.59	QP	P
6	12.0020	9.90	45.96	55.86	74.00	-18.14	AVG	P
7	16.2300	9.95	48.73	58.68	87.00	-28.32	QP	P
8	16.2300	9.95	46.29	56.24	74.00	-17.76	AVG	P
9	18.2460	9.99	49.53	59.52	87.00	-27.48	QP	P
10	18.2460	9.99	47.11	57.10	74.00	-16.90	AVG	P
11	23.1299	10.08	49.76	59.84	87.00	-27.16	QP	P
12	23.1299	10.08	46.59	56.67	74.00	-17.33	AVG	P

Note: Level = Reading + Factor
Margin = Level – Limit



Power	: AC 230V	Temperature	: 22 °C
Test Mode 4	: ISN LAN1 (10Mbps)	Humidity	: 70 %
Test Date	: 2012/11/29		

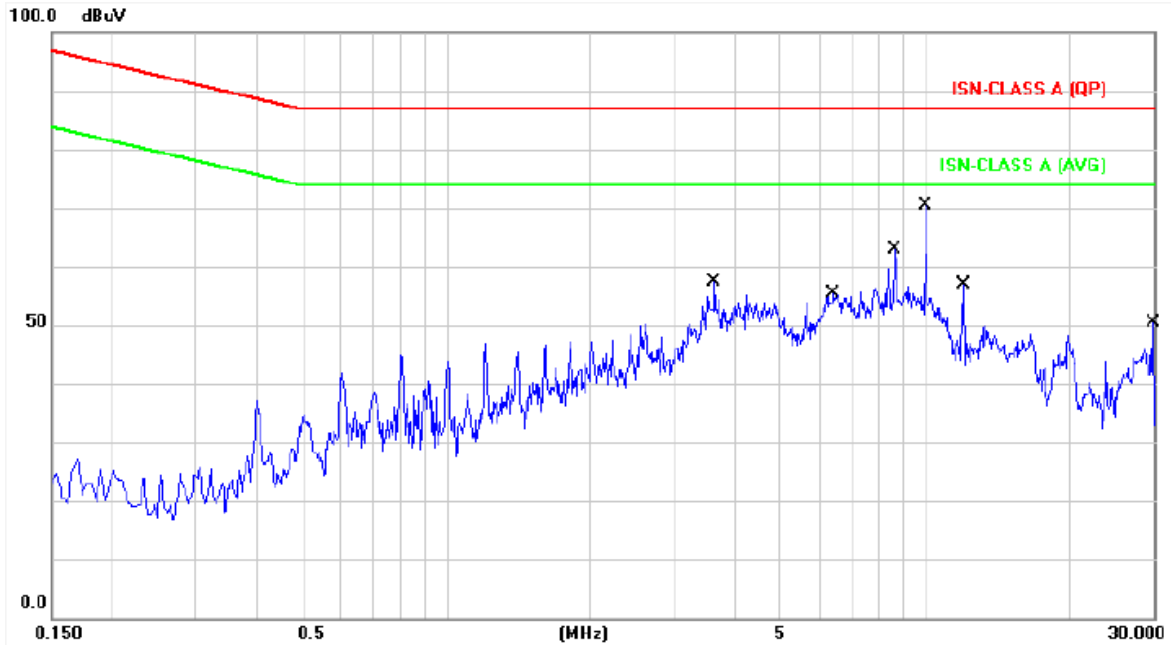

No.	Frequency (MHz)	Factor (dB)	Reading (dBuV)	Level (dBuV)	Limit (dBuV)	Margin (dB)	Detector	P/F
1	3.6380	9.81	39.24	49.05	87.00	-37.95	QP	P
2	3.6380	9.81	33.45	43.26	74.00	-30.74	AVG	P
3	6.4420	9.83	40.70	50.53	87.00	-36.47	QP	P
4	6.4420	9.83	35.36	45.19	74.00	-28.81	AVG	P
5	8.6580	9.87	43.62	53.49	87.00	-33.51	QP	P
6	8.6580	9.87	37.56	47.43	74.00	-26.57	AVG	P
7	10.0000	9.88	65.98	75.86	87.00	-11.14	QP	P
8	10.0000	9.88	48.45	58.33	74.00	-15.67	AVG	P
9	11.9980	9.90	47.00	56.90	87.00	-30.10	QP	P
10	11.9980	9.90	46.44	56.34	74.00	-17.66	AVG	P
11	29.9980	10.19	40.25	50.44	87.00	-36.56	QP	P
12	29.9980	10.19	25.00	35.19	74.00	-38.81	AVG	P

Note: Level = Reading + Factor

Margin = Level – Limit

Test engineer: Charlie



4.6. Test Photographs of Power Port Test

Front View



Rear View





4.7. Test Photographs of Telecommunication Port

Rear View

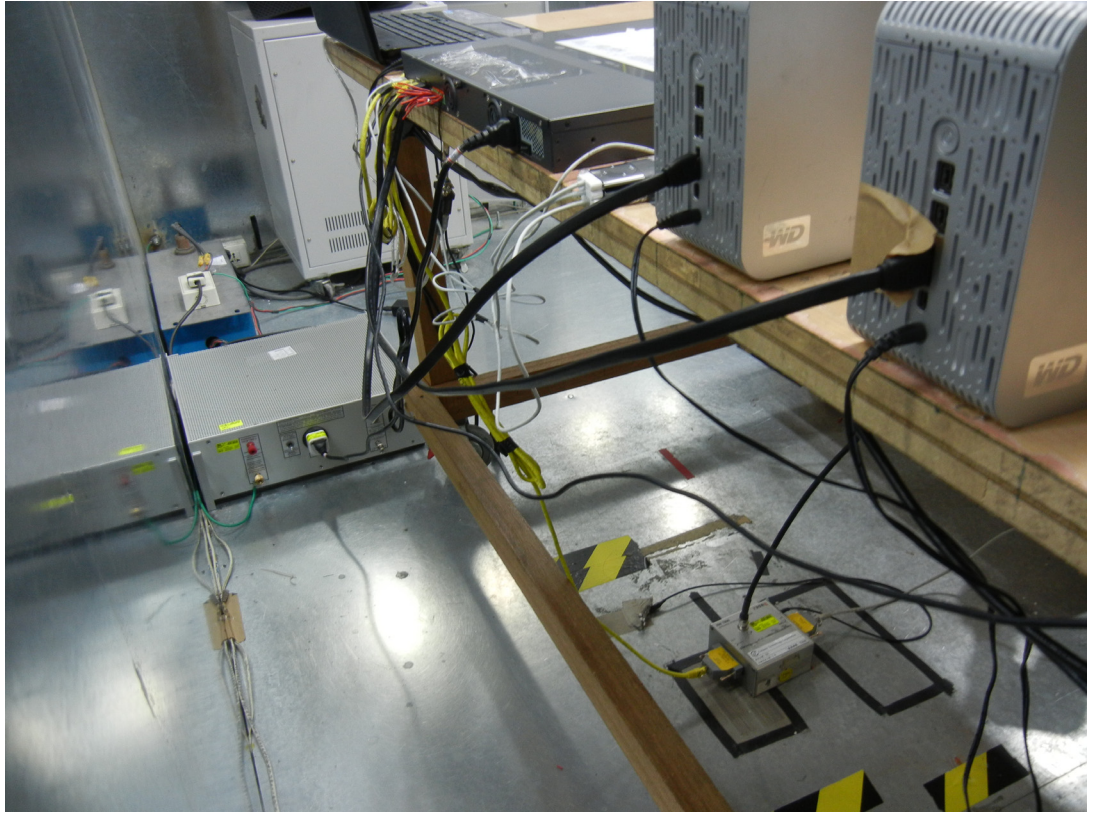



5. Test of Radiated Emission

5.1. Test Limit

The EUT shall meet the limits of below Table when measured at the measuring distance R in accordance with the methods described in European Standard EN 55022 Clause 10. If the reading on the measuring receiver shows fluctuations close to the limit, the reading shall be observed for at least 15 s at each measurement frequency; the highest reading shall be recorded, with the exception of any brief isolated high reading, which shall be ignored.

Table – Limits for radiated disturbance of class A ITE at a measuring distance of 10 m

Frequency range MHz	Quasi-peak limits dB(μ V/m)
30 to 230	40
230 to 1000	47
NOTE 1 The lower limit shall apply at the transition frequency.	
NOTE 2 Additional provisions may be required for cases where interference occurs.	

The EUT shall meet the limits of below Table when measured in accordance with the method described in European Standard EN 55022 Clause 10 and the conditional testing procedure described below.

Table – Limits for radiated disturbance of class A ITE at a measuring distance of 3 m

Frequency range GHz	Average limit dB(μ V/m)	Peak limits dB(μ V/m)
1 to 3	56	76
3 to 6	60	80
NOTE The lower limit applies at the transition frequency.		

• Conditional testing procedure:

The highest internal source of an EUT is defined as the highest frequency generated or used within the EUT or on which the EUT operates or tunes.

If the highest frequency of the internal sources of the EUT is less than 108 MHz, the measurement shall only be made up to 1 GHz.

If the highest frequency of the internal sources of the EUT is between 108 MHz and 500 MHz, the measurement shall only be made up to 2 GHz.

If the highest frequency of the internal sources of the EUT is between 500 MHz and 1 GHz, the measurement shall only be made up to 5 GHz.

If the highest frequency of the internal sources of the EUT is above 1 GHz, the measurement shall be made up to 5 times the highest frequency or 6 GHz, whichever is less.



5.2. Test Procedures

- a. The EUT was placed on a rotatable table top 0.8 meter above ground.
- b. The EUT was set 3/10 meters from the interference receiving antenna which was mounted on the top of a variable height antenna tower.
- c. The table was rotated 360 degrees to determine the position of the highest radiation.
- d. The antenna is a half wave dipole and its height is varied between one meter and four meters above ground to find the maximum value of the field strength both horizontal polarization and vertical polarization of the antenna are set to make the measurement.
- e. For each suspected emission the EUT was arranged to its worst case and then tune the antenna tower (from 1 M to 4 M) and turn table (from 0 degree to 360 degrees) to find the maximum reading.
- f. Set the test-receiver system to Peak Detect Function and specified bandwidth with Maximum Hold Mode.
- g. If the emission level of the EUT in peak mode was 3 dB lower than the limit specified, then testing will be stopped and peak values of EUT will be reported, otherwise, the emissions which do not have 3 dB margin will be repeated one by one using the quasi-peak method and reported.

5.3. Typical Test Setup

Below 1GHz Test Setup

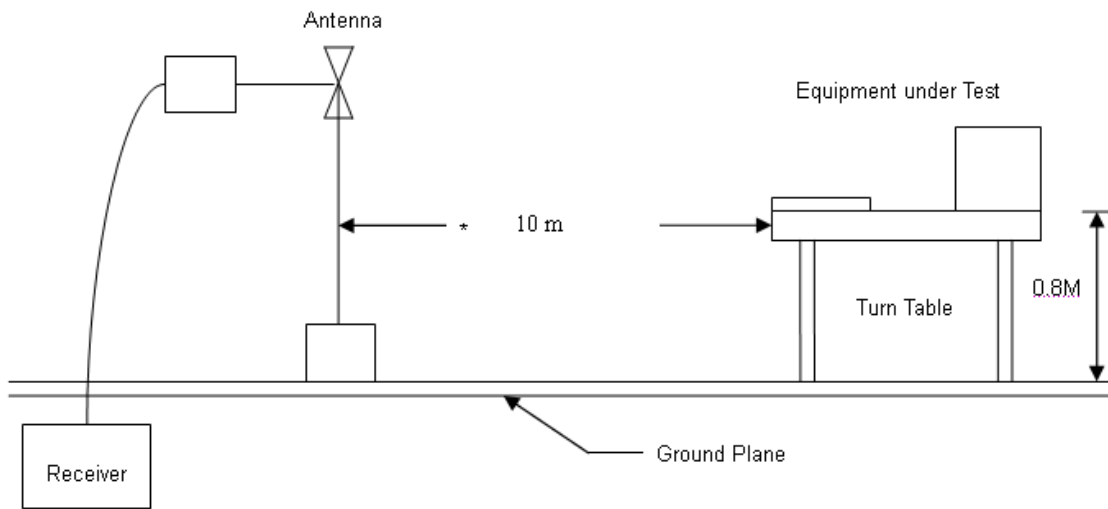

Above 1GHz Test Setup

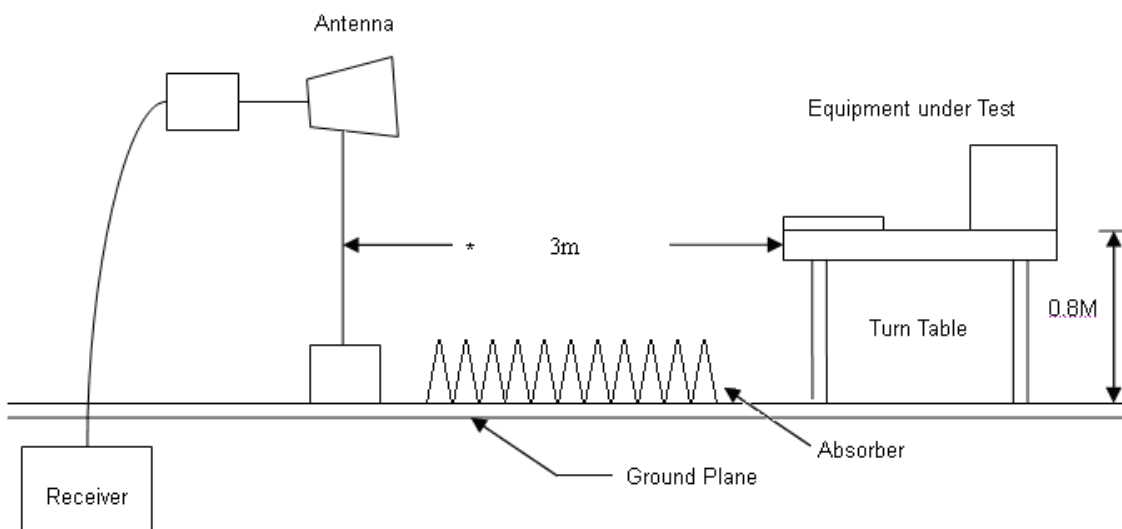

5.4. Measurement Equipment

Instrument	Manufacturer	Model No.	Serial No.	Calibration Date	Valid Date
Bilog Antenna	Schaffner	CBL6112B	2840	2012/03/23	2013/03/22
Amplifier	Agilent	8447D	2944A10593	2012/03/21	2013/03/20
EMI Receiver	HP	8546A/ 85460A	3807A00454/ 3704A00386	2012/08/22	2013/08/21
Spectrum Analyzer	R&S	FSP40	100047	2012/03/01	2013/02/28
Horn Antenna	EMCO	3115	31589	2012/03/01	2013/02/28
Preamplifier	Agilent	8449B	3008A01954	2012/02/29	2013/02/28



5.5. Test Result and Data (30MHz~1000MHz)

Power	: AC 230V	Pol/Phase	: VERTICAL
Test Mode 1	: LINK LAN (1000Mbps) + R/W	Temperature	: 25 °C
Test Date	: 2012/11/28	Humidity	: 63 %

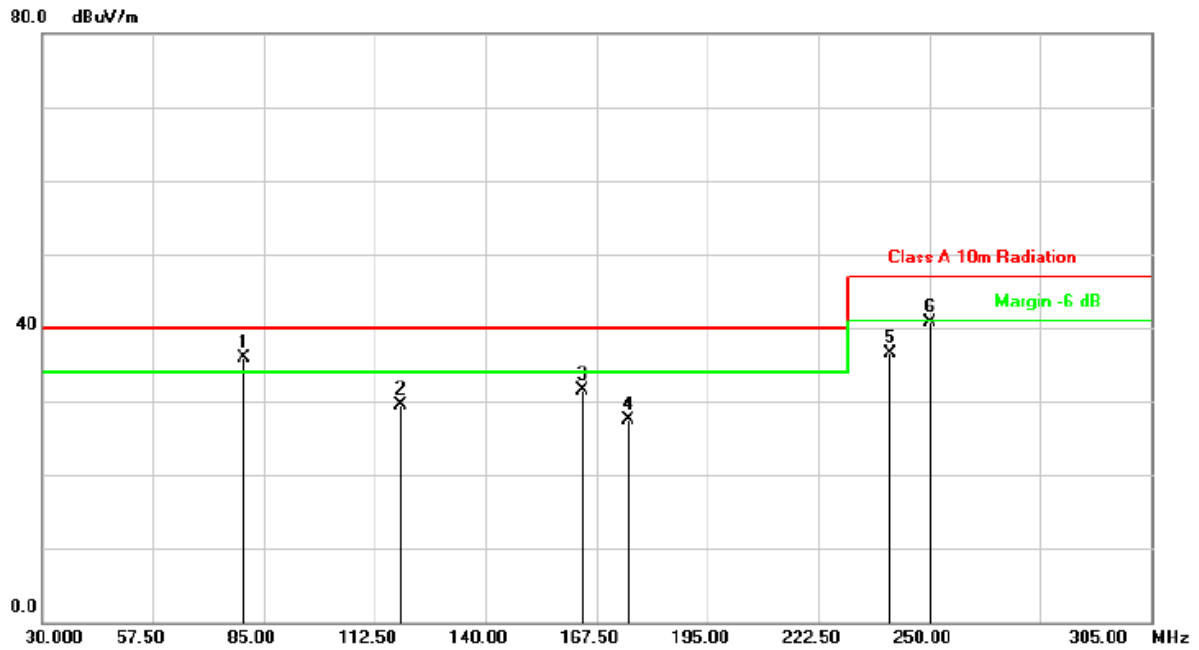

No.	Frequency (MHz)	Factor (dB/m)	Reading (dBuV)	Level (dBuV/m)	Limit (dBuV/m)	Margin (dB)	Detector	Height (cm)	Azimuth (°)	P/F
1	79.9630	-17.74	53.67	35.93	40.00	-4.07	QP	100	194	P
2	119.0574	-15.03	44.57	29.54	40.00	-10.46	QP	400	0	P
3	163.9500	-14.54	46.12	31.58	40.00	-8.42	QP	400	0	P
4	175.5640	-15.15	42.67	27.52	40.00	-12.48	QP	400	0	P
5	240.1520	-13.44	50.02	36.58	47.00	-10.42	QP	400	0	P
6	250.0000	-12.31	53.00	40.69	47.00	-6.31	QP	400	0	P

Note: Level = Reading + Factor
Margin = Level – Limit



Power	: AC 230V	Pol/Phase	: VERTICAL
Test Mode 1	: LINK LAN (1000Mbps) + R/W	Temperature	: 25 °C
Test Date	: 2012/11/28	Humidity	: 63 %

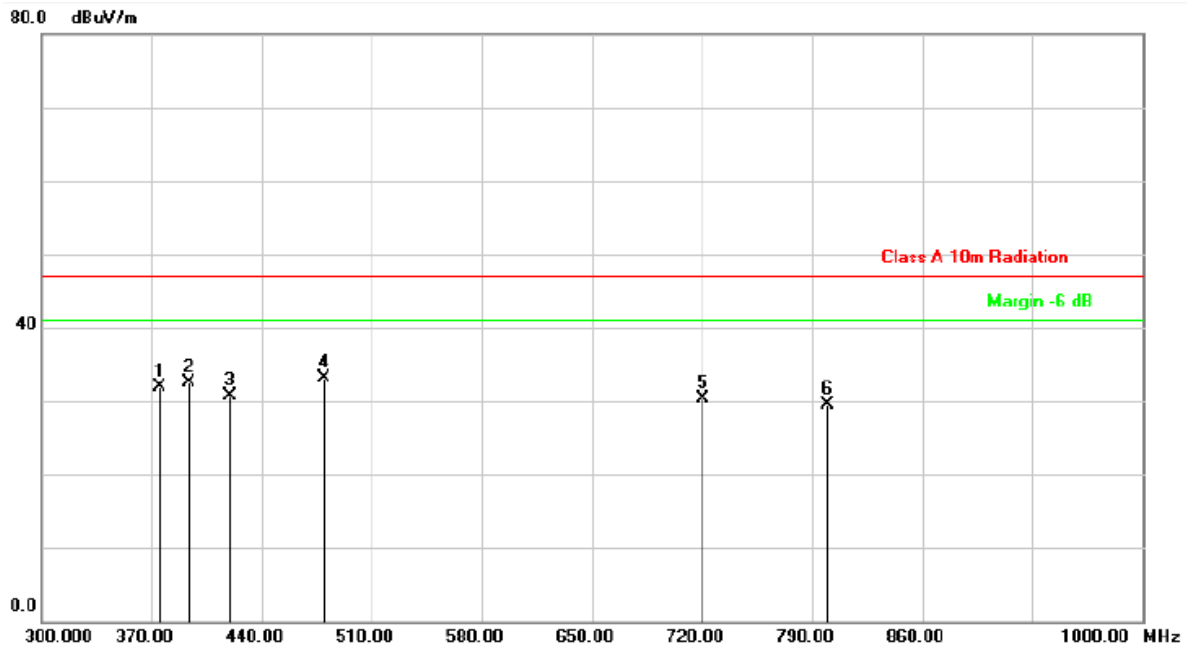

No.	Frequency (MHz)	Factor (dB/m)	Reading (dBuV)	Level (dBuV/m)	Limit (dBuV/m)	Margin (dB)	Detector	Height (cm)	Azimuth (°)	P/F
1	375.2510	-7.49	39.36	31.87	47.00	-15.13	QP	100	0	P
2	393.4200	-6.98	39.52	32.54	47.00	-14.46	QP	100	0	P
3	420.1470	-6.70	37.37	30.67	47.00	-16.33	QP	100	0	P
4	480.0000	-6.44	39.58	33.14	47.00	-13.86	QP	100	0	P
5	720.0000	-3.09	33.35	30.26	47.00	-16.74	QP	100	0	P
6	800.1579	-1.51	31.05	29.54	47.00	-17.46	QP	100	0	P

Note: Level = Reading + Factor
Margin = Level – Limit



Power	: AC 230V	Pol/Phase	: HORIZONTAL
Test Mode 1	: LINK LAN (1000Mbps) + R/W	Temperature	: 25 °C
Test Date	: 2012/11/28	Humidity	: 63 %

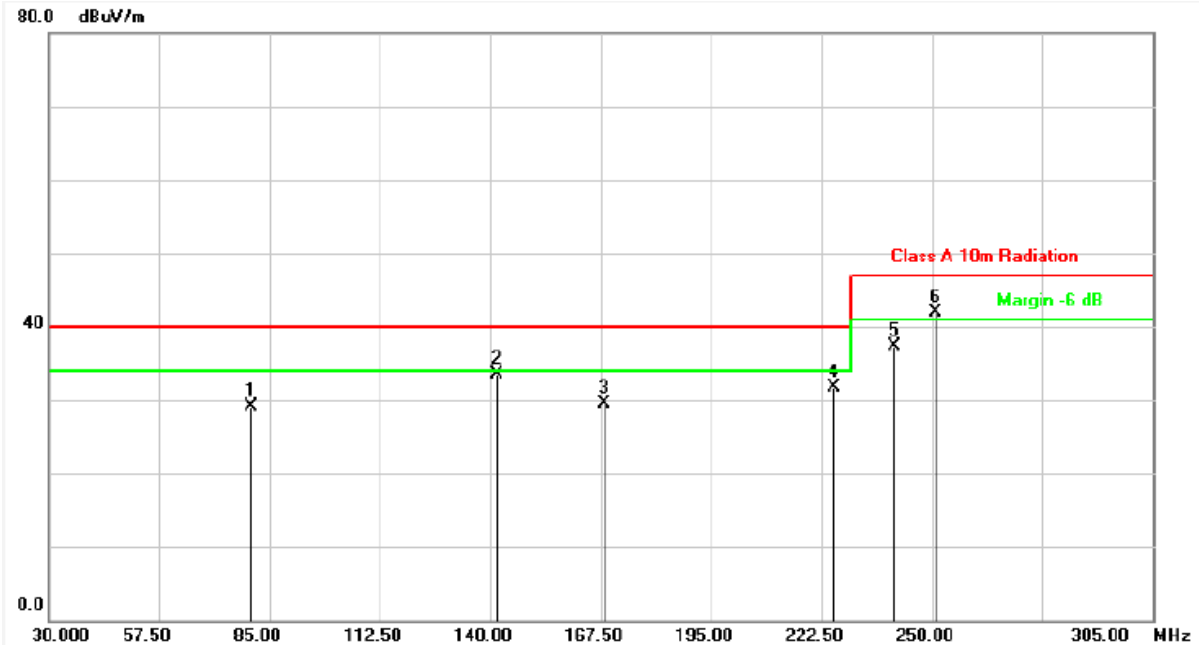

No.	Frequency (MHz)	Factor (dB/m)	Reading (dBuV)	Level (dBuV/m)	Limit (dBuV/m)	Margin (dB)	Detector	Height (cm)	Azimuth (°)	P/F
1	80.4120	-17.24	46.30	29.06	40.00	-10.94	QP	400	0	P
2	141.8209	-14.01	47.59	33.58	40.00	-6.42	QP	400	0	P
3	168.2540	-14.31	43.78	29.47	40.00	-10.53	QP	400	0	P
4	225.4780	-14.44	46.12	31.68	40.00	-8.32	QP	400	0	P
5	240.4790	-12.67	49.89	37.22	47.00	-9.78	QP	400	0	P
6	250.8200	-11.39	53.23	41.84	47.00	-5.16	QP	400	187	P

Note: Level = Reading + Factor
Margin = Level – Limit



Power	: AC 230V	Pol/Phase	: HORIZONTAL
Test Mode 1	: LINK LAN (1000Mbps) + R/W	Temperature	: 25 °C
Test Date	: 2012/11/28	Humidity	: 63 %

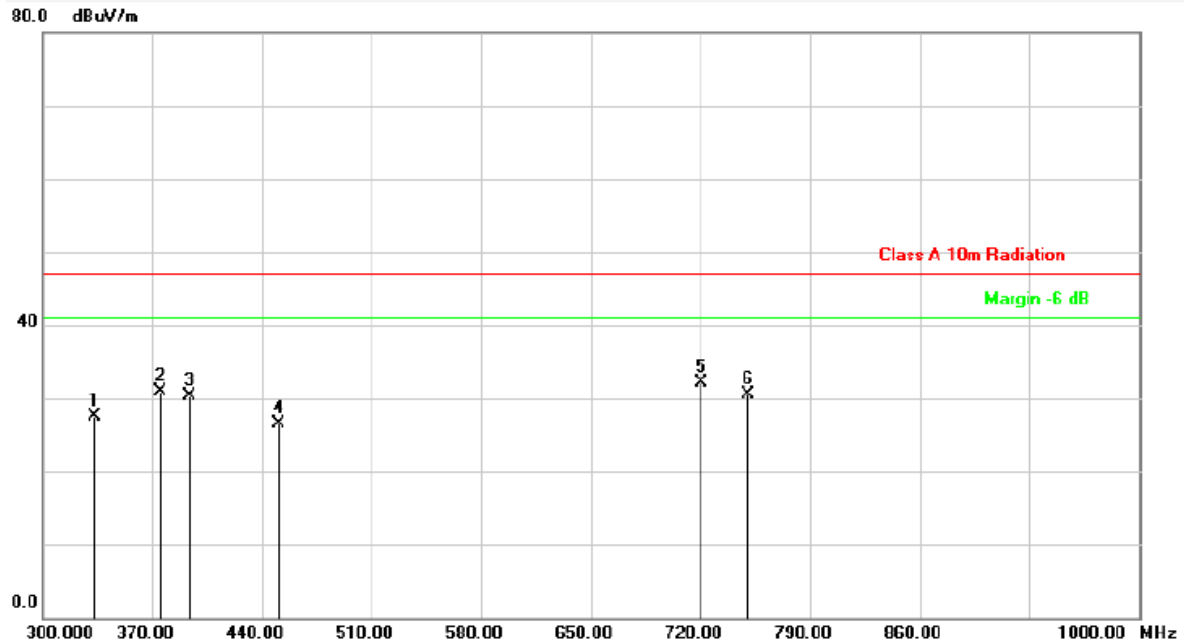

No.	Frequency (MHz)	Factor (dB/m)	Reading (dBuV)	Level (dBuV/m)	Limit (dBuV/m)	Margin (dB)	Detector	Height (cm)	Azimuth (°)	P/F
1	333.4100	-8.86	36.42	27.56	47.00	-19.44	QP	100	0	P
2	375.1000	-7.69	38.55	30.86	47.00	-16.14	QP	100	0	P
3	393.5080	-7.13	37.35	30.22	47.00	-16.78	QP	100	0	P
4	450.8400	-6.12	32.66	26.54	47.00	-20.46	QP	100	0	P
5	720.0000	-2.40	34.57	32.17	47.00	-14.83	QP	100	0	P
6	750.0470	-1.58	32.05	30.47	47.00	-16.53	QP	100	0	P

Note: Level = Reading + Factor
Margin = Level – Limit

Test engineer: Ken



5.6. Test Result and Data (1000MHz~6000MHz)

Power	: AC 230V	Pol/Phase	: VERTICAL
Test Mode 1	: LINK LAN (1000Mbps) + R/W	Temperature	: 24 °C
Test Date	: 2012/11/30	Humidity	: 60 %

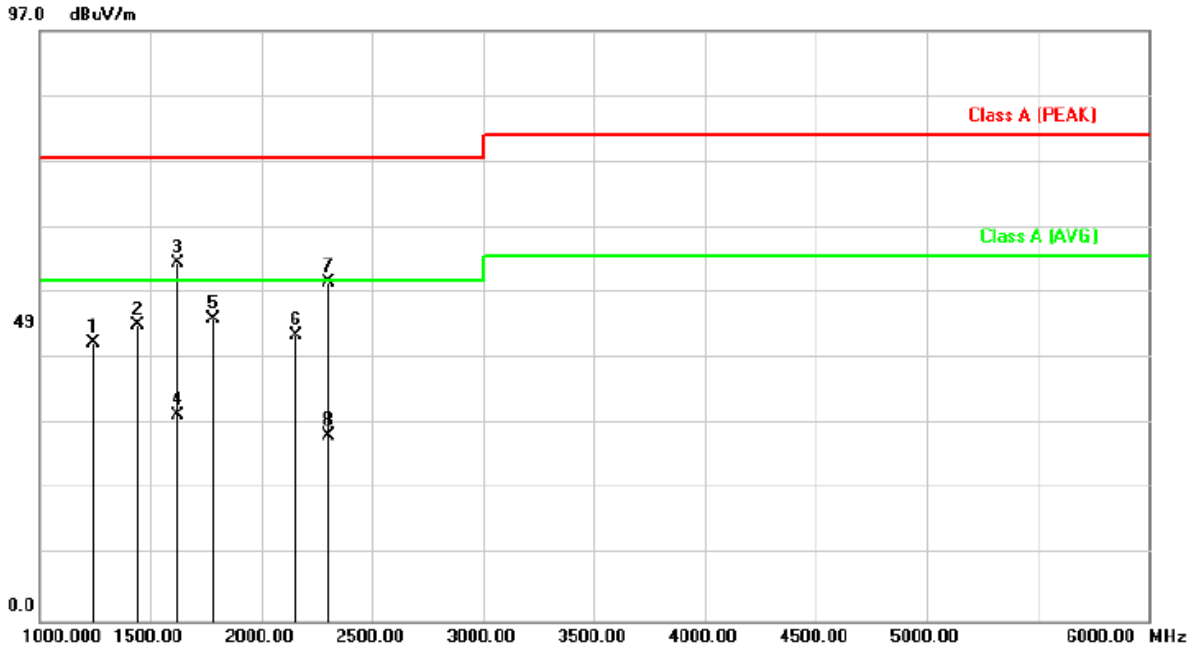

No.	Frequency (MHz)	Factor (dB/m)	Reading (dBuV)	Level (dBuV/m)	Limit (dBuV/m)	Margin (dB)	Detector	Height (cm)	Azimuth (°)	P/F
1	1245.000	-7.92	53.71	45.79	76.00	-30.21	peak	400	0	P
2	1440.000	-6.78	55.32	48.54	76.00	-27.46	peak	400	0	P
3	1620.000	-5.67	64.57	58.90	76.00	-17.10	peak	100	55	P
4	1620.000	-5.67	39.62	33.95	56.00	-22.05	AVG	100	55	P
5	1785.000	-4.65	54.28	49.63	76.00	-26.37	peak	400	0	P
6	2155.000	-2.78	49.78	47.00	76.00	-29.00	peak	400	0	P
7	2300.000	-2.29	57.83	55.54	76.00	-20.46	peak	100	155	P
8	2300.000	-2.29	32.63	30.34	56.00	-25.66	AVG	100	155	P

Note: Level = Reading + Factor
 Margin = Level – Limit



Power	: AC 230V	Pol/Phase	: HORIZONTAL
Test Mode 1	: LINK LAN (1000Mbps) + R/W	Temperature	: 24 °C
Test Date	: 2012/11/30	Humidity	: 60 %

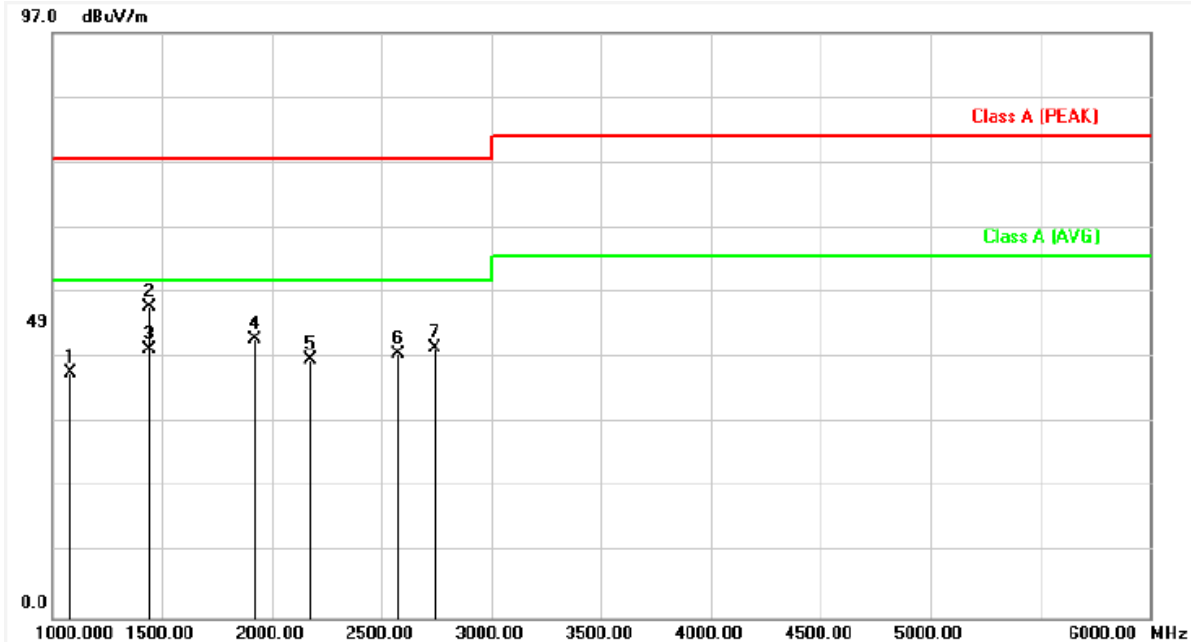

No.	Frequency (MHz)	Factor (dB/m)	Reading (dBuV)	Level (dBuV/m)	Limit (dBuV/m)	Margin (dB)	Detector	Height (cm)	Azimuth (°)	P/F
1	1080.000	-8.89	49.43	40.54	76.00	-35.46	peak	100	0	P
2	1440.000	-6.78	58.42	51.64	76.00	-24.36	peak	100	139	P
3	1440.000	-6.78	51.28	44.50	56.00	-11.50	AVG	100	139	P
4	1925.000	-3.78	50.04	46.26	76.00	-29.74	peak	100	0	P
5	2175.000	-2.71	45.47	42.76	76.00	-33.24	peak	100	0	P
6	2575.000	-1.24	45.13	43.89	76.00	-32.11	peak	100	0	P
7	2745.000	-0.38	45.08	44.70	76.00	-31.30	peak	100	0	P

Note: Level = Reading + Factor
Margin = Level – Limit

Test engineer: Smith



5.7. Test Photographs (30MHz-1000MHz)

Front View



Rear View

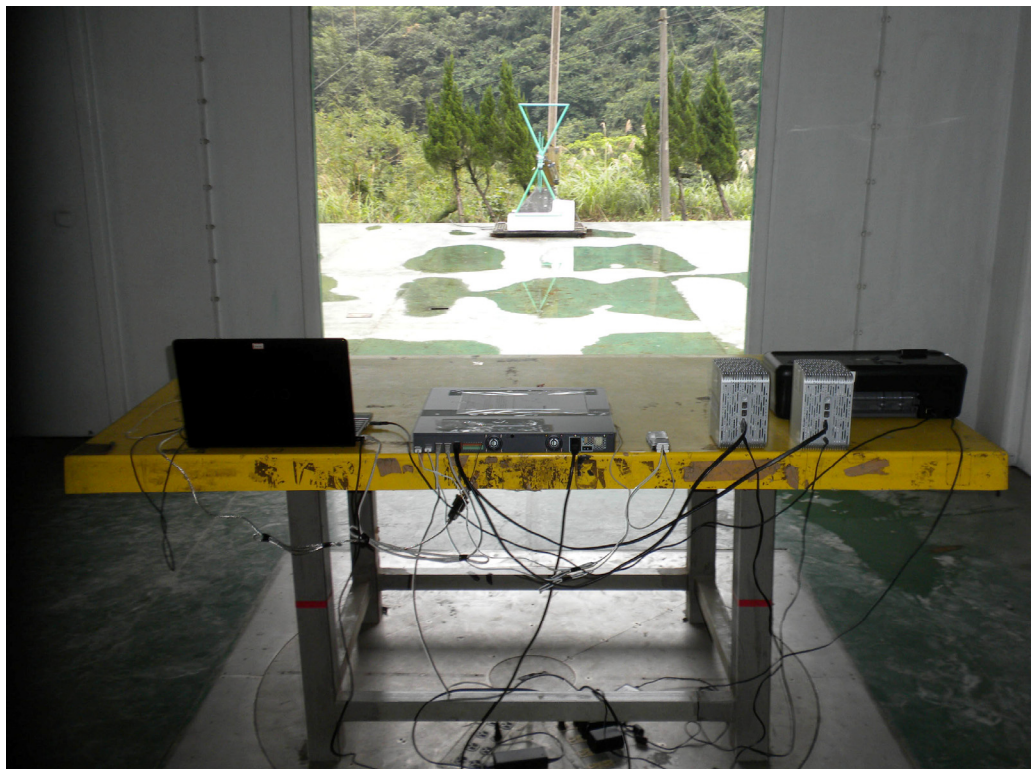



5.8. Test Photographs (1000MHz~6000MHz)

Front View

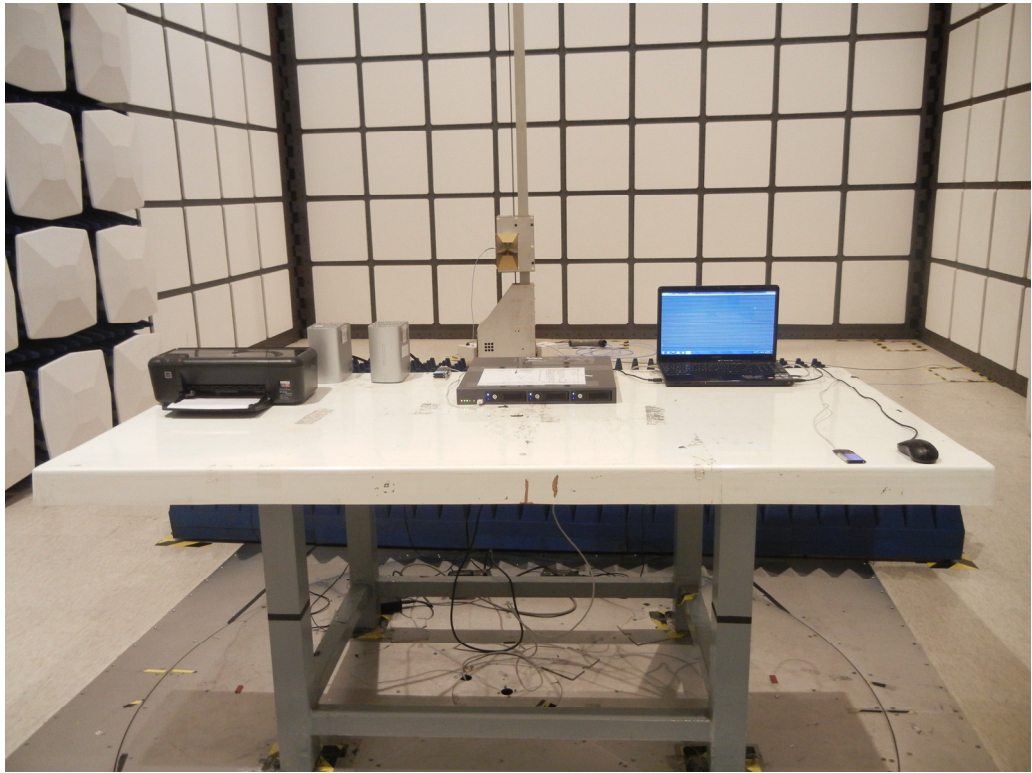

Rear View

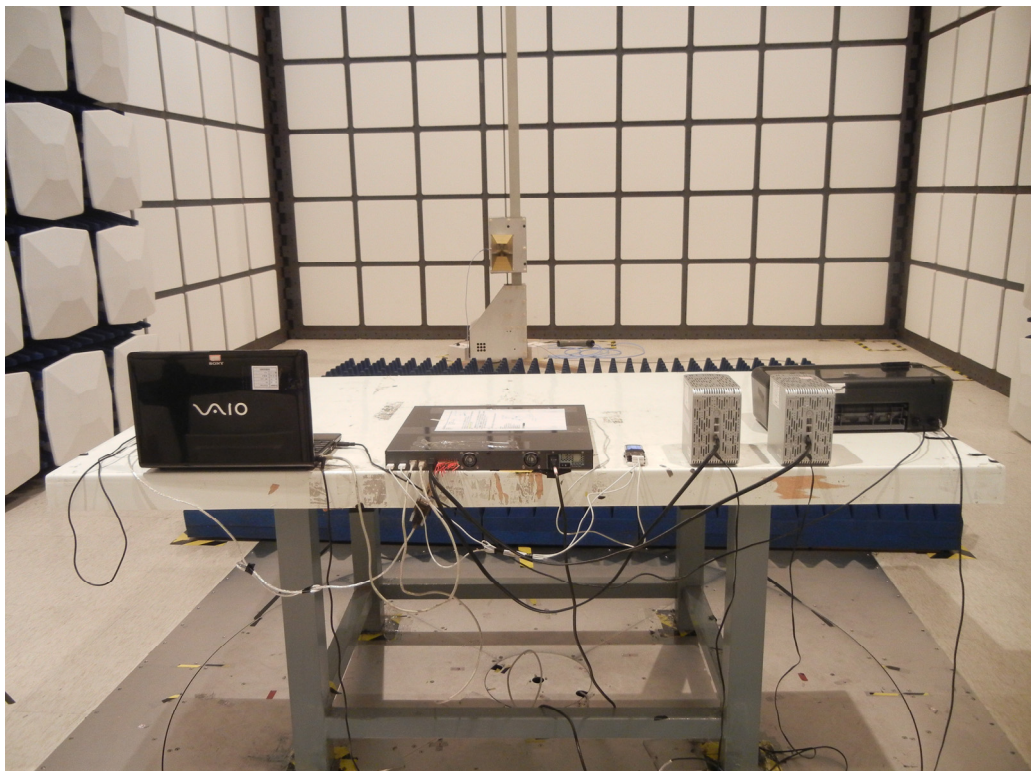



6. Harmonics Test

6.1. Limits of Harmonics Current Measurement

Limits for Class A equipment		Limits for Class D equipment		
Harmonics Order n	Max. Permissible harmonics current A	Harmonics Order n	Max. Permissible harmonics current per watt mA/W	Max. Permissible harmonics current A
Odd harmonics		Odd Harmonics only		
3	2.30	3	3.4	2.30
5	1.14	5	1.9	1.14
7	0.77	7	1.0	0.77
9	0.40	9	0.5	0.40
11	0.33	11	0.35	0.33
13	0.21	13	0.30	0.21
15<=n<=39	0.15 x 15/n	15<=n<=39	3.85/n	0.15 x 15/n
Even harmonics				
2	1.08			
4	0.43			
6	0.30			
8<=n<=40	0.23 x 8/n			

NOTE:

1. Class A and Class D are classified according to item section 5 of EN 61000-3-2 : 2006/A1:2009/A2:2009.
2. According go section 7 of EN 61000-3-2 : 2006/A1:2009/A2:2009, the above limits for all equipment except for lighting equipment are for all applications having an active input power > 75 W and no limits apply for equipment with an active input power up to and including 75 W.

6.2. Test Result and Data

The actual power output of EUT is less than 75W, so it is unable to quote from EN 61000-3-2.



7. Voltage Fluctuations Test

7.1. Test Procedure

The equipment shall be tested under the conditions of **Clause 5**.

The total impedance of the test circuit, excluding the appliance under test, but including the internal impedance of the supply source, shall be equal to the reference impedance. The stability and tolerance of the reference impedance shall be adequate to ensure that the overall accuracy of $\pm 8\%$ is achieved during the whole assessment procedure.

7.2. Measurement Equipment

Instrument	Manufacturer	Model No.	Serial No.	Calibration Date	Valid Date
Power & Harmonics Analyzer	TTI	HA1600	198226	2012/01/16	2013/01/15



7.4. Test Photographs





8. Electrostatic Discharge Immunity Test

8.1. Test Procedure

- a. In the case of air discharge testing the climatic conditions shall be within the following ranges:
 - ambient temperature: 15°C to 35°C;
 - relative humidity : 30% to 60%;
 - atmospheric pressure : 86 KPa (860 mbar) to 106 KPa (1060 mbar).
- b. Test programs and software shall be chosen so as to exercise all normal modes of operation of the EUT. The use of special exercising software is encouraged, but permitted only where it can be shown that the EUT is being comprehensively exercised.
- c. The test voltage shall be increased from the minimum to the selected test severity level, in order to determine any threshold of failure. The final severity level should not exceed the product specification value in order to avoid damage to the equipment.
- d. The test shall be performed with both air discharge and contact discharge. On reselected points at least 10 single discharges (in the most sensitive polarity) shall be applied on air discharge. On reselected points at least 25 single discharges (in the most sensitive polarity) shall be applied on contact discharge.
- e. For the time interval between successive single discharges an initial value of one second is recommended. Longer intervals may be necessary to determine whether a system failure has occurred.
- f. In the case of contact discharges, the tip of the discharge electrode shall touch the EUT before the discharge switch is operated.
- g. In the case of painted surface covering a conducting substrate, the following procedure shall be adopted :
 - If the coating is not declared to be an insulating coating by the equipment manufacturer, then the pointed tip of the generator shall penetrate the coating so as to make contact with the conducting substrate.
 - Coating declared as insulating by the manufacturer shall only be submitted to the air discharge.
 - The contact discharge test shall not be applied to such surfaces.
- h. In the case of air discharges, the round discharge tip of the discharge electrode shall be approached as fast as possible (without causing mechanical damage) to touch the EUT . After each discharge, the ESD generator (discharge electrode) shall be removed from the EUT. The generator is then retriggered for a new single discharge. This procedure shall be repeated until the discharges are completed. In the case of an air discharge test, the discharge switch, which is used for contact discharge, shall be closed.

8.2. Test Setup for Tests Performed in Laboratory

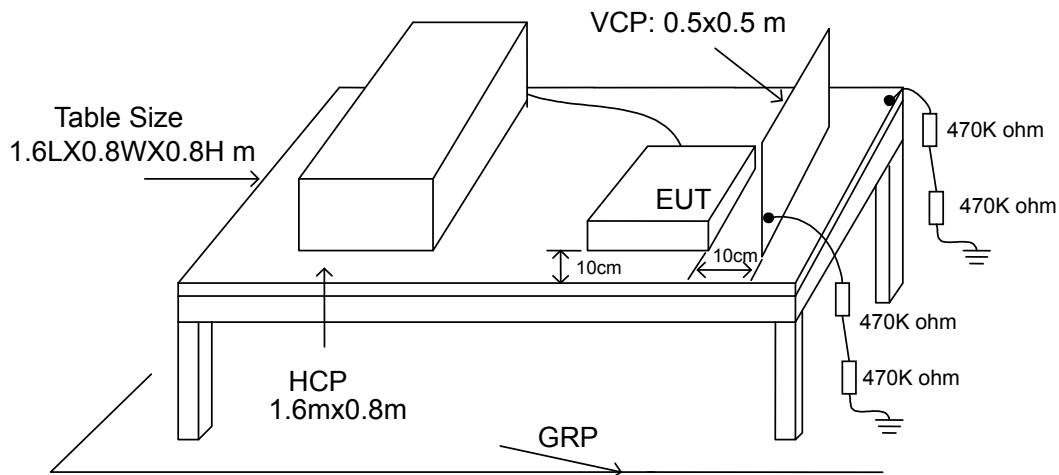

The test setup consists of the test generator, EUT and auxiliary instrumentation necessary to perform DIRECT and INDIRECT application of discharges to the EUT as applicable, in the follow manner :

- a. Contact Discharge to the conductive surfaces and to coupling plane;
- b. Air Discharge at insulating surfaces.

The preferred test method is that of type tests performed in laboratories and the only accepted method of demonstrating conformance with this standard. The EUT was arranged as closely as possible to arrangement in final installed conditions.

A ground reference plane was provided on the floor of the test site. It was a metallic sheet (copper or aluminum) of 0.25 mm, minimum thickness; other metallic may be used but they shall have at least 0.65 mm thickness. In the CerpPASS Technology Corp., we provided 1 mm thickness stainless steel ground reference plane. The minimum size of the ground reference plane is 2.5 m x 2.5 m, the exact size depending on the dimensions of the EUT. It was connected to the protective grounding system.

The EUT was arranged and connected according to its functional requirements. A distance of 1m minimum was provided between the EUT and the wall of the lab. and any other metallic structure. In cases where this length exceeds the length necessary to apply the discharges to the selected points, the excess length shall, where possible, be placed non-inductively off the ground reference plane and shall not come closer than 0.2m to other conductive parts in the test setup.

Where the EUT is installed on a metal table, the table was connected to the reference plane via a cable with a 470k ohm resistor located at each end, to prevent a build-up of charge. The test setup was consist a wooden table, 0.8m high, standing on the ground reference plane. A HCP, 1.6 m x 0.8 m, was placed on the table. The EUT and cables was isolated from the HCP by an insulating support 0.5 mm thick. The VCP size, 0.5 m x 0.5 m.



8.3. Test Severity Levels

Contact Discharge		Air Discharge	
Level	Test Voltage (KV) of Contact discharge	Level	Test Voltage (KV) of Air Discharge
1	±2	1	±2
2	±4	2	±4
3	±6	3	±8
4	±8	4	±15
X	Specified	X	Specified

Remark: "X" is an open level.

8.4. Measurement Equipment

Instrument	Manufacturer	Model No.	Serial No.	Calibration Date	Valid Date
ESD SIMULATOR	Schaffner	NSG438	878	2012/03/22	2013/03/21



8.6. Test Photographs





9. Radio Frequency electromagnetic field immunity test

9.1. Test Procedure

- The equipment to be tested is placed in the center of the enclosure on a wooden table. The equipment is then connected to power and signal leads according to pertinent installation instructions.
- The antenna which is enabling the complete frequency range of 80-1000 MHz is placed 3m away from the equipment. The required field strength is determined by placing the field strength meter(s) on top of or directly alongside the equipment under test and monitoring the field strength meter via a remote field strength indicator outside the enclosure while adjusting the continuous-wave to the applicable antennae.
- The test is normally performed with the antenna facing the most sensitive side of the EUT. The polarization of the field generated by the bucolical antenna necessitates testing each position twice, once with the antenna positioned vertically and again with the antenna positioned horizontally. The circular polarization of the field from the log-spiral antenna makes a change of position of the antenna unnecessary.
- At each of the above conditions, the frequency range is swept 80-1000 MHz, pausing to adjust the R.F. signal level or to switch oscillators and antenna. The rate of sweep is in the order of 1.5×10^{-3} decades/s. The sensitive frequencies or frequencies of dominant interest may be discretely analyzed.

9.2. Test Severity Levels

Frequency Band : 80-1000 MHz	
Level	Test field strength (V/m)
1	1
2	3
3	10
X	Specified
Remark: "X" is an open class.	

9.3. Measurement Equipment

Instrument	Manufacturer	Model No.	Serial No.	Calibration Date	Valid Date
Amplifiers 80-1000MHz/100W	SCHAFFNER	CBA9413B	43510	N/A	N/A
Amplifiers 80-3000MHz/20W	SCHAFFNER	CBA9428	43515	N/A	N/A
Antenna	SCHAFFNER	CBL6141A	4257	N/A	N/A
Power Meter	Boonton	4231A-01	115902	2012/09/26	2013/09/25
Field Probe	HOLADAY	HI-6005	00035824	2012/09/20	2013/09/19
Signal Generator	HP	8648B	3629U00612	2012/09/26	2013/09/25
Power Sensor	Boonton	51011-EMC	33312	2012/09/26	2013/09/25



9.5. Test Photographs

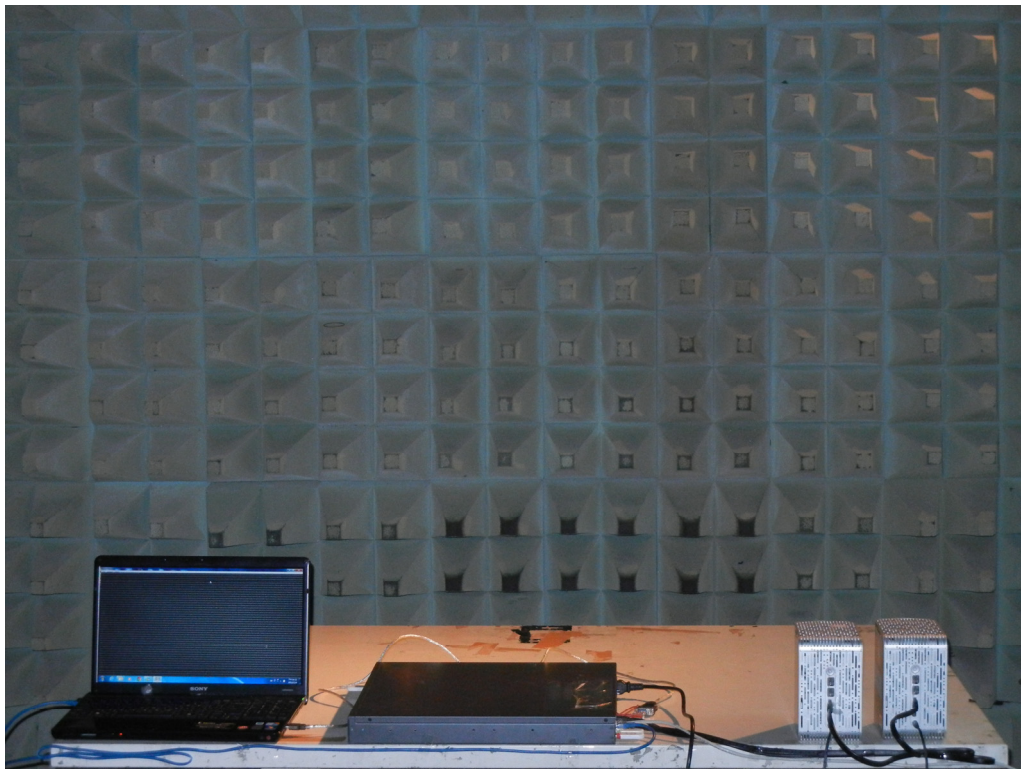
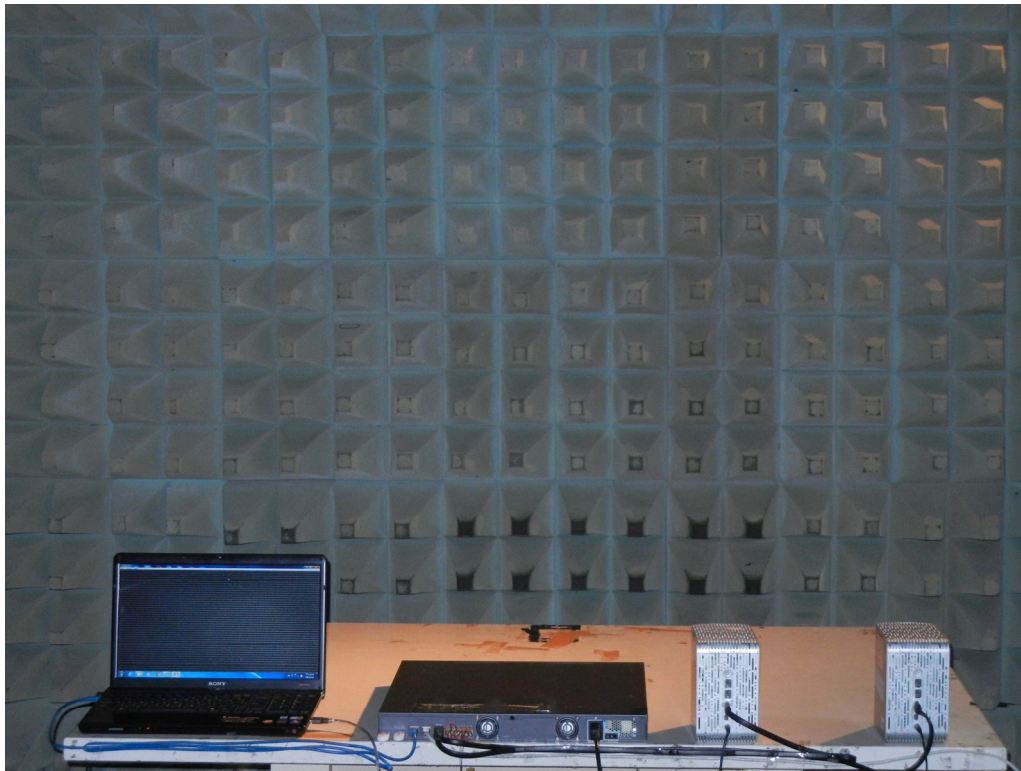

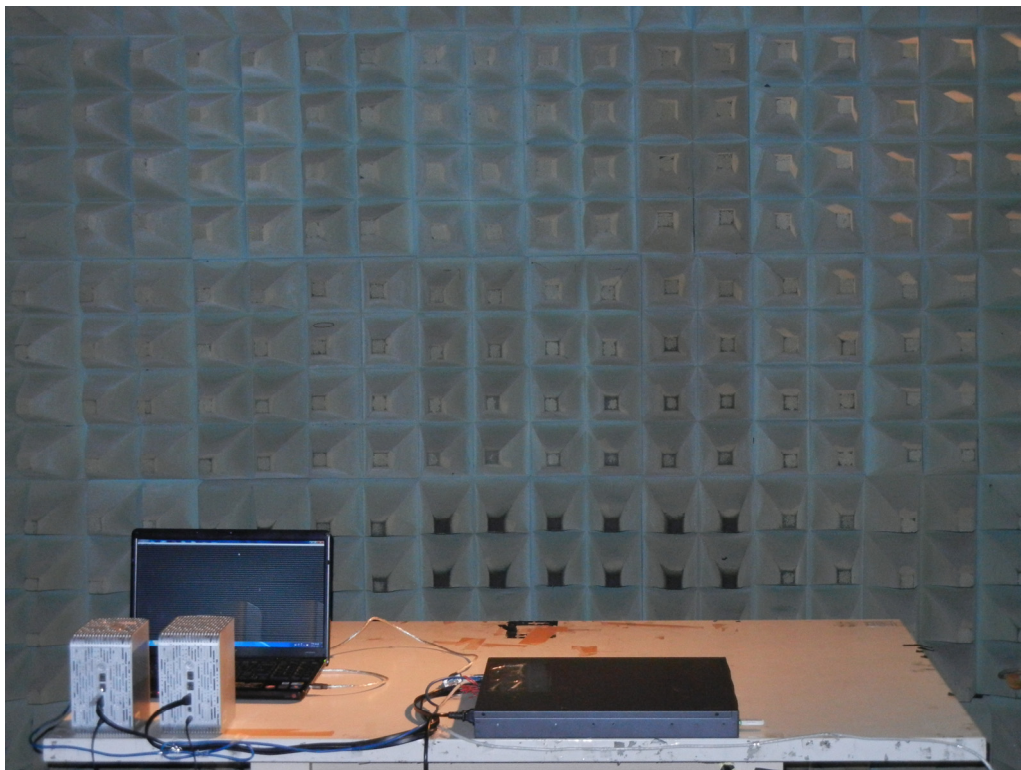
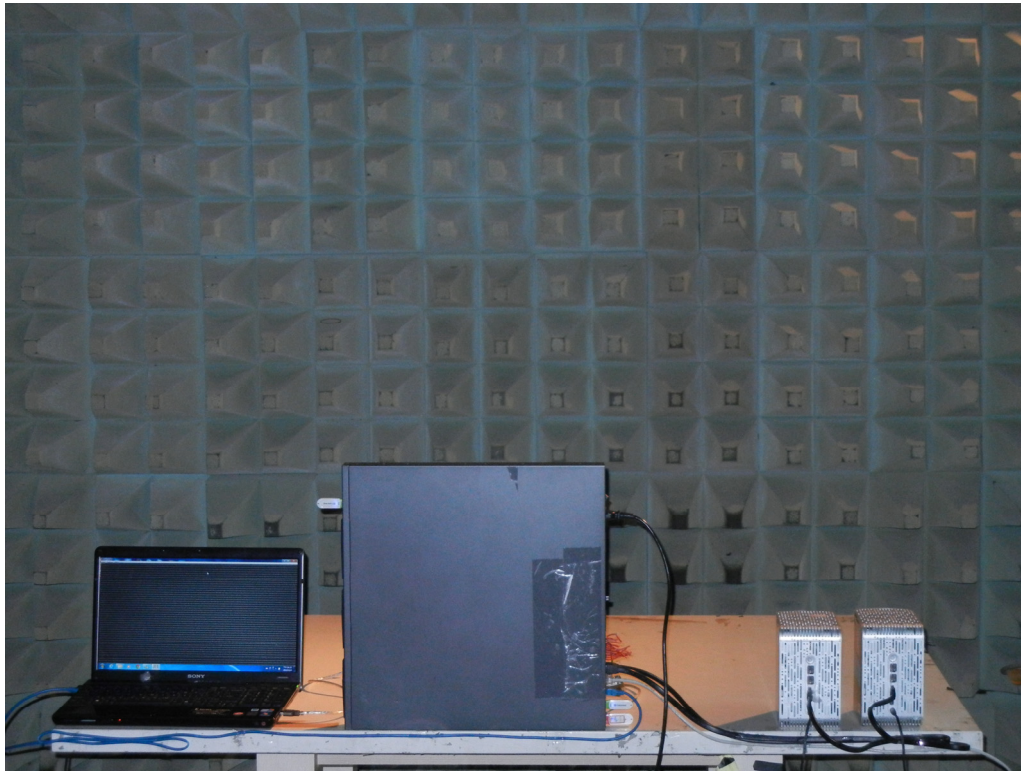

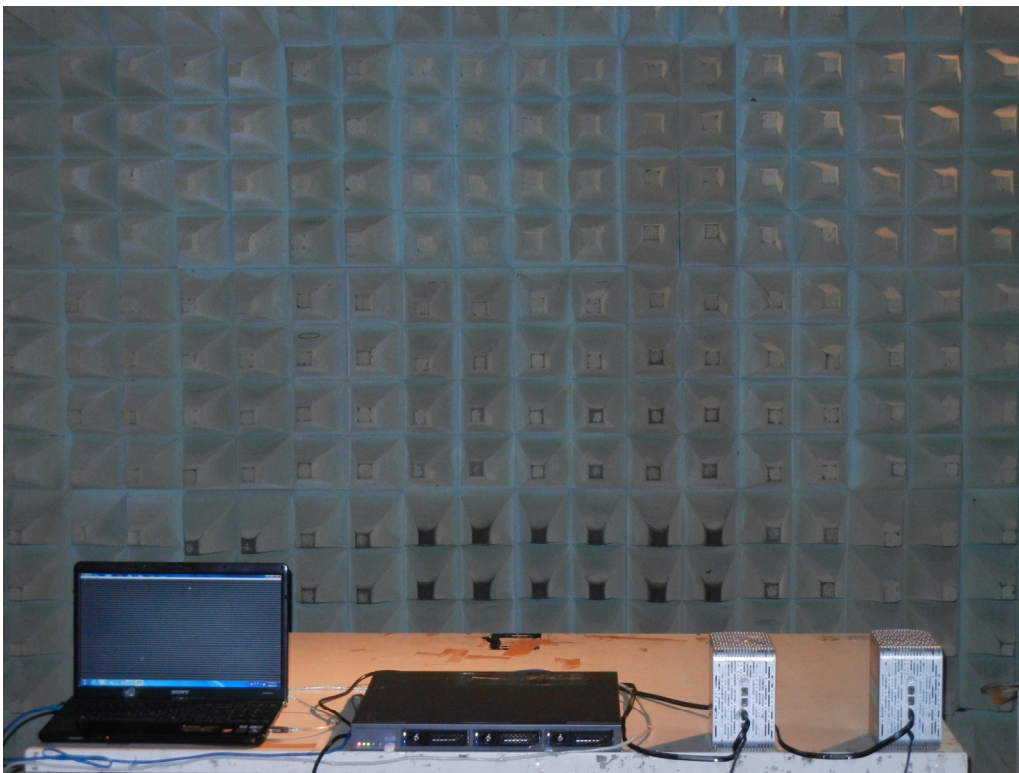
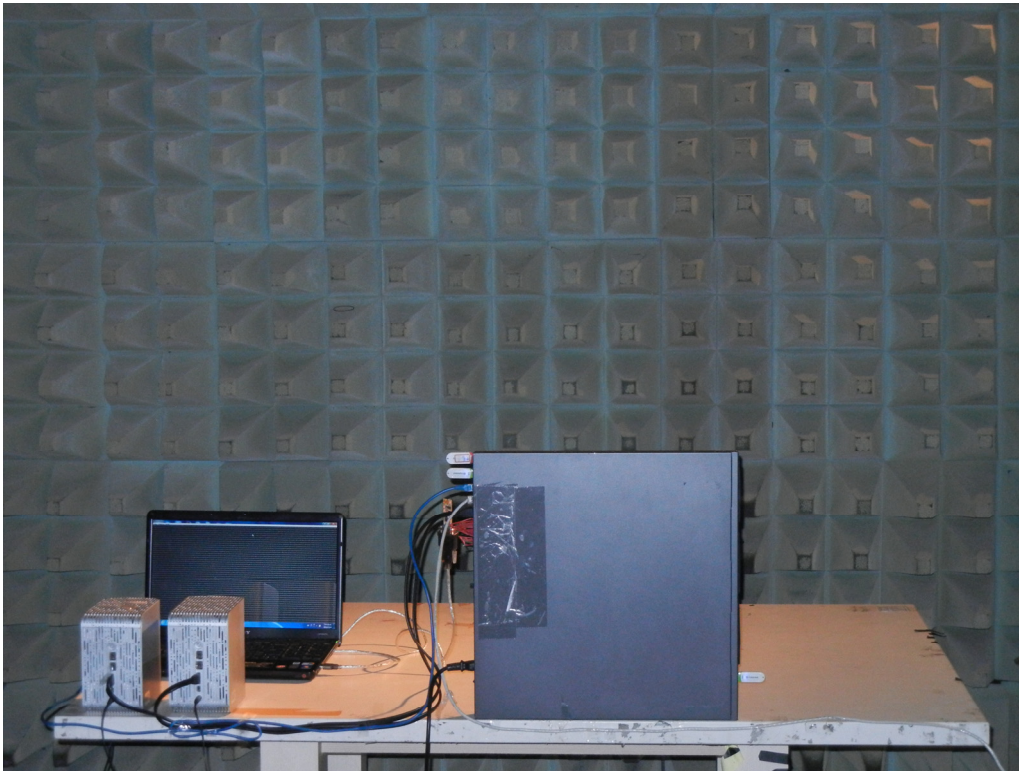



10. Electrical Fast Transient/ Burst Immunity Test

10.1. Test Procedure

- a. In order to minimize the effect of environmental parameters on test results, the climatic conditions when test is carrying out shall comply with the following requirements:
 - ambient temperature: 15°C to 35°C;
 - relative humidity : 45% to 75%;
 - Atmospheric pressure: 86 Kpa (860 mbar) to 106 Kpa (1060 mbar).
- b. In order to minimize the effect of environmental parameters on test results, the electromagnetic environment of the laboratory shall not influence the test results.
- c. The variety and diversity of equipment and systems to be tested make it difficult to establish general criteria for the evaluation of the effects of fast transients/bursts on equipment and systems.
- d. Test on Power Line:
 - The EFT/B-generator was located on the GRP.. The length from the EFT/B-generator to the EUT is not exceeding 1 m.
 - The EFT/B-generator provides the ability to apply the test voltage in a non-symmetrical condition to the power supply input terminals of the EUT.
- e. Test on Communication Lines
 - The coupling clamp is composed of a clamp unit for housing the cable (length more than 3 m), and was placed on the GRP.
 - The coupling clamp provides the ability of coupling the fast transient/bursts to the cable under test.
- f. The test results may be classified on the basic of the operating conditions and the functional specification of the equipment under test, according to the following performance criteria :
 - Normal performance within the specification limits.
 - Temporary degradation or loss of function or performance which is self-recoverable.
 - Temporary degradation or loss of function or performance which requires operator intervention or system reset.
 - Degradation or loss of function which is not recoverable due to damage of equipment (components).

10.2. Test Severity Levels

The following test severity levels are recommended for the fast transient/burst test :

Open circuit output test voltage $\pm 10\%$		
Level	On Power Supply	On I/O signal, data and control line
1	0.5 KV	0.25 KV
2	1.0 KV	0.50 KV
3	2.0 KV	1.00 KV
4	4.0 KV	2.00 KV
X	Specified	Specified

Remark : “ X ” is an open level. The level is subject to negotiation between the user and manufacturer or is specified by the manufacturer.

10.3. Measurement Equipment

Instrument	Manufacturer	Model No.	Serial No.	Calibration Date	Valid Date
TESQ NSG3060	TESQ	NSG3060	1385	2012/07/03	2013/07/02



10.4. Test Result and Data

Final Test Result : **PASS**
 Pass performance criteria : A
 Required performance criteria : B
 Basic Standard : IEC 61000-4-4
 Product Standard : EN 55024
 Test Voltage : On Signal Port -- ± 0.5 KV
 Temperature : 26 °C
 Relative Humidity : 54 %
 Atmospheric Pressure : 1011 hPa
 Test Date : 2012/11/30

Pulse : 5/50 ns		Repetition Rate:			
Burst : 15m/300ms		5 kHz below and equal 2.0Kv			
Test time : 1 min/each condition					
Voltage/ Mode/ Polarity/ Result/ Phase		0.5 kV		1.0 kV	
		+	-	+	-
Power Line	L	A	A	A	A
	N	A	A	A	A
	L-N	A	A	A	A
	PE	A	A	A	A
	L-PE	A	A	A	A
	N-PE	A	A	A	A
	L-N-PE	A	A	A	A
Signal Line	RJ45 LAN (10/100/1000Mbps)	A	A	---	---

Note: "A" Means the EUT function is normal working during the test.

Test engineer: EIA



10.5. Test Photographs





11. Surge Immunity Test

11.1. Test Procedure

- a. Climatic conditions
The climatic conditions shall comply with the following requirements :
 - ambient temperature : 15 °C to 35 °C
 - relative humidity : 10 % to 75 %
 - atmospheric pressure : 86 kPa to 106 kPa (860 mbar to 1060 mbar)
- b. Electromagnetic conditions
the electromagnetic environment of the laboratory shall not influence the test results.
- c. The test shall be performed according the test plan that shall specify the test set-up with
 - generator and other equipment utilized;
 - test level (voltage/current);
 - generator source impedance;
 - internal or external generator trigger;
 - number of tests : at least five positive and five negative at the selected points;
 - repetition rate : maximum 1/min.
 - inputs and outputs to be tested;
 - representative operating conditions of the EUT;
 - sequence of application of the surge to the circuit;
 - phase angle in the case of AC. power supply;
 - actual installation conditions, for example :
 - AC : neutral earthed,
 - DC : (+) or (-) earthed to simulated the actual earthing conditions.
- d. If not otherwise specified the surges have to be applied synchronized to the voltage phase at the zero-crossing and the peak value of the AC. voltage wave (positive and negative).
- e. The surges have to be applied line to line and line(s) and earth. When testing line to earth, the test voltage has to be applied successively between each of the lines and earth, if there is no other specification.
- f. The test procedure shall also consider the non-linear current-voltage characteristics of the equipment under test. Therefore the test voltage has to be increased by steps up to the test level specified in the product standard or test plan.
- g. All lower levels including the selected test level shall be satisfied. For testing the secondary protection, the output voltage of the generator shall be increased up to the worst-case voltage breakdown level (let-through level) of the primary protection.
- h. If the actual operating signal sources are not available, that may be simulated. Under no circumstances may the test level exceed the product specification. The test shall be carried out according to a test plan.
- i. To find all critical points of the duty cycle of the equipment, a sufficient number of positive and negative test pulses shall be applied. For acceptance test previously unstressed equipment shall be used to the protection devices shall be replaced.

11.2. Test Severity Level

Level	Open-circuit test voltage, ± 10%, KV
1	0.5
2	1.0
3	2.0
4	4.0
X	Specified
NOTE: "X" is an open class. This level can be specified in the product specification.	



11.1. Measurement Equipment

Instrument	Manufacturer	Model No.	Serial No.	Calibration Date	Valid Date
TESQ NSG3060	TESQ	NSG3060	1385	2012/07/03	2013/07/02

11.2. Test Result and Data

Final Test Result : **PASS**
 Pass performance criteria : A
 Required performance criteria : B
 Basic Standard : IEC 61000-4-5
 Product Standard : EN 55024
 Test Voltage : AC Power Port -- ± 0.5 kV, ± 1.0 kV, ± 2.0 kV
 Temperature : 26 °C
 Relative Humidity : 54%
 Atmospheric Pressure : 1011 hPa
 Test Date : 2012/11/30

Power Port

Waveform : 1.2/50µs(8/20µs)		Repetition rate : 60 sec		Time : 5 time/each condition		
Phase Voltage / Mode / Polarity / Result		0°	90°	180°	270°	
0.5 kV, 1.0kV	L-N	+	A	A	A	A
		-	A	A	A	A
2.0 kV	L-PE, N-PE	+	A	A	A	A
		-	A	A	A	A

Signal Port

RJ45 The ports of EUT which according to the manufacturer’s specification can’t connect directly to outdoor cable.

Note: “A” means the EUT function is normal working during the test.

Test engineer: EIA



11.3. Test Photographs





12. Conduction Disturbances induced by Radio-Frequency Fields

12.1. Test Procedure

- a. The EUT shall be operated within its intended climatic conditions. The temperature and relative humidity should be recorded.
- b. This test method test can be performed without using a sell shielded enclosure. This is because the disturbance levels applied and the geometry of the setups are not likely to radiated a high amount of energy, especially at the lower frequencies. If under certain circumstances the radiated energy is too high, a shielded enclosure has to be used.
- c. The test shall be performed with the test generator connected to each of the coupling and decoupling devices in turn while the other non-excited RF-input ports of the coupling devices are terminated by a 50 ohm load resistor.
- d. The frequency range is swept from 150 KHz to 80 MHz, using the signal levels established during the setting process, and with the disturbance signal 80% amplitude modulated with a 1KHz sign wave, pausing to adjust the RF-signal level or to switch coupling devices as necessary. The rate of sweep shall no exceed 1.5×10^{-3} decades/s. Where the frequency is swept incrementally, the step size shall no exceed 1% of the start and thereafter 1% of the preceding frequency value.
- e. The dwell time at each frequency shall not be less than the time necessary for the EUT to be exercised, and able to respond. Sensitive frequencies e.g. clock frequency (ies) and harmonics or frequencies of dominant interest shall be analyzed separately.
- f. An alternative test procedure may be adopted, wherein the frequency range is swept incrementally, with a step size not exceeding 4% of the start ad thereafter 4% of the preceding frequency value. The test level should be at least twice the value of the specified test level.
- g. In cases of dispute, the test procedure using a step size not exceeding 1% of the start and thereafter 1% of preceding frequency value shall take precedence.
- h. Attempts should be made to fully exercise the EUT during testing, and to fully interrogate all exercise modes selected for susceptibility.
- i. The use of special exercising programs is recommended.
- j. Testing shall be performed according to a Test Plan, which shall be included in the test report.
- k. It may be necessary to carry out some investigatory testing in order to establish some aspects of the test plan.

12.2. Test Severity Levels

Level	Voltage Level (EMF)
1	1 V
2	3 V
3	10 V
x	Specified
NOTE - x is an open class. This level can be specified in the product specification.	

12.3. Measurement Equipment

Instrument	Manufacturer	Model No.	Serial No.	Calibration Date	Valid Date
CS GENERATOR	Schaffner	NSG 2070	1059	2012/09/26	2013/09/25
CDN (M2+M3)	Schaffner	M016	20056	2012/09/26	2013/09/25
CDN	Schaffner	T400	19818	2012/09/26	2013/09/25
EM-CLAMP	Schaffner	KEMZ 801	19793	2012/09/26	2013/09/25



12.5. Test Photographs



13. Power Frequency Magnetic Field Immunity Test

13.1. Test Setup

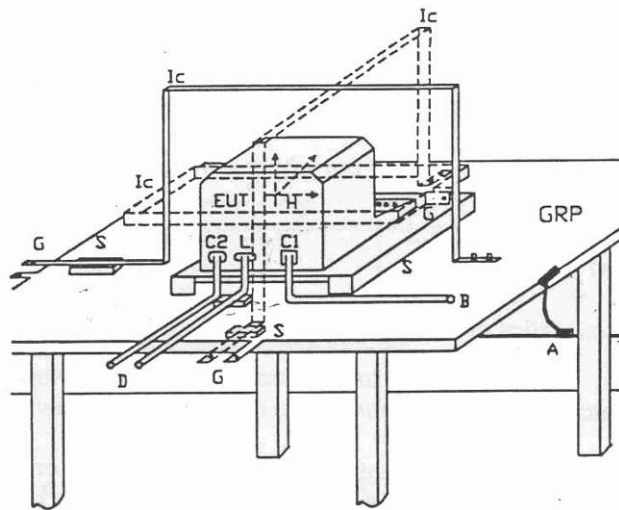

- GPR : Ground plane
- A : Safety earth
- S : Insulating support
- EUT : Equipment under test
- Lc : Induction coil
- E : Earth terminal
- C1 : Power supply circuit
- C2 : Signal circuit
- L : Communication line
- B : To power supply source
- D : To signal source, simulator
- G : To the test generator

13.2. Test Severity Levels

Level	Magnetic field strength (A/m)
1	1
2	3
3	10
4	30
5	100
X ¹⁾	special

NOTE 1 "X" is an open level. This level can be given in the product specification.

13.3. Measurement Equipment

Instrument	Manufacturer	Model No.	Serial No.	Calibration Date	Valid Date
MAGNETIC FIELD GENERATOR	KeyTek	F-1000-4-8-G-125A	N/A	2012/09/26	2013/09/25



13.4. Test Result and Data

Final Test Result : **PASS**
 Pass performance criteria : A
 Required performance criteria : A
 Basic Standard : IEC 61000-4-8
 Product Standard : EN 55024
 Temperature : 24°C
 Relative Humidity : 54 %
 Atmospheric Pressure : 1011 hPa
 Test Date : 2012/11/30

Power Frequency Magnetic Field : <u>50</u> Hz, <u>1</u> A/m		
Coil Orientation	Testing duration	Results
X-axis	1.0 Min	A
Y-axis	1.0 Min	A
Z-axis	1.0 Min	A

Note: "A" Mean the EUT function is normal working during the test.

Test engineer: EIS



13.5. Test Photographs





14. Voltage Dips and Voltage Interruptions Immunity Test Setup

14.1. Test Conditions

1. Source voltage and frequency : 100/230/240V / 50Hz, Single phase.
2. Test of interval : 10 sec.
3. Level and duration : Sequence of 3 dips/interrupts.
4. Voltage rise (and fall) time : 1 ~ 5 μ s.
5. Test severity :

Voltage dips and Interrupt reduction (%)	Test Duration (period)
>95%	250
30%	25
>95%	0.5

14.1. Measurement Equipment

Instrument	Manufacturer	Model No.	Serial No.	Calibration Date	Valid Date
TESQ NSG3060	TESQ	NSG3060	1385	2012/07/03	2013/07/02



14.2. Test Result and Data

Final Test Result : **PASS**
 Pass performance Criteria : C for voltage interruption, A for voltage dips
 Required performance Criteria : C for voltage interruption, B/C for voltage dips
 Basic Standard : IEC 61000-4-11
 Product Standard : EN 55024
 Temperature : 23°C
 Relative Humidity : 55 %
 Atmospheric Pressure : 1011 hPa
 Test Date : 2012/11/30

Voltage(UT): AC <u>100/230/240</u> V <u>50</u> Hz Interval(s) : <u>10s</u> Times : <u>3</u>				
Test mode	Test level reduction %	Durations (period)	Phase / Result	
			0°	180°
Voltage interruptions	>95%	250	C	C
Voltage dips	30%	25	A	A
	>95%	0.5	A	A

Note: "A" means the EUT function is normal working during the test.

"C" means the power of EUT is off during the test, and it can be recovered by manual resetting.

Test engineer: EIA



14.3. Test Photographs





Appendix A. Photographs of EUT







