

# *Certificate of Compliance*

**with**

## **European Low Voltage Directive**

**No.**

*Type of equipment:*

*Certificate holder:*

*Type designation:*

*Technical data:*

A sample of the equipment has been tested for CE-marking according to the EC Low Voltage Directive,

Standard used for showing compliance with the essential requirements of the directive:

*Standard(s):*

*Test report(s):*

*Issued by:*

*Date(s):*

Cerpass

The referred test report(s) show that the product fulfills the requirements in the EC Low Voltage Directive for CE marking. On this basis, together with the manufacturer's own documented production control, the manufacturer (or his European authorized representative) can in his EC Declaration of Conformity verify compliance with the EC Low Voltage Directive.

**CE**



**Engineering Department**



<b>TEST REPORT</b> <b>IEC 60950-1</b> <b>Information technology equipment – Safety –</b> <b>Part 1: General requirements</b>	
<b>Report Reference No.</b> .....	T1211068-319
Tested by (printed name and signature) .....	Nick Huang <i>Nick Huang</i>
Approved by (printed name and signature) .....	Miller Chang <i>Miller Chang</i>
Date of issue.....	November 06, 2012
<b>Testing Laboratory Name</b> .....	CERPASS TECHNOLOGY CORP.
Address .....	9F, NO. 200, GANGCIAN RD., NEIHU DISTRICT, TAIPEI CITY 114, TAIWAN
<b>Applicant's name</b> .....	VIVOTEK INC.
Address .....	6F, NO 192, LIEN-CHENG RD., CHUNG-HO, NEW TAIPEI CITY 235, TAIWAN, R.O.C.
<b>Test specification:</b>	
Standard .....	IEC 60950-1:2005 (2nd Edition); Am 1:2009 and/or EN 60950-1:2006 + A11:2009 + A1:2010 + A12:2011
Test procedure .....	Service of CE Marking in LVD
Non-standard test method.....	N/A
<b>Test item description</b> .....	Network Video Recorder
Trade Mark .....	
Manufacturer .....	Same as applicant.
Model/Type reference.....	ND8401
Ratings .....	100-240Vac, 3A, 50-60Hz



<b>Particulars: test item vs. test requirements</b>	
Equipment mobility.....	Movable
Connection to the mains .....	Pluggable equipment
Operating condition.....	Continuous
Access location .....	Operator accessible
Over voltage category (OVC) .....	OVCII
Mains supply tolerance (%) or absolute mains supply values .....	-10%, +10%
Tested for IT power systems .....	YES
IT testing, phase-phase voltage (V) .....	230Vac for Norway
Class of equipment .....	Class I
Considered current rating (A) .....	16 A
Pollution degree (PD) .....	PD 2
IP protection class .....	IPX0
Altitude during operation (m) .....	< 2000 m
Altitude of test laboratory (m) .....	< 2000 m
Mass of equipment (kg) .....	5.3kg
<b>Possible test case verdicts:</b>	
- test case does not apply to the test object .....	N/A
- test object does meet the requirement.....	P (Pass)
- test object does not meet the requirement.....	F (Fail)
<b>Testing</b>	
Date of receipt of test item .....	November 19, 2012
Date(s) of performance of tests .....	November 19, 2012 – November 05, 2012
<b>General remarks:</b>	
The test results presented in this report relate only to the object tested.	
This report shall not be reproduced, except in full, without the written approval of the Issuing testing laboratory.	
"(see Enclosure #)" refers to additional information appended to the report.	
"(see appended table)" refers to a table appended to the report.	
Throughout this report a point is used as the decimal separator.	
<b>Factor(ies):</b>	
VIVOTEK INC. 5F, NO.168, LIEN-CHENG RD., CHUNG-HO , NEW TAIPEI CITY, 235, TAIWAN, R.O.C.	



**General product information:**

This equipment, model ND8401 is a class I Network Video Recorder which is intended to be used as information technology equipment.

**Other comments:**

The maximum operational ambient temperature as specified by the manufacturer is 40°C.

The label drawing is a draft of an artwork for marking plates pending approval by National Certification Bodies and it shall be affixed to products prior to such an approval.

**Copy of marking plate:**

(Representative)

The marking plate artwork is enclosed in a rectangular border. On the left side, the text reads: "Network Video Recorder" in a large, bold font, followed by "Model No:ND8401", "Input:100-240VAC,3A 50-60Hz", and "MAC:002D1XXXXXXXX" twice, each accompanied by a barcode. On the right side, there are several certification logos: the Vivotek logo (a camera icon with the word "VIVOTEK"), the CE mark, the RoHS mark (a circular logo with a checkmark and the word "RoHS" and "XXXXX" below it), the FCC mark, the VCCI mark (a square logo with "VCCI" inside), and a crossed-out trash bin icon. At the bottom left, there is a paragraph of text: "This device complies with part 15 of the FCC Rules. Operation is subject to the following two conditions: (1) this device may not cause harmful interference, and (2) this device must accept any interference received, including interference that may cause undesired operation." At the bottom right, it says "Made in Taiwan".



IEC 60950-1			
Clause	Requirement + Test	Result - Remark	Verdict
<b>1</b>	<b>GENERAL</b>		<b>P</b>
<b>1.5</b>	<b>Components</b>		<b>P</b>
1.5.1	General	See below.	P
	Comply with IEC 60950-1 or relevant component standard	Components which were found to affect safety aspects comply with the requirements of this standard or with the safety aspects of the relevant IEC/EN component standards. See appended table 1.5.1.	P
1.5.2	Evaluation and testing of components	Components that are certified to IEC and /or national standards are used correctly within their ratings. Components not covered by IEC standards are tested under the conditions present in the equipment.	P
1.5.3	Thermal controls	No thermal control.	N/A
1.5.4	Transformers	Evaluated in approved building-in power supply unit.	N/A
1.5.5	Interconnecting cables	No such cables provided.	N/A
1.5.6	Capacitors bridging insulation	Evaluated in approved building-in power supply unit.	N/A
1.5.7	Resistors bridging insulation	Evaluated in approved building-in power supply unit.	N/A
1.5.7.1	Resistors bridging functional, basic or supplementary insulation	Same as above.	N/A
1.5.7.2	Resistors bridging double or reinforced insulation between a.c. mains and other circuits	Same as above.	N/A
1.5.7.3	Resistors bridging double or reinforced insulation between a.c. mains and antenna or coaxial cable	Same as above.	N/A
1.5.8	Components in equipment for IT power systems	Evaluated in approved building-in power supply unit.	N/A
1.5.9	Surge suppressors	No such suppressor.	N/A
1.5.9.1	General	Same as above.	N/A
1.5.9.2	Protection of VDRs	Same as above.	N/A
1.5.9.3	Bridging of functional insulation by a VDR	Same as above.	N/A
1.5.9.4	Bridging of basic insulation by a VDR	Same as above.	N/A



IEC 60950-1			
Clause	Requirement + Test	Result - Remark	Verdict
1.5.9.5	Bridging of supplementary, double or reinforced insulation by a VDR	Same as above.	N/A

1.6	Power interface		P
1.6.1	AC power distribution systems	TN power system. IT power system for Norway only.	P
1.6.2	Input current	Highest load according to 1.2.2.1 for this equipment is operated in link mode. (See appended table 1.6.2.)	P
1.6.3	Voltage limit of hand-held equipment	This appliance is not hand-held equipment.	N/A
1.6.4	Neutral conductor	Evaluated in approved building-in power supply unit.	N/A

1.7	Marking and instructions		P
1.7.1	Power rating and identification markings	See below.	P
1.7.1.1	Power rating marking	See below.	P
	Multiple mains supply connections.....:	Single mains supply.	N/A
	Rated voltage(s) or voltage range(s) (V) .....	AC 100-240Vac	P
	Symbol for nature of supply, for d.c. only .....	AC mains supply	N/A
	Rated frequency or rated frequency range (Hz) .....	50-60Hz	P
	Rated current (mA or A) .....	3A	P
1.7.1.2	Identification markings	See below.	P
	Manufacturer's name or trade-mark or identification mark .....		P
	Model identification or type reference .....	ND8401	P
	Symbol for Class II equipment only .....	Class I equipment.	N/A
	Other markings and symbols .....	Additional symbols or markings do not give rise to misunderstanding.	P
1.7.2	Safety instructions and marking	See below.	P
1.7.2.1	General	The user's manual contains information for operation, installation, servicing, transport, storage and technical data. The operation guide is provided to the user.	P



IEC 60950-1			
Clause	Requirement + Test	Result - Remark	Verdict
1.7.2.2	Disconnect devices	The installation instruction state that the socket-outlet shall be installed near the equipment and shall be easily accessible.	P
1.7.2.3	Overcurrent protective device	This equipment is not permanently connected equipment or pluggable equipment type B.	N/A
1.7.2.4	IT power distribution systems	It shall be evaluated when submitted for Norway national approval.	N/A
1.7.2.5	Operator access with a tool	No tool is required to gain access to operator access area.	N/A
1.7.2.6	Ozone	No ozone produces within this equipment.	N/A
1.7.3	Short duty cycles	Equipment is designed for continuous operation.	N/A
1.7.4	Supply voltage adjustment .....	No adjustment of supply voltage necessary.	N/A
	Methods and means of adjustment; reference to installation instructions .....	Same as above.	N/A
1.7.5	Power outlets on the equipment .....	No outlet provided.	N/A
1.7.6	Fuse identification (marking, special fusing characteristics, cross-reference) .....	Evaluated in approved building-in power supply unit.	N/A
1.7.7	Wiring terminals	See below.	P
1.7.7.1	Protective earthing and bonding terminals .....	Evaluated in approved building-in power supply unit.	N/A
1.7.7.2	Terminals for a.c. mains supply conductors	Same as above.	N/A
1.7.7.3	Terminals for d.c. mains supply conductors	AC mains supply only.	N/A
1.7.8	Controls and indicators	See below.	P
1.7.8.1	Identification, location and marking .....	The marking indication is located that indication of clearly.	P
1.7.8.2	Colours .....	No safety relevant control or indicator.	N/A
1.7.8.3	Symbols according to IEC 60417 .....	The switch is marked with symbol according to IEC 60417-1-5009	P



IEC 60950-1			
Clause	Requirement + Test	Result - Remark	Verdict
1.7.8.4	Markings using figures .....	No indicators for different positions of control.	N/A
1.7.9	Isolation of multiple power sources .....	Only one supply connection.	N/A
1.7.10	Thermostats and other regulating devices .....	No thermostats and similar regulating devices intended to be adjusted during installation or in normal use.	N/A
1.7.11	Durability	The label was subjected to the permanence of marking test. The label was rubbed with cloth soaked with water for 15 s and then again for 15 s with the cloth soaked with petroleum spirit. After this test there was no damage to the label. The marking on the label did not fade. There was neither curling nor lifting of the label edge.	P
1.7.12	Removable parts	No removable part provided.	N/A
1.7.13	Replaceable batteries .....	The R.T.C battery is exchangeable. Warning text provided in servicing manual.	P
	Language(s) .....	English.	—
1.7.14	Equipment for restricted access locations.....	Not restricted access location.	N/A
<b>2</b>	<b>PROTECTION FROM HAZARDS</b>		<b>P</b>
2.1	Protection from electric shock and energy hazards		<b>P</b>
2.1.1	Protection in operator access areas	See below.	<b>P</b>
2.1.1.1	Access to energized parts	See below.	<b>P</b>
	Test by inspection .....	No concerned parts were access.	<b>P</b>
	Test with test finger (Figure 2A) .....	Same as above.	<b>P</b>
	Test with test pin (Figure 2B) .....	Same as above.	<b>P</b>
	Test with test probe (Figure 2C) .....	No TNV circuits within this equipment.	N/A
2.1.1.2	Battery compartments	No battery compartment.	N/A
2.1.1.3	Access to ELV wiring	No ELV wiring in operator accessible area.	N/A





IEC 60950-1			
Clause	Requirement + Test	Result - Remark	Verdict

	Working voltage (V <sub>peak</sub> or V <sub>rms</sub> ); minimum distance through insulation (mm)		—
2.1.1.4	Access to hazardous voltage circuit wiring	No hazardous voltage wiring in operator accessible area.	N/A
2.1.1.5	Energy hazards .....	No energy hazard circuit in user accessible parts.	P
2.1.1.6	Manual controls	No conductive shaft of operating knob and handle.	N/A
2.1.1.7	Discharge of capacitors in equipment	Evaluated in approved internal power supply.	N/A
	Measured voltage (V); time-constant (s) .....	Same as above.	—
2.1.1.8	Energy hazards – d.c. mains supply	Mains from AC source.	N/A
	a) Capacitor connected to the d.c. mains supply ..	Same as above.	N/A
	b) Internal battery connected to the d.c. mains supply .....	Same as above.	N/A
2.1.1.9	Audio amplifiers .....	No audio amplifier provided.	N/A
2.1.2	Protection in service access areas	No maintenance work in operation mode necessary.	N/A
2.1.3	Protection in restricted access locations	The unit is not intended to be used in restricted locations.	N/A

<b>2.2</b>	<b>SELV circuits</b>		P
2.2.1	General requirements	See below.	P
2.2.2	Voltages under normal conditions (V) .....	Evaluated in approved building-in power supply unit.	P
2.2.3	Voltages under fault conditions (V) .....	Evaluated in approved building-in power supply unit.	P
2.2.4	Connection of SELV circuits to other circuits .....	See 2.2.2 and 2.2.3. No direct connection between SELV and any primary circuits.	N/A

<b>2.3</b>	<b>TNV circuits</b> <i>No TNV circuit within this equipment.</i>		N/A
2.3.1	Limits		N/A
	Type of TNV circuits .....		—
2.3.2	Separation from other circuits and from accessible parts		N/A



IEC 60950-1			
Clause	Requirement + Test	Result - Remark	Verdict
2.3.2.1	General requirements		N/A
2.3.2.2	Protection by basic insulation		N/A
2.3.2.3	Protection by earthing		N/A
2.3.2.4	Protection by other constructions .....		N/A
2.3.3	Separation from hazardous voltages		N/A
	Insulation employed.....		—
2.3.4	Connection of TNV circuits to other circuits		N/A
	Insulation employed.....		—
2.3.5	Test for operating voltages generated externally		N/A
<b>2.4</b>	<b>Limited current circuits</b> <i>Evaluated in approved building-in power supply unit.</i>		N/A
2.4.1	General requirements		N/A
2.4.2	Limit values		N/A
	Frequency (Hz) .....		—
	Measured current (mA) .....		—
	Measured voltage (V) .....		—
	Measured circuit capacitance (nF or µF).....		—
2.4.3	Connection of limited current circuits to other circuits		N/A
<b>2.5</b>	<b>Limited power sources</b>		P
	a) Inherently limited output	See appended table 2.5.	P
	b) Impedance limited output	See appended table 2.5.	P
	c) Regulating network limited output under normal operating and single fault condition	See appended table 2.5.	P
	d) Overcurrent protective device limited output		N/A
	Max. output voltage (V), max. output current (A), max. apparent power (VA) .....	See appended table 2.5.	—
	Current rating of overcurrent protective device (A) .:		—
	Use of integrated circuit (IC) current limiters	See appended table 1.5.1.	—
<b>2.6</b>	<b>Provisions for earthing and bonding</b>		P



IEC 60950-1			
Clause	Requirement + Test	Result - Remark	Verdict
2.6.1	Protective earthing	Evaluated in approved internal power supply.	N/A
2.6.2	Functional earthing	Secondary functional earthing is connected to protectively earthed conductive part that separated from primary by reinforced insulation.	P
2.6.3	Protective earthing and protective bonding conductors	See below.	P
2.6.3.1	General	Protective bonding conductors and functional earthing conductors have sufficient current-carrying capacity.	P
2.6.3.2	Size of protective earthing conductors	No power cord provided.	N/A
	Rated current (A), cross-sectional area (mm <sup>2</sup> ), AWG.....:	Same as above.	—
2.6.3.3	Size of protective bonding conductors	Protective bonding conductors evaluated based on 2.6.3.4.	P
	Rated current (A), cross-sectional area (mm <sup>2</sup> ), AWG.....:	Same as above.	—
	Protective current rating (A), cross-sectional area (mm <sup>2</sup> ), AWG.....:	Same as above.	—
2.6.3.4	Resistance of earthing conductors and their terminations; resistance (Ω), voltage drop (V), test current (A), duration (min) .....	Earth pin of AC inlet to metal enclosure: 0.0066Ω/0.2112V/32A/2 min.	P
2.6.3.5	Colour of insulation.....:	No green/yellow wire used except in approved power supply.	N/A
2.6.4	Terminals	See below.	P
2.6.4.1	General	Appliance inlet considered as protective earthing terminal.	P
2.6.4.2	Protective earthing and bonding terminals	Appliance inlet considered as protective earthing terminal. Protective bonding conductors evaluated based on 2.6.3.4.	P
	Rated current (A), type, nominal thread diameter (mm) .....	Same as above.	—
2.6.4.3	Separation of the protective earthing conductor from protective bonding conductors	Appliance inlet used.	P
2.6.5	Integrity of protective earthing	See below.	P



IEC 60950-1			
Clause	Requirement + Test	Result - Remark	Verdict
2.6.5.1	Interconnection of equipment	This unit has its own earthing connection. Any other units connected via the DC output connector shall provide SELV only.	P
2.6.5.2	Components in protective earthing conductors and protective bonding conductors	Neither switch nor overcurrent protective device in protective bonding conductor.	P
2.6.5.3	Disconnection of protective earth	It is not possible to disconnect earth without disconnecting mains as an appliance inlet of approved power supply is used.	P
2.6.5.4	Parts that can be removed by an operator	Appliance inlet was used.	P
2.6.5.5	Parts removed during servicing	Protective earthed parts cannot be removed in a way which impair safety.	P
2.6.5.6	Corrosion resistance	All part comprising the connections are plated and metal to metal which comply with annex J.	P
2.6.5.7	Screws for protective bonding	Adequate connection of protective bonding. No self-tapping or spaced thread screws. No self-tapping or spaced thread screws.	P
2.6.5.8	Reliance on telecommunication network or cable distribution system	No TNV.	N/A

<b>2.7</b>	<b>Overcurrent and earth fault protection in primary circuits</b> <i>Evaluated in approved building-in power supply unit.</i>		N/A
2.7.1	Basic requirements		N/A
	Instructions when protection relies on building installation		N/A
2.7.2	Faults not simulated in 5.3.7		N/A
2.7.3	Short-circuit backup protection		N/A
2.7.4	Number and location of protective devices .....		N/A
2.7.5	Protection by several devices		N/A
2.7.6	Warning to service personnel.....		N/A



IEC 60950-1			
Clause	Requirement + Test	Result - Remark	Verdict
<b>2.8</b>	<b>Safety interlocks</b> <i>No such device within this equipment.</i>		N/A
2.8.1	General principles		N/A
2.8.2	Protection requirements		N/A
2.8.3	Inadvertent reactivation		N/A
2.8.4	Fail-safe operation		N/A
	Protection against extreme hazard		N/A
2.8.5	Moving parts		N/A
2.8.6	Overriding		N/A
2.8.7	Switches, relays and their related circuits		N/A
2.8.7.1	Separation distances for contact gaps and their related circuits (mm) .....		N/A
2.8.7.2	Overload test		N/A
2.8.7.3	Endurance test		N/A
2.8.7.4	Electric strength test		N/A
2.8.8	Mechanical actuators		N/A
<b>2.9</b>	<b>Electrical insulation</b>		P
2.9.1	Properties of insulating materials	Natural rubber, asbestos or hygroscopic materials are not used.	P
2.9.2	Humidity conditioning	Carried out for 48 h.	P
	Relative humidity (%), temperature (°C) .....	95% R.H., 25°C.	—
2.9.3	Grade of insulation	The adequate levels of safety insulation is provided and maintained to comply with the requirements of this standard.	P
2.9.4	Separation from hazardous voltages	See below.	P
	Method(s) used .....	Method 1 used.	—
<b>2.10</b>	<b>Clearances, creepage distances and distances through insulation</b>		P
2.10.1	General	Approved power supply is used. Hence requirements of below sub-clauses are in compliance with IEC 60950-1:2005.	P



IEC 60950-1			
Clause	Requirement + Test	Result - Remark	Verdict
2.10.1.1	Frequency .....	The frequency does not exceeding 30kHz.	P
2.10.1.2	Pollution degrees .....	Pollution degree 2.	P
2.10.1.3	Reduced values for functional insulation	See sub-clause 5.3.4.	P
2.10.1.4	Intervening unconnected conductive parts	No such conductive parts.	N/A
2.10.1.5	Insulation with varying dimensions	Not applicable.	N/A
2.10.1.6	Special separation requirements	No TNV circuit.	N/A
2.10.1.7	Insulation in circuits generating starting pulses	No lamps.	N/A
2.10.2	Determination of working voltage	See below.	P
2.10.2.1	General	The rms and the peak voltage were measured in approved power supply.	P
2.10.2.2	RMS working voltage	Same as above.	P
2.10.2.3	Peak working voltage	Same as above.	P
2.10.3	Clearances	The rms and the peak voltage were measured in approved power supply.	P
2.10.3.1	General	Same as above.	P
2.10.3.2	Mains transient voltages	Normal transient voltage considered.	P
	a) AC mains supply .....	Overvoltage category II for primary circuit and transient voltage 2500Vpeak.	P
	b) Earthed d.c. mains supplies .....		N/A
	c) Unearthed d.c. mains supplies .....		N/A
	d) Battery operation .....		N/A
2.10.3.3	Clearances in primary circuits	Clearances distances inside power supply have been evaluated during type approval and are in compliance with the requirements of this standard.	P
2.10.3.4	Clearances in secondary circuits	See sub-clause 5.3.4.	N/A
2.10.3.5	Clearances in circuits having starting pulses	No lamps.	N/A
2.10.3.6	Transients from a.c. mains supply .....	See sub-clause 2.10.3.2.	P
2.10.3.7	Transients from d.c. mains supply .....		N/A
2.10.3.8	Transients from telecommunication networks and cable distribution systems .....		N/A



IEC 60950-1			
Clause	Requirement + Test	Result - Remark	Verdict
2.10.3.9	Measurement of transient voltage levels	See sub-clause 2.10.3.6.	N/A
	a) Transients from a mains supply		N/A
	For an a.c. mains supply .....		N/A
	For a d.c. mains supply .....		N/A
	b) Transients from a telecommunication network :		N/A
2.10.4	Creepage distances	Insulation between other parts in the equipment is functional. For details see sub-clause 5.3.4. Creepage distances inside power supply have been evaluated during type approval and are in compliance with the requirements of this standard.	P
2.10.4.1	General	Same as above.	P
2.10.4.2	Material group and comparative tracking index	Material group IIIb is assumed to be used.	P
	CTI tests .....	CTI rating for all materials are min. 100.	—
2.10.4.3	Minimum creepage distances	Evaluated in approved power supply.	N/A
<b>2.10.5</b>	<b>Solid insulation</b>	Evaluated in approved power supply.	N/A
2.10.5.1	General	See below.	P
2.10.5.2	Distances through insulation	See below.	P
2.10.5.3	Insulating compound as solid insulation	Evaluated in approved power supply.	N/A
2.10.5.4	Semiconductor devices	Evaluated in approved power supply.	N/A
2.10.5.5.	Cemented joints		N/A
2.10.5.6	Thin sheet material – General		N/A
2.10.5.7	Separable thin sheet material		N/A
	Number of layers (pcs) .....		—
2.10.5.8	Non-separable thin sheet material		N/A
2.10.5.9	Thin sheet material – standard test procedure	Not applicable.	N/A
	Electric strength test		—
2.10.5.10	Thin sheet material – alternative test procedure		N/A
	Electric strength test		—



<b>IEC 60950-1</b>			
Clause	Requirement + Test	Result - Remark	Verdict
2.10.5.11	Insulation in wound components		N/A
2.10.5.12	Wire in wound components		N/A
	Working voltage .....		N/A
	a) Basic insulation not under stress .....		N/A
	b) Basic, supplementary, reinforced insulation .....		N/A
	c) Compliance with Annex U .....		N/A
	Two wires in contact inside wound component; angle between 45° and 90° .....		N/A
2.10.5.13	Wire with solvent-based enamel in wound components		N/A
	Electric strength test		—
	Routine test		N/A
2.10.5.14	Additional insulation in wound components		N/A
	Working voltage .....		N/A
	- Basic insulation not under stress .....		N/A
	- Supplementary, reinforced insulation .....		N/A
<b>2.10.6</b>	<b>Construction of printed boards</b>	See below.	P
2.10.6.1	Uncoated printed boards	Evaluated in approved power supply.	N/A
2.10.6.2	Coated printed boards		N/A
2.10.6.3	Insulation between conductors on the same inner surface of a printed board		N/A
2.10.6.4	Insulation between conductors on different layers of a printed board		N/A
	Distance through insulation		N/A
	Number of insulation layers (pcs) .....		N/A
<b>2.10.7</b>	<b>Component external terminations</b>	Evaluated in approved power supply.	N/A
2.10.8	Tests on coated printed boards and coated components		N/A
2.10.8.1	Sample preparation and preliminary inspection		N/A
2.10.8.2	Thermal conditioning		N/A
2.10.8.3	Electric strength test		N/A
2.10.8.4	Abrasion resistance test		N/A





<b>IEC 60950-1</b>			
Clause	Requirement + Test	Result - Remark	Verdict
2.10.9	Thermal cycling	Certified sources of photo couplers used in approved power supply.	N/A
2.10.10	Test for Pollution Degree 1 environment and insulating compound	Certified sources of photo couplers used in approved power supply.	N/A
2.10.11	Tests for semiconductor devices and cemented joints		N/A
2.10.12	Enclosed and sealed parts		N/A
<b>3</b>	<b>WIRING, CONNECTIONS AND SUPPLY</b>		<b>P</b>
3.1	General		P
3.1.1	Current rating and overcurrent protection	All wires have suitable and adequate current capability.	P
3.1.2	Protection against mechanical damage	No sharp edge within this equipment.	P
3.1.3	Securing of internal wiring	All internal wiring is secured well.	P
3.1.4	Insulation of conductors	The conductors have adequate insulation ability.	P
3.1.5	Beads and ceramic insulators	Not used.	N/A
3.1.6	Screws for electrical contact pressure	No screw used for electrical connection.	N/A
3.1.7	Insulating materials in electrical connections	All current carrying connections are metal to metal.	N/A
3.1.8	Self-tapping and spaced thread screws	No self-tapping or spaced thread screws used.	N/A
3.1.9	Termination of conductors	See below.	P
	10 N pull test	Well secured and keep suitable spacing as the required value.	P
3.1.10	Sleeving on wiring	No sleeving used as supplementary insulation.	N/A
<b>3.2</b>	<b>Connection to a mains supply</b>		<b>P</b>
3.2.1	Means of connection	See below.	P
3.2.1.1	Connection to an a.c. mains supply	Appliance coupler used.	P



IEC 60950-1			
Clause	Requirement + Test	Result - Remark	Verdict
3.2.1.2	Connection to a d.c. mains supply	AC mains supply only.	N/A
3.2.2	Multiple supply connections	EUT has only single AC mains connection.	N/A
3.2.3	Permanently connected equipment	Not a permanently connected equipment.	N/A
	Number of conductors, diameter of cable and conduits (mm) .....		—
3.2.4	Appliance inlets	Evaluated in approved building-in power supply unit.	N/A
3.2.5	Power supply cords	No power cord provided.	N/A
3.2.5.1	AC power supply cords	Same as above.	N/A
	Type .....		—
	Rated current (A), cross-sectional area (mm <sup>2</sup> ), AWG .....		—
3.2.5.2	DC power supply cords	AC mains supply.	N/A
3.2.6	Cord anchorages and strain relief	No non-detachable power cords provided.	N/A
	Mass of equipment (kg), pull (N) .....		—
	Longitudinal displacement (mm) .....		—
3.2.7	Protection against mechanical damage	No parts under this unit likely to damage the power supply cord. No sharp edge.	N/A
3.2.8	Cord guards	No cord guard.	N/A
	Diameter or minor dimension D (mm); test mass (g) .....		—
	Radius of curvature of cord (mm).....		—
3.2.9	Supply wiring space	Not permanently connector and without non-detachable power supply cord.	N/A
<b>3.3</b>	<b>Wiring terminals for connection of external conductors</b> <i>Not permanently connected equipment.</i>		N/A
3.3.1	Wiring terminals		N/A
3.3.2	Connection of non-detachable power supply cords		N/A
3.3.3	Screw terminals		N/A
3.3.4	Conductor sizes to be connected		N/A



IEC 60950-1			
Clause	Requirement + Test	Result - Remark	Verdict

	Rated current (A), cord/cable type, cross-sectional area (mm <sup>2</sup> ) .....		—
3.3.5	Wiring terminal sizes		N/A
	Rated current (A), type, nominal thread diameter (mm) .....		—
3.3.6	Wiring terminal design		N/A
3.3.7	Grouping of wiring terminals		N/A
3.3.8	Stranded wire		N/A

<b>3.4</b>	<b>Disconnection from the mains supply</b>		P
3.4.1	General requirement	See below.	P
3.4.2	Disconnect devices	Appliance inlet used.	P
3.4.3	Permanently connected equipment	Not a permanently connected equipment.	N/A
3.4.4	Parts which remain energized	When plug or inlet is disconnected no remaining parts with hazardous voltage in the equipment.	P
3.4.5	Switches in flexible cords	No switches in flexible cords.	N/A
3.4.6	Number of poles - single-phase and d.c. equipment	The inlet disconnects both poles simultaneously.	P
3.4.7	Number of poles - three-phase equipment	Single-phase equipment.	N/A
3.4.8	Switches as disconnect devices	Appliance inlet used. No switch as disconnect device.	N/A
3.4.9	Plugs as disconnect devices	Appliance inlet used. No plugs as disconnect device.	N/A
3.4.10	Interconnected equipment	Interconnection with other equipment only via SELV outputs.	N/A
3.4.11	Multiple power sources	Single mains supply.	N/A

<b>3.5</b>	<b>Interconnection of equipment</b>		P
3.5.1	General requirements	See below.	P
3.5.2	Types of interconnection circuits .....	Interconnection circuit of SELV through sec connector.	P
3.5.3	ELV circuits as interconnection circuits	No ELV interconnection circuits	N/A



IEC 60950-1			
Clause	Requirement + Test	Result - Remark	Verdict
3.5.4	Data ports for additional equipment	Results see appended table 2.5.	P

<b>4</b>	<b>PHYSICAL REQUIREMENTS</b>		P
4.1	Stability		N/A
	Angle of 10°	Unit does not exceed 7.0kg.	N/A
	Test force (N) .....	Equipment is not a floor-standing unit.	N/A

<b>4.2</b>	<b>Mechanical strength</b>		P
4.2.1	General	See below	N/A
	Rack-mounted equipment.	Not such equipment.	N/A
4.2.2	Steady force test, 10 N	10N applied to all components other than enclosure.	P
4.2.3	Steady force test, 30 N	No internal enclosure used.	N/A
4.2.4	Steady force test, 250 N	250N applied to outer enclosure (Metal chassis). No energy or other hazards.	P
4.2.5	Impact test	Applied to metal chassis, after test, equipment still complies with sub-clause 4.2.1.	P
	Fall test	Same as above.	P
	Swing test	Same as above.	P
4.2.6	Drop test; height (mm) .....	Compiled with impact test.	N/A
4.2.7	Stress relief test		N/A
4.2.8	Cathode ray tubes	No CRT in the unit.	N/A
	Picture tube separately certified .....	Same as above.	N/A
4.2.9	High pressure lamps	No high pressure lamp provided.	N/A
4.2.10	Wall or ceiling mounted equipment; force (N) .....	Not wall or ceiling mounted equipment.	N/A
4.2.11	Rotating solid media	No such device provided.	N/A
	Test to cover on the door.....	Same as above.	N/A

<b>4.3</b>	<b>Design and construction</b>		P
------------	--------------------------------	--	---



IEC 60950-1			
Clause	Requirement + Test	Result - Remark	Verdict
4.3.1	Edges and corners	The outer surfaces of the equipment are smooth and rounded.	P
4.3.2	Handles and manual controls; force (N)..... :	No such handle or control.	N/A
4.3.3	Adjustable controls	No such control.	N/A
4.3.4	Securing of parts	Mechanical fixings in such a way designed that they will withstand mechanical stress occurring in normal use.	P
4.3.5	Connection by plugs and sockets	No such design provided.	N/A
4.3.6	Direct plug-in equipment	Not direct plug-in type.	N/A
	Torque .....		—
	Compliance with the relevant mains plug standard .....		N/A
4.3.7	Heating elements in earthed equipment	No heating element.	N/A
4.3.8	Batteries	See below.	P
	- Overcharging of a rechargeable battery		N/A
	- Unintentional charging of a non-rechargeable battery	See appended table 4.3.8 and 5.3.	P
	- Reverse charging of a rechargeable battery	No reverse charging is likely due to the construction design.	N/A
	- Excessive discharging rate for any battery	No excessive discharging is likely due to the construction design.	N/A
4.3.9	Oil and grease	EUT in intended use not considered to be exposed to oil and grease.	N/A
4.3.10	Dust, powders, liquids and gases	EUT in intended use does not produce dust or use powders, liquids or gases.	N/A
4.3.11	Containers for liquids or gases	No container within this equipment.	N/A
4.3.12	Flammable liquids .....	No liquid within this equipment.	N/A
	Quantity of liquid (l) .....	Same as above.	N/A
	Flash point (°C) .....	Same as above.	N/A
4.3.13	Radiation	See below.	P
4.3.13.1	General	See below.	P



<b>IEC 60950-1</b>			
Clause	Requirement + Test	Result - Remark	Verdict
4.3.13.2	Ionizing radiation	No ionizing radiation or flammable liquids present.	N/A
	Measured radiation (pA/kg) .....		—
	Measured high-voltage (kV) .....		—
	Measured focus voltage (kV) .....		—
	CRT markings .....		—
4.3.13.3	Effect of ultraviolet (UV) radiation on materials	No UV radiation.	N/A
	Part, property, retention after test, flammability classification .....	Same as above.	N/A
4.3.13.4	Human exposure to ultraviolet (UV) radiation .....	No UV radiation.	N/A
4.3.13.5	Lasers (including laser diodes) and LEDs	See below.	P
4.3.13.5.1	Lasers (including laser laser diodes)	See appended table 1.5.1.	P
	Laser class .....	Same as above.	—
4.3.13.5.2	Light emitting diodes (LEDs)	The LED is intended use as indicating light.	P
4.3.13.6	Other types .....	No such consideration.	N/A
<b>4.4</b>	<b>Protection against hazardous moving parts</b>		<b>P</b>
4.4.1	General	See below.	P
4.4.2	Protection in operator access areas .....	See sub-clause 4.4.5.1.	P
	Household and home/office document/media shredders	No such devices.	N/A
4.4.3	Protection in restricted access locations .....	Not for restricted access locations used	N/A
4.4.4	Protection in service access areas	See sub-clause 4.4.5.1.	P
4.4.5	Protection against moving fan blades	See below.	P
4.4.5.1	General	See below.	P



IEC 60950-1			
Clause	Requirement + Test	Result - Remark	Verdict
	Not considered to cause pain or injury. a).....:	<p><b>[Under normal operation condition]:</b></p> <p>For CPU Fan  <math>K \text{ factor} = 6 \times 10^{-7} (\text{m r}^2 \text{N}^2) = 6 \times 10^{-7} (0.015 \times 20^2 \times 8000^2) = 230.4.</math>  <math>\text{RPM} / 15000 + K / 2400 = 0.63 \leq 1.</math></p> <p>For System Fan  <math>K \text{ factor} = 6 \times 10^{-7} (\text{m r}^2 \text{N}^2) = 6 \times 10^{-7} (0.156 \times 60^2 \times 1800^2) = 1091.76</math>  <math>\text{RPM} / 15000 + K / 2400 = 0.58 \leq 1</math></p> <p><b>[Under single fault condition]:</b>                      See appended table 5.3.                      A moving fan blade is not considered likely to cause pain or injury.</p>	P
	Is considered to cause pain, not injury. b) .....	Same as above.	N/A
	Considered to cause injury. c) .....	Same as above.	N/A
4.4.5.2	Protection for users	Compliance clause 4.4.5.1 a).	P
	Use of symbol or warning .....	Same as above.	N/A
4.4.5.3	Protection for service persons	Compliance clause 4.4.5.1 a).	P
	Use of symbol or warning .....	Same as above.	N/A

<b>4.5</b>	<b>Thermal requirements</b>		P
4.5.1	General	See below.	P
4.5.2	Temperature tests	See appended table 4.5.	P
	Normal load condition per Annex L .....	Highest load according to 1.2.2.1 for this equipment is operated in link mode. See appended table 1.6.2.	—
4.5.3	Temperature limits for materials	See appended table 4.5.	P
4.5.4	Touch temperature limits	See appended table 4.5.	P
4.5.5	Resistance to abnormal heat .....	Investigated as an element of power supply certification.	N/A



IEC 60950-1			
Clause	Requirement + Test	Result - Remark	Verdict

<b>4.6</b>	<b>Openings in enclosures</b>		P
4.6.1	Top and side openings	See below.	P
	Dimensions (mm) .....:	See appended table 4.6.1, 4.6.2	—
4.6.2	Bottoms of fire enclosures	See below.	P
	Construction of the bottom, dimensions (mm) ...:	See appended table 4.6.1, 4.6.2	—
4.6.3	Doors or covers in fire enclosures	The door intended only for occasional use by the OPERATOR.	P
4.6.4	Openings in transportable equipment	Not such equipment.	N/A
4.6.4.1	Constructional design measures	Same as above.	N/A
	Dimensions (mm) .....:	Same as above.	—
4.6.4.2	Evaluation measures for larger openings	Same as above.	N/A
4.6.4.3	Use of metallized parts	Same as above.	N/A
4.6.5	Adhesives for constructional purposes	No such consideration.	N/A
	Conditioning temperature (°C), time (weeks) .....:	Same as above.	—

<b>4.7</b>	<b>Resistance to fire</b>		P
4.7.1	Reducing the risk of ignition and spread of flame	Use of materials with the required flammability classes.	P
	Method 1, selection and application of components wiring and materials	Except for the front bezel, see appended table 1.5.1.	P
	Method 2, application of all of simulated fault condition tests	For front bezel, see appended table 5.3.	P
4.7.2	Conditions for a fire enclosure	See below.	P
4.7.2.1	Parts requiring a fire enclosure	With having the following components: - Components in secondary (not supplied by LPS) The fire enclosure is required.	P
4.7.2.2	Parts not requiring a fire enclosure	See clause 4.7.2.1.	N/A
4.7.3	Materials		P
4.7.3.1	General	See appended table 1.5.1 for PCB material.	P
4.7.3.2	Materials for fire enclosures	See appended table 1.5.1	P





IEC 60950-1			
Clause	Requirement + Test	Result - Remark	Verdict
4.7.3.3	Materials for components and other parts outside fire enclosures		N/A
4.7.3.4	Materials for components and other parts inside fire enclosures	Internal components except small parts are V-2, HF-2 or better.	P
4.7.3.5	Materials for air filter assemblies	No air filter assembly within this equipment.	N/A
4.7.3.6	Materials used in high-voltage components	No high-voltage component within this equipment.	N/A

<b>5</b>	<b>ELECTRICAL REQUIREMENTS AND SIMULATED ABNORMAL CONDITIONS</b>		P
5.1	<b>Touch current and protective conductor current</b>		P
5.1.1	General	See sub-clauses 5.1.2 to 5.1.6.	P
5.1.2	Configuration of equipment under test (EUT)	See below.	P
5.1.2.1	Single connection to an a.c. mains supply	EUT has only single AC mains connection.	P
5.1.2.2	Redundant multiple connections to an a.c. mains supply	Same as above.	N/A
5.1.2.3	Simultaneous multiple connections to an a.c. mains supply	Same as above.	N/A
5.1.3	Test circuit	Equipment of figure 5A used.	P
5.1.4	Application of measuring instrument	Using measuring instrument in annex D.	P
5.1.5	Test procedure	The touch current was measured from primary to metal enclosure, plastic enclosure and output terminal (SELV).	P
5.1.6	Test measurements	See below.	P
	Supply voltage (V) .....	See appended table 5.1.6.	—
	Measured touch current (mA) .....	See appended table 5.1.6.	—
	Max. allowed touch current (mA) .....	See appended table 5.1.6.	—
	Measured protective conductor current (mA) .....	Not applicable.	—
	Max. allowed protective conductor current (mA) ...:	Not applicable.	—
5.1.7	Equipment with touch current exceeding 3,5 mA	Not exceeded 3.5mA.	N/A
5.1.7.1	General .....	Same as above.	N/A
5.1.7.2	Simultaneous multiple connections to the supply	Same as above.	N/A



<b>IEC 60950-1</b>			
Clause	Requirement + Test	Result - Remark	Verdict
5.1.8	Touch currents to telecommunication networks and cable distribution systems and from telecommunication networks	No telecommunication networks circuits or cable distribution system within equipment.	N/A
5.1.8.1	Limitation of the touch current to a telecommunication network or to a cable distribution system	Same as above.	N/A
	Supply voltage (V) .....		—
	Measured touch current (mA) .....		—
	Max. allowed touch current (mA) .....		—
5.1.8.2	Summation of touch currents from telecommunication networks	No telecommunication networks circuits within equipment.	N/A
	a) EUT with earthed telecommunication ports .....	Same above.	N/A
	b) EUT whose telecommunication ports have no reference to protective earth	Same above.	N/A
<b>5.2</b>	<b>Electric strength</b>		<b>P</b>
5.2.1	General	See appended table 5.2.	P
5.2.2	Test procedure	Table 5B used.	P
<b>5.3</b>	<b>Abnormal operating and fault conditions</b>		<b>P</b>
5.3.1	Protection against overload and abnormal operation	Abnormal operation test performed. (See appended table 5.3.)	P
5.3.2	Motors	See appended table 1.5.1 for details.	P
5.3.3	Transformers	Investigated as an element of power supply certification.	N/A
5.3.4	Functional insulation .....	Method c). See appended table 5.3.	P
5.3.5	Electromechanical components	No such components provided.	N/A
5.3.6	Audio amplifiers in ITE .....	No audio amplifier within this equipment.	N/A



<b>IEC 60950-1</b>			
Clause	Requirement + Test	Result - Remark	Verdict
5.3.7	Simulation of faults	Faults in primary/secondary components and operational insulation were already considered during the approval of the building-in power supply unit. Ventilation openings blocked and Fan stalled tested. See appended table 5.3.	P
5.3.8	Unattended equipment	No thermostat, temperature limiter nor thermal cut-out provided.	N/A
5.3.9	Compliance criteria for abnormal operating and fault conditions	See below.	P
5.3.9.1	During the tests	No fire occurs, no emit molten metal, no hazardous.	P
5.3.9.2	After the tests	The requirements of clause 5.2.2 and 2.10 are considered.	P
<b>6</b>	<b>CONNECTION TO TELECOMMUNICATION NETWORKS</b>		N/A
6.1	Protection of telecommunication network service persons, and users of other equipment connected to the network, from hazards in the equipment		N/A
6.1.1	Protection from hazardous voltages		N/A
6.1.2	Separation of the telecommunication network from earth		N/A
6.1.2.1	Requirements		N/A
	Supply voltage (V) .....		—
	Current in the test circuit (mA) .....		—
6.1.2.2	Exclusions .....		N/A
<b>6.2</b>	<b>Protection of equipment users from overvoltages on telecommunication networks</b>		N/A
6.2.1	Separation requirements		N/A
6.2.2	Electric strength test procedure		N/A
6.2.2.1	Impulse test		N/A
6.2.2.2	Steady-state test		N/A
6.2.2.3	Compliance criteria		N/A
<b>6.3</b>	<b>Protection of the telecommunication wiring system from overheating</b>		N/A



IEC 60950-1			
Clause	Requirement + Test	Result - Remark	Verdict

	Max. output current (A) .....		—
	Current limiting method .....		—

<b>7</b>	<b>CONNECTION TO CABLE DISTRIBUTION SYSTEMS</b>		N/A
7.1	General		N/A
7.2	Protection of cable distribution system service persons, and users of other equipment connected to the system, from hazardous voltages in the equipment		N/A
7.3	Protection of equipment users from overvoltages on the cable distribution system		N/A
7.4	Insulation between primary circuits and cable distribution systems		N/A
7.4.1	General		N/A
7.4.2	Voltage surge test		N/A
7.4.3	Impulse test		N/A

<b>A</b>	<b>ANNEX A, TESTS FOR RESISTANCE TO HEAT AND FIRE</b>		N/A
A.1	Flammability test for fire enclosures of movable equipment having a total mass exceeding 18 kg, and of stationary equipment (see 4.7.3.2)		N/A
A.1.1	Samples.....		—
	Wall thickness (mm).....		—
A.1.2	Conditioning of samples; temperature (°C) .....		N/A
A.1.3	Mounting of samples .....		N/A
A.1.4	Test flame (see IEC 60695-11-3)		N/A
	Flame A, B, C or D .....		—
A.1.5	Test procedure		N/A
A.1.6	Compliance criteria		N/A
	Sample 1 burning time (s) .....		—
	Sample 2 burning time (s) .....		—
	Sample 3 burning time (s) .....		—
A.2	Flammability test for fire enclosures of movable equipment having a total mass not exceeding 18 kg, and for material and components located inside fire enclosures (see 4.7.3.2 and 4.7.3.4)		N/A
A.2.1	Samples, material.....		—



IEC 60950-1			
Clause	Requirement + Test	Result - Remark	Verdict
	Wall thickness (mm).....:		—
A.2.2	Conditioning of samples; temperature (°C) .....		N/A
A.2.3	Mounting of samples .....		N/A
A.2.4	Test flame (see IEC 60695-11-4)		N/A
	Flame A, B or C .....		—
A.2.5	Test procedure		N/A
A.2.6	Compliance criteria		N/A
	Sample 1 burning time (s) .....		—
	Sample 2 burning time (s) .....		—
	Sample 3 burning time (s) .....		—
A.2.7	Alternative test acc. to IEC 60695-11-5, cl. 5 and 9		N/A
	Sample 1 burning time (s) .....		—
	Sample 2 burning time (s) .....		—
	Sample 3 burning time (s) .....		—
A.3	Hot flaming oil test (see 4.6.2)		N/A
A.3.1	Mounting of samples		N/A
A.3.2	Test procedure		N/A
A.3.3	Compliance criterion		N/A

<b>B</b>	<b>ANNEX B, MOTOR TESTS UNDER ABNORMAL CONDITIONS (see 4.7.2.2 and 5.3.2)</b>		N/A
B.1	General requirements		N/A
	Position .....		—
	Manufacturer .....		—
	Type .....		—
	Rated values .....		—
B.2	Test conditions		N/A
B.3	Maximum temperatures		N/A
B.4	Running overload test		N/A
B.5	Locked-rotor overload test		N/A
	Test duration (days) .....		—
	Electric strength test: test voltage (V) .....		—



IEC 60950-1			
Clause	Requirement + Test	Result - Remark	Verdict
B.6	Running overload test for d.c. motors in secondary circuits		N/A
B.6.1	General		N/A
B.6.2	Test procedure		N/A
B.6.3	Alternative test procedure		N/A
B.6.4	Electric strength test; test voltage (V) .....		N/A
B.7	Locked-rotor overload test for d.c. motors in secondary circuits		N/A
B.7.1	General		N/A
B.7.2	Test procedure		N/A
B.7.3	Alternative test procedure		N/A
B.7.4	Electric strength test; test voltage (V) .....		N/A
B.8	Test for motors with capacitors		N/A
B.9	Test for three-phase motors		N/A
B.10	Test for series motors		N/A
	Operating voltage (V) .....		—
<b>C</b>	<b>ANNEX C, TRANSFORMERS (see 1.5.4 and 5.3.3)</b>		N/A
	Position .....		—
	Manufacturer .....		—
	Type .....		—
	Rated values .....		—
	Method of protection.....		—
C.1	Overload test		N/A
C.2	Insulation		N/A
	Protection from displacement of windings.....		N/A
<b>D</b>	<b>ANNEX D, MEASURING INSTRUMENTS FOR TOUCH-CURRENT TESTS (see 5.1.4)</b>		P
D.1	Measuring instrument	Figure D1 used.	P
D.2	Alternative measuring instrument		N/A
<b>E</b>	<b>ANNEX E, TEMPERATURE RISE OF A WINDING (see 1.4.13)</b>		N/A



IEC 60950-1			
Clause	Requirement + Test	Result - Remark	Verdict
<b>F</b>	<b>ANNEX F, MEASUREMENT OF CLEARANCES AND CREEPAGE DISTANCES (see 2.10 and Annex G)</b>		<b>P</b>
<b>G</b>	<b>ANNEX G, ALTERNATIVE METHOD FOR DETERMINING MINIMUM CLEARANCES</b>		<b>N/A</b>
G.1	Clearances		N/A
G.1.1	General		N/A
G.1.2	Summary of the procedure for determining minimum clearances		N/A
G.2	Determination of mains transient voltage (V)		N/A
G.2.1	AC mains supply .....		N/A
G.2.2	Earthed d.c. mains supplies .....		N/A
G.2.3	Unearthed d.c. mains supplies .....		N/A
G.2.4	Battery operation .....		N/A
G.3	Determination of telecommunication network transient voltage (V) .....		N/A
G.4	Determination of required withstand voltage (V)		N/A
G.4.1	Mains transients and internal repetitive peaks .....		N/A
G.4.2	Transients from telecommunication networks .....		N/A
G.4.3	Combination of transients		N/A
G.4.4	Transients from cable distribution systems		N/A
G.5	Measurement of transient voltages (V)		N/A
	a) Transients from a mains supply		N/A
	For an a.c. mains supply		N/A
	For a d.c. mains supply		N/A
	b) Transients from a telecommunication network		N/A
G.6	Determination of minimum clearances .....		N/A
<b>H</b>	<b>ANNEX H, IONIZING RADIATION (see 4.3.13)</b>		<b>N/A</b>
<b>J</b>	<b>ANNEX J, TABLE OF ELECTROCHEMICAL POTENTIALS (see 2.6.5.6)</b>		<b>P</b>
	Metal(s) used .....	Metallic alloy.	—
<b>K</b>	<b>ANNEX K, THERMAL CONTROLS (see 1.5.3 and 5.3.8)</b>		<b>N/A</b>



IEC 60950-1			
Clause	Requirement + Test	Result - Remark	Verdict

K.1	Making and breaking capacity		N/A
K.2	Thermostat reliability; operating voltage (V) .....		N/A
K.3	Thermostat endurance test; operating voltage (V) .....		N/A
K.4	Temperature limiter endurance; operating voltage (V) .....		N/A
K.5	Thermal cut-out reliability		N/A
K.6	Stability of operation		N/A

<b>L</b>	<b>ANNEX L, NORMAL LOAD CONDITIONS FOR SOME TYPES OF ELECTRICAL BUSINESS EQUIPMENT (see 1.2.2.1 and 4.5.2)</b>		P
L.1	Typewriters		N/A
L.2	Adding machines and cash registers		N/A
L.3	Erasers		N/A
L.4	Pencil sharpeners		N/A
L.5	Duplicators and copy machines		N/A
L.6	Motor-operated files		N/A
L.7	Other business equipment	See sub-clause 1.6.2.	P

<b>M</b>	<b>ANNEX M, CRITERIA FOR TELEPHONE RINGING SIGNALS (see 2.3.1)</b>		N/A
M.1	Introduction		N/A
M.2	Method A		N/A
M.3	Method B		N/A
M.3.1	Ringling signal		N/A
M.3.1.1	Frequency (Hz) .....		—
M.3.1.2	Voltage (V) .....		—
M.3.1.3	Cadence; time (s), voltage (V) .....		—
M.3.1.4	Single fault current (mA) .....		—
M.3.2	Tripping device and monitoring voltage .....		N/A
M.3.2.1	Conditions for use of a tripping device or a monitoring voltage		N/A
M.3.2.2	Tripping device		N/A
M.3.2.3	Monitoring voltage (V) .....		N/A





<b>IEC 60950-1</b>			
Clause	Requirement + Test	Result - Remark	Verdict
<b>N</b>	<b>ANNEX N, IMPULSE TEST GENERATORS (see 1.5.7.2, 1.5.7.3, 2.10.3.9, 6.2.2.1, 7.3.2, 7.4.3 and Clause G.5)</b>		N/A
N.1	ITU-T impulse test generators		N/A
N.2	IEC 60065 impulse test generator		N/A
<b>P</b>	<b>ANNEX P, NORMATIVE REFERENCES</b>		—
<b>Q</b>	<b>ANNEX Q, Voltage dependent resistors (VDRs) (see 1.5.9.1)</b>		N/A
	a) Preferred climatic categories .....		N/A
	b) Maximum continuous voltage .....		N/A
	c) Pulse current .....		N/A
<b>R</b>	<b>ANNEX R, EXAMPLES OF REQUIREMENTS FOR QUALITY CONTROL PROGRAMMES</b>		N/A
R.1	Minimum separation distances for unpopulated coated printed boards (see 2.10.6.2)		N/A
R.2	Reduced clearances (see 2.10.3)		N/A
<b>S</b>	<b>ANNEX S, PROCEDURE FOR IMPULSE TESTING (see 6.2.2.3)</b>		N/A
S.1	Test equipment		N/A
S.2	Test procedure		N/A
S.3	Examples of waveforms during impulse testing		N/A
<b>T</b>	<b>ANNEX T, GUIDANCE ON PROTECTION AGAINST INGRESS OF WATER (see 1.1.2)</b>		N/A
			—
<b>U</b>	<b>ANNEX U, INSULATED WINDING WIRES FOR USE WITHOUT INTERLEAVED INSULATION (see 2.10.5.12)</b>		N/A
			—
<b>V</b>	<b>ANNEX V, AC POWER DISTRIBUTION SYSTEMS (see 1.6.1)</b>		P
V.1	Introduction	See below.	P



IEC 60950-1			
Clause	Requirement + Test	Result - Remark	Verdict
V.2	TN power distribution systems	Single-phase TN power system considered and used for the testing.	P
<b>W</b>	<b>ANNEX W, SUMMATION OF TOUCH CURRENTS</b>		N/A
W.1	Touch current from electronic circuits		N/A
W.1.1	Floating circuits		N/A
W.1.2	Earthed circuits		N/A
W.2	Interconnection of several equipments		N/A
W.2.1	Isolation		N/A
W.2.2	Common return, isolated from earth		N/A
W.2.3	Common return, connected to protective earth		N/A
<b>X</b>	<b>ANNEX X, MAXIMUM HEATING EFFECT IN TRANSFORMER TESTS (see clause C.1)</b>		N/A
X.1	Determination of maximum input current		N/A
X.2	Overload test procedure		N/A
<b>Y</b>	<b>ANNEX Y, ULTRAVIOLET LIGHT CONDITIONING TEST (see 4.3.13.3)</b>		N/A
Y.1	Test apparatus .....		N/A
Y.2	Mounting of test samples .....		N/A
Y.3	Carbon-arc light-exposure apparatus .....		N/A
Y.4	Xenon-arc light exposure apparatus .....		N/A
<b>Z</b>	<b>ANNEX Z, OVERVOLTAGE CATEGORIES (see 2.10.3.2 and Clause G.2)</b>		N/A
<b>AA</b>	<b>ANNEX AA, MANDREL TEST (see 2.10.5.8)</b>		N/A
<b>BB</b>	<b>ANNEX BB, CHANGES IN THE SECOND EDITION</b>		—
<b>CC</b>	<b>ANNEX CC, Evaluation of integrated circuit (IC) current limiters</b>		N/A
CC.1	General		N/A
CC.2	Test program 1.....		N/A
CC.3	Test program 2.....		N/A



<b>IEC 60950-1</b>			
Clause	Requirement + Test	Result - Remark	Verdict
<b>DD</b>	<b>ANNEX DD, Requirements for the mounting means of rack-mounted equipment</b>		N/A
DD.1	General		N/A
DD.2	Mechanical strength test, variable N.....:		N/A
DD.3	Mechanical strength test, 250N, including end stops.....:		N/A
DD.4	Compliance.....:		N/A
<b>EE</b>	<b>ANNEX EE, Household and home/office document/media shredders</b>		N/A
EE.1	General		N/A
EE.2	Markings and instructions		N/A
	Use of markings or symbols.....:		N/A
	Information of user instructions, maintenance and/or servicing instructions.....:		N/A
EE.3	Inadvertent reactivation test.....:		N/A
EE.4	Disconnection of power to hazardous moving parts:		N/A
	Use of markings or symbols.....:		N/A
EE.5	Protection against hazardous moving parts		N/A
	Test with test finger (Figure 2A) .....		N/A
	Test with wedge probe (Figure EE1 and EE2) .....		N/A



IEC 60950-1			
Clause	Requirement + Test	Result - Remark	Verdict

**EN 60950-1:2006/A11:2009/A1:2010/A12:2011 – CENELEC COMMON MODIFICATIONS**

Contents	Add the following annexes: Annex ZA (normative) Normative references to international publications with their corresponding European publications Annex ZB (normative) Special national conditions		P
General	Delete all the "country" notes in the reference document (IEC 60950-1:2005) according to the following list: 1.4.8 Note 2      1.5.1 Note 2 & 3      1.5.7.1 Note 1.5.8 Note 2      1.5.9.4 Note      1.7.2.1 Note 4, 5 & 6 2.2.3 Note      2.2.4 Note      2.3.2 Note 2.3.2.1 Note 2      2.3.4 Note 2      2.6.3.3 Note 2 & 3 2.7.1 Note      2.10.3.2 Note 2      2.10.5.13 Note 3 3.2.1.1 Note      3.2.4 Note 3.      2.5.1 Note 2 4.3.6 Note 1 & 2      4.7 Note 4      4.7.2.2 Note 4.7.3.1 Note 2      5.1.7.1 Note 3 & 4      5.3.7 Note 1 6 Note 2 & 5      6.1.2.1 Note 2      6.1.2.2 Note 6.2.2 Note      6.2.2.1 Note 2      6.2.2.2 Note 7.1 Note 3      7.2 Note      7.3 Note 1 & 2 G.2.1 Note 2      Annex H Note 2		P
General (A1:2010)	Delete all the "country" notes in the reference document (IEC 60950-1:2005/A1:2010) according to the following list: 1.5.7.1 Note      6.1.2.1 Note 2 6.2.2.1 Note 2      EE.3 Note		P
1.3.Z1	Add the following subclause: 1.3.Z1 Exposure to excessive sound pressure The apparatus shall be so designed and constructed as to present no danger when used for its intended purpose, either in normal operating conditions or under fault conditions, particularly providing protection against exposure to excessive sound pressures from headphones or earphones. NOTE Z1 A new method of measurement is described in EN 50332-1, Sound system equipment: Headphones and earphones associated with portable audio equipment - Maximum sound pressure level measurement methodology and limit considerations - Part 1: General method for "one package equipment", and in EN 50332-2, Sound system equipment: Headphones and earphones associated with portable audio equipment - Maximum sound pressure level measurement methodology and limit considerations - Part 2: Guidelines to associate sets with headphones coming from different manufacturers.		P



IEC 60950-1			
Clause	Requirement + Test	Result - Remark	Verdict
(A12:2011)	In EN 60950-1:2006/A12:2011 Delete the addition of 1.3.Z1 / EN 60950-1:2006 Delete the definition 1.2.3.Z1 / EN 60950-1:2006 /A1:2010		P
1.5.1	Add the following NOTE: NOTE Z1 The use of certain substances in electrical and electronic equipment is restricted within the EU: see Directive 2002/95/EC		P
1.7.2.1 (A1:2010)	In addition, for a PORTABLE SOUND SYSTEM, the instructions shall include a warning that excessive sound pressure from earphones and headphones can cause hearing loss.		N/A
1.7.2.1 (A12:2011)	In EN 60950-1:2006/A12:2011 Delete NOTE Z1 and the addition for Portable Sound System. Add the following clause and annex to the existing standard and amendments.		N/A
	<b>Zx Protection against excessive sound pressure from personal music players</b>		N/A



IEC 60950-1			
Clause	Requirement + Test	Result - Remark	Verdict
	<p><b>Zx.1 General</b>                      This sub-clause specifies requirements for protection against excessive sound pressure from personal music players that are closely coupled to the ear. It also specifies requirements for earphones and headphones intended for use with personal music players.</p> <p>A personal music player is a portable equipment for personal use, that:                      is designed to allow the user to listen to recorded or broadcast sound or video; and                      primarily uses headphones or earphones that can be worn in or on or around the ears; and                      allows the user to walk around while in use.</p> <p>NOTE 1 Examples are hand-held or body-worn portable CD players, MP3 audio players, mobile phones with MP3 type features, PDA's or similar equipment.</p> <p>A personal music player and earphones or headphones intended to be used with personal music players shall comply with the requirements of this sub-clause.</p> <p>The requirements in this sub-clause are valid for music or video mode only.</p> <p>The requirements do not apply:                      while the personal music player is connected to an external amplifier; or                      while the headphones or earphones are not used.</p> <p>NOTE 2 An external amplifier is an amplifier which is not part of the personal music player or the listening device, but which is intended to play the music as a standalone music player.</p> <p>The requirements do not apply to:                      hearing aid equipment and professional equipment;</p> <p>NOTE 3 Professional equipment is equipment sold through special sales channels. All products sold through normal electronics stores are considered not to be professional equipment.</p>		N/A



IEC 60950-1			
Clause	Requirement + Test	Result - Remark	Verdict
	<p>analogue personal music players (personal music players without any kind of digital processing of the sound signal) that are brought to the market before the end of 2015.</p> <p>NOTE 4 This exemption has been allowed because this technology is falling out of use and it is expected that within a few years it will no longer exist. This exemption will not be extended to other technologies.</p> <p>For equipment which is clearly designed or intended for use by young children, the limits of EN 71-1 apply.</p>		N/A
	<p><b>Zx.2 Equipment requirements</b></p> <p>No safety provision is required for equipment that complies with the following:</p> <ul style="list-style-type: none"> <li>equipment provided as a package (personal music player with its listening device), where the acoustic output <math>L_{Aeq,T}</math> is <math>\leq 85</math> dBA measured while playing the fixed "programme simulation noise" as described in EN 50332-1; and</li> <li>a personal music player provided with an analogue electrical output socket for a listening device, where the electrical output is <math>\leq 27</math> mV measured as described in EN 50332-2, while playing the fixed "programme simulation noise" as described in EN 50332-1.</li> </ul> <p>NOTE 1 Wherever the term acoustic output is used in this clause, the 30 s A-weighted equivalent sound pressure level <math>L_{Aeq,T}</math> is meant. See also Zx.5 and Annex Zx.</p> <p>All other equipment shall:</p> <ul style="list-style-type: none"> <li>a) protect the user from unintentional acoustic outputs exceeding those mentioned above; and</li> <li>b) have a standard acoustic output level not exceeding those mentioned above, and automatically return to an output level not exceeding those mentioned above when the power is switched off; and</li> </ul>		N/A



IEC 60950-1			
Clause	Requirement + Test	Result - Remark	Verdict
	<p>c) provide a means to actively inform the user of the increased sound pressure when the equipment is operated with an acoustic output exceeding those mentioned above. Any means used shall be acknowledged by the user before activating a mode of operation which allows for an acoustic output exceeding those mentioned above. The acknowledgement does not need to be repeated more than once every 20 h of cumulative listening time; and</p> <p>NOTE 2 Examples of means include visual or audible signals. Action from the user is always required.</p> <p>NOTE 3 The 20 h listening time is the accumulative listening time, independent how often and how long the personal music player has been switched off.</p> <p>d) have a warning as specified in Zx.3; and</p> <p>e) not exceed the following:</p> <ol style="list-style-type: none"> <li>1) equipment provided as a package (player with its listening device), the acoustic output shall be <math>\leq 100</math> dBA measured while playing the fixed "programme simulation noise" described in EN 50332-1; and</li> <li>2) a personal music player provided with an analogue electrical output socket for a listening device, the electrical output shall be <math>\leq 150</math> mV measured as described in EN 50332-2, while playing the fixed "programme simulation noise" described in EN 50332-1.</li> </ol> <p>For music where the average sound pressure (long term <math>L_{Aeq,T}</math>) measured over the duration of the song is lower than the average produced by the programme simulation noise, the warning does not need to be given as long as the average sound pressure of the song is below the basic limit of 85 dBA. In this case T becomes the duration of the song.</p> <p>NOTE 4 Classical music typically has an average sound pressure (long term <math>L_{Aeq,T}</math>) which is much lower than the average programme simulation noise. Therefore, if the player is capable to analyse the song and compare it with the programme simulation noise, the warning does not need to be given as long as the average sound pressure of the song is below the basic limit of 85 dBA.</p> <p>For example, if the player is set with the programme simulation noise to 85 dBA, but the average music level of the song is only 65 dBA, there is no need to give a warning or ask an acknowledgement as long as the average sound level of the song is not above the basic limit of 85 dBA.</p>		N/A





IEC 60950-1			
Clause	Requirement + Test	Result - Remark	Verdict
	<p><b>Zx.3 Warning</b>                      The warning shall be placed on the equipment, or on the packaging, or in the instruction manual and shall consist of the following:                      the symbol of Figure 1 with a minimum height of 5 mm; and                      the following wording, or similar:                      “To prevent possible hearing damage, do not listen at high volume levels for long periods.”</p>  <p><b>Figure 1 – Warning label (IEC 60417-6044)</b></p> <p>Alternatively, the entire warning may be given through the equipment display during use, when the user is asked to acknowledge activation of the higher level.</p>		N/A
	<p><b>Zx.4 Requirements for listening devices (headphones and earphones)</b></p>		N/A
	<p><b>Zx.4.1 Wired listening devices with analogue input</b>                      With 94 dBA sound pressure output <math>L_{Aeq,T}</math>, the input voltage of the fixed “programme simulation noise” described in EN 50332-2 shall be <math>\geq 75</math> mV.                      This requirement is applicable in any mode where the headphones can operate (active or passive), including any available setting (for example built-in volume level control).                      NOTE The values of 94 dBA – 75 mV correspond with 85dBA – 27 mV and 100 dBA – 150 mV.</p>		N/A



IEC 60950-1			
Clause	Requirement + Test	Result - Remark	Verdict
	<p><b>Zx.4.2 Wired listening devices with digital input</b>                      With any playing device playing the fixed "programme simulation noise" described in EN 50332-1 (and respecting the digital interface standards, where a digital interface standard exists that specifies the equivalent acoustic level), the acoustic output <math>L_{Aeq,T}</math> of the listening device shall be <math>\leq 100</math> dBA.</p> <p>This requirement is applicable in any mode where the headphones can operate, including any available setting (for example built-in volume level control, additional sound feature like equalization, etc.).</p> <p>NOTE An example of a wired listening device with digital input is a USB headphone.</p>		N/A
	<p><b>Zx.4.3 Wireless listening devices</b>                      In wireless mode:                      with any playing and transmitting device playing the fixed programme simulation noise described in EN 50332-1; and respecting the wireless transmission standards, where an air interface standard exists that specifies the equivalent acoustic level; and with volume and sound settings in the listening device (for example built-in volume level control, additional sound feature like equalization, etc.) set to the combination of positions that maximize the measured acoustic output for the abovementioned programme simulation noise, the acoustic output <math>L_{Aeq,T}</math> of the listening device shall be <math>\leq 100</math> dBA.</p> <p>NOTE An example of a wireless listening device is a Bluetooth headphone.</p>		N/A
	<p><b>Zx.5 Measurement methods</b>                      Measurements shall be made in accordance with EN 50332-1 or EN 50332-2 as applicable. Unless stated otherwise, the time interval T shall be 30 s.</p> <p>NOTE Test method for wireless equipment provided without listening device should be defined.</p>		N/A



IEC 60950-1			
Clause	Requirement + Test	Result - Remark	Verdict
2.7.1	<p>Replace the subclause as follows:</p> <p>Basic requirements</p> <p>To protect against excessive current, short-circuits and earth faults in PRIMARY CIRCUITS, protective devices shall be included either as integral parts of the equipment or as parts of the building installation, subject to the following, a), b) and c):</p> <p>a) except as detailed in b) and c), protective devices necessary to comply with the requirements of 5.3 shall be included as parts of the equipment;</p> <p>b) for components in series with the mains input to the equipment such as the supply cord, appliance coupler, r.f.i. filter and switch, short-circuit and earth fault protection may be provided by protective devices in the building installation;</p>		N/A
	<p>c) it is permitted for PLUGGABLE EQUIPMENT TYPE B or PERMANENTLY CONNECTED EQUIPMENT, to rely on dedicated overcurrent and short-circuit protection in the building installation, provided that the means of protection, e.g. fuses or circuit breakers, is fully specified in the installation instructions.</p> <p>If reliance is placed on protection in the building installation, the installation instructions shall so state, except that for PLUGGABLE EQUIPMENT TYPE A the building installation shall be regarded as providing protection in accordance with the rating of the wall socket outlet.</p>		N/A
2.7.2	This subclause has been declared 'void'.		N/A
3.2.3	Delete the NOTE in Table 3A, and delete also in this table the conduit sizes in parentheses.		N/A



IEC 60950-1									
Clause	Requirement + Test	Result - Remark	Verdict						
3.2.5.1	<p>Replace “60245 IEC 53” by “H05 RR-F”;                      “60227 IEC 52” by “H03 VV-F or H03 VVH2-F”;                      “60227 IEC 53” by “H05 VV-F or H05 VVH2-F2”.</p> <p>In Table 3B, replace the first four lines by the following:</p> <table border="0"> <tr> <td>Up to and including 6  </td> <td>0,75<sup>a)</sup>  </td> </tr> <tr> <td>Over 6 up to and including 10  </td> <td>(0,75)<sup>b)</sup> 1,0  </td> </tr> <tr> <td>Over 10 up to and including 16  </td> <td>(1,0)<sup>c)</sup> 1,5  </td> </tr> </table> <p>In the conditions applicable to Table 3B delete the words “in some countries” in condition<sup>a)</sup>.</p> <p>In NOTE 1, applicable to Table 3B, delete the second sentence.</p>	Up to and including 6	0,75 <sup>a)</sup>	Over 6 up to and including 10	(0,75) <sup>b)</sup> 1,0	Over 10 up to and including 16	(1,0) <sup>c)</sup> 1,5		N/A
Up to and including 6	0,75 <sup>a)</sup>								
Over 6 up to and including 10	(0,75) <sup>b)</sup> 1,0								
Over 10 up to and including 16	(1,0) <sup>c)</sup> 1,5								
3.3.4	<p>In Table 3D, delete the fourth line: conductor sizes for 10 to 13 A, and replace with the following:</p> <table border="0"> <tr> <td>Over 10 up to and including 16  </td> <td>1,5 to 2,5  </td> <td>1,5 to 4  </td> </tr> </table> <p>Delete the fifth line: conductor sizes for 13 to 16 A</p>	Over 10 up to and including 16	1,5 to 2,5	1,5 to 4		N/A			
Over 10 up to and including 16	1,5 to 2,5	1,5 to 4							
4.3.13.6 (A1:2010)	<p>Replace the existing NOTE by the following:</p> <p>NOTE Z1 Attention is drawn to:</p> <p>1999/519/EC: Council Recommendation on the limitation of exposure of the general public to electromagnetic fields 0 Hz to 300 GHz, and</p> <p>2006/25/EC: Directive on the minimum health and safety requirements regarding the exposure of workers to risks arising from physical agents (artificial optical radiation).</p>		N/A						
	<p>Standards taking into account mentioned Recommendation and Directive which demonstrate compliance with the applicable EU Directive are indicated in the OJEC.</p>		N/A						
Annex H	<p>Replace the last paragraph of this annex by:</p> <p>At any point 10 cm from the surface of the OPERATOR ACCESS AREA, the dose rate shall not exceed 1 μSv/h (0,1 mR/h) (see NOTE). Account is taken of the background level.</p> <p>Replace the notes as follows:</p> <p>NOTE These values appear in Directive 96/29/Euratom.</p> <p>Delete NOTE 2.</p>		N/A						
Bibliography	Additional EN standards.		—						



IEC 60950-1			
Clause	Requirement + Test	Result - Remark	Verdict

<b>ZA</b>	<b>NORMATIVE REFERENCES TO INTERNATIONAL PUBLICATIONS WITH THEIR CORRESPONDING EUROPEAN PUBLICATIONS</b>	—	
-----------	--	---	--

ZB ANNEX (normative) SPECIAL NATIONAL CONDITIONS (EN)			
Clause	Requirement + Test	Result - Remark	Verdict
1.2.4.1	In <b>Denmark</b> , certain types of Class I appliances (see 3.2.1.1) may be provided with a plug not establishing earthing conditions when inserted into Danish socket-outlets.		N/A
1.2.13.14	In <b>Norway</b> and <b>Sweden</b> , for requirements see 1.7.2.1 and 7.3 of this annex.		N/A
1.5.7.1	In <b>Finland, Norway</b> and <b>Sweden</b> , resistors bridging BASIC INSULATION in CLASS I PLUGGABLE EQUIPMENT TYPE A must comply with the requirements in 1.5.7.1. In addition when a single resistor is used, the resistor must withstand the resistor test in 1.5.7.2.		N/A
1.5.8	In <b>Norway</b> , due to the IT power system used (see annex V, Figure V.7), capacitors are required to be rated for the applicable line-to-line voltage (230 V).		N/A
1.5.9.4	In <b>Finland, Norway</b> and <b>Sweden</b> , the third dashed sentence is applicable only to equipment as defined in 6.1.2.2 of this annex.		N/A



IEC 60950-1			
Clause	Requirement + Test	Result - Remark	Verdict
1.7.2.1	<p>In <b>Finland, Norway</b> and <b>Sweden</b>, CLASS I PLUGGABLE EQUIPMENT TYPE A intended for connection to other equipment or a network shall, if safety relies on connection to protective earth or if surge suppressors are connected between the network terminals and accessible parts, have a marking stating that the equipment must be connected to an earthed mains socket-outlet.</p> <p>The marking text in the applicable countries shall be as follows:</p> <p>In Finland: "Laite on liitettävä suojakoskettimilla varustettuun pistorasiaan"</p> <p>In Norway: "Apparatet må tilkoples jordet stikkontakt"</p> <p>In Sweden: "Apparaten skall anslutas till jordat uttag"</p> <p>In <b>Norway</b> and <b>Sweden</b>, the screen of the cable distribution system is normally not earthed at the entrance of the building and there is normally no equipotential bonding system within the building. Therefore the protective earthing of the building installation need to be isolated from the screen of a cable distribution system.</p> <p>It is however accepted to provide the insulation external to the equipment by an adapter or an interconnection cable with galvanic isolator, which may be provided by e.g. a retailer.</p> <p>The user manual shall then have the following or similar information in Norwegian and Swedish language respectively, depending on in what country the equipment is intended to be used in:</p> <p>"Equipment connected to the protective earthing of the building installation through the mains connection or through other equipment with a connection to protective earthing – and to a cable distribution system using coaxial cable, may in some circumstances create a fire hazard. Connection to a cable distribution system has therefore to be provided through a device providing electrical isolation below a certain frequency range (galvanic isolator, see EN 60728-11)."</p>		N/A



IEC 60950-1			
Clause	Requirement + Test	Result - Remark	Verdict
	<p>NOTE In Norway, due to regulation for installations of cable distribution systems, and in Sweden, a galvanic isolator shall provide electrical insulation below 5 MHz. The insulation shall withstand a dielectric strength of 1,5 kV r.m.s., 50 Hz or 60 Hz, for 1 min.</p> <p>Translation to Norwegian (the Swedish text will also be accepted in Norway):            "Utstyr som er koplet til beskyttelsesjord via nettplugg og/eller via annet jordtilkoplet utstyr – og er tilkoplet et kabel-TV nett, kan forårsake brannfare. For å unngå dette skal det ved tilkopling av utstyret til kabel-TV nettet installeres en galvanisk isolator mellom utstyret og kabel- TV nettet."            Translation to Swedish:            "Utrustning som är kopplad till skyddsjord via jordat vägguttag och/eller via annan utrustning och samtidigt är kopplad till kabel-TV nät kan i vissa fall medföra risk för brand. För att undvika detta skall vid anslutning av utrustningen till kabel-TV nät galvanisk isolator finnas mellan utrustningen och kabel-TV nätet."</p>		N/A
1.7.5	<p>In <b>Denmark</b>, socket-outlets for providing power to other equipment shall be in accordance with the Heavy Current Regulations, Section 107-2-D1, Standard Sheet DK 1-3a, DK 1-5a or DK 1-7a, when used on Class I equipment. For STATIONARY EQUIPMENT the socket-outlet shall be in accordance with Standard Sheet DK 1-1b or DK 1-5a.</p> <p>For <b>CLASS II EQUIPMENT</b> the socket outlet shall be in accordance with Standard Sheet DKA 1-4a.</p>		N/A
2.2.4	In <b>Norway</b> , for requirements see 1.7.2.1, 6.1.2.1 and 6.1.2.2 of this annex.		N/A
2.3.2	In <b>Finland, Norway and Sweden</b> there are additional requirements for the insulation. See 6.1.2.1 and 6.1.2.2 of this annex.		N/A
2.3.4	In <b>Norway</b> , for requirements see 1.7.2.1, 6.1.2.1 and 6.1.2.2 of this annex.		N/A
2.6.3.3	In the <b>United Kingdom</b> , the current rating of the circuit shall be taken as 13 A, not 16 A.		N/A



IEC 60950-1			
Clause	Requirement + Test	Result - Remark	Verdict
2.7.1	In the <b>United Kingdom</b> , to protect against excessive currents and short-circuits in the PRIMARY CIRCUIT of DIRECT PLUG-IN EQUIPMENT, tests according to 5.3 shall be conducted, using an external protective device rated 30 A or 32 A. If these tests fail, suitable protective devices shall be included as integral parts of the DIRECT PLUG-IN EQUIPMENT, so that the requirements of 5.3 are met.		N/A
2.10.5.13	In <b>Finland, Norway and Sweden</b> , there are additional requirements for the insulation, see 6.1.2.1 and 6.1.2.2 of this annex.		N/A
3.2.1.1	<p>In <b>Switzerland</b>, supply cords of equipment having a RATED CURRENT not exceeding 10 A shall be provided with a plug complying with SEV 1011 or IEC 60884-1 and one of the following dimension sheets:</p> <p>SEV 6532-2.1991 Plug Type 15 3P+N+PE 250/400 V, 10 A</p> <p>SEV 6533-2.1991 Plug Type 11 L+N 250 V, 10 A</p> <p>SEV 6534-2.1991 Plug Type 12 L+N+PE 250 V, 10 A</p> <p>In general, EN 60309 applies for plugs for currents exceeding 10 A. However, a 16 A plug and socket-outlet system is being introduced in Switzerland, the plugs of which are according to the following dimension sheets, published in February 1998:</p> <p>SEV 5932-2.1998: Plug Type 25 , 3L+N+PE 230/400 V, 16 A</p> <p>SEV 5933-2.1998: Plug Type 21, L+N, 250 V, 16A</p> <p>SEV 5934-2.1998: Plug Type 23, L+N+PE 250 V, 1</p>		N/A





IEC 60950-1			
Clause	Requirement + Test	Result - Remark	Verdict
3.2.1.1	<p>In <b>Denmark</b>, supply cords of single-phase equipment having a rated current not exceeding 13 A shall be provided with a plug according to the Heavy Current Regulations, Section 107-2-D1.</p> <p>CLASS I EQUIPMENT provided with socket-outlets with earth contacts or which are intended to be used in locations where protection against indirect contact is required according to the wiring rules shall be provided with a plug in accordance with standard sheet DK 2-1a or DK 2-5a.</p> <p>If poly-phase equipment and single-phase equipment having a RATED CURRENT exceeding 13 A is provided with a supply cord with a plug, this plug shall be in accordance with the Heavy Current Regulations, Section 107-2-D1 or EN 60309-2.</p>		N/A
3.2.1.1	<p>In <b>Spain</b>, supply cords of single-phase equipment having a rated current not exceeding 10 A shall be provided with a plug according to UNE 20315:1994.</p> <p>Supply cords of single-phase equipment having a rated current not exceeding 2,5 A shall be provided with a plug according to UNE-EN 50075:1993.</p> <p>CLASS I EQUIPMENT provided with socket-outlets with earth contacts or which are intended to be used in locations where protection against indirect contact is required according to the wiring rules, shall be provided with a plug in accordance with standard UNE 20315:1994.</p> <p>If poly-phase equipment is provided with a supply cord with a plug, this plug shall be in accordance with UNE-EN 60309-2.</p>		N/A
3.2.1.1	<p>In the <b>United Kingdom</b>, apparatus which is fitted with a flexible cable or cord and is designed to be connected to a mains socket conforming to BS 1363 by means of that flexible cable or cord and plug, shall be fitted with a 'standard plug' in accordance with Statutory Instrument 1768:1994 - The Plugs and Sockets etc. (Safety) Regulations 1994, unless exempted by those regulations.</p> <p>NOTE 'Standard plug' is defined in SI 1768:1994 and essentially means an approved plug conforming to BS 1363 or an approved conversion plug.</p>		N/A



IEC 60950-1			
Clause	Requirement + Test	Result - Remark	Verdict
3.2.1.1	In <b>Ireland</b> , apparatus which is fitted with a flexible cable or cord and is designed to be connected to a mains socket conforming to I.S. 411 by means of that flexible cable or cord and plug, shall be fitted with a 13 A plug in accordance with Statutory Instrument 525:1997 - National Standards Authority of Ireland (section 28) (13 A Plugs and Conversion Adaptors for Domestic Use) Regulations 1997.		N/A
3.2.4	In <b>Switzerland</b> , for requirements see 3.2.1.1 of this annex.		N/A
3.2.5.1	In the <b>United Kingdom</b> , a power supply cord with conductor of 1,25 mm <sup>2</sup> is allowed for equipment with a rated current over 10 A and up to and including 13 A.		N/A
3.3.4	In the <b>United Kingdom</b> , the range of conductor sizes of flexible cords to be accepted by terminals for equipment with a RATED CURRENT of over 10 A up to and including 13 A is: • 1,25 mm <sup>2</sup> to 1,5 mm <sup>2</sup> nominal cross-sectional area.		N/A
4.3.6	In the <b>United Kingdom</b> , the torque test is performed using a socket outlet complying with BS 1363 part 1:1995, including Amendment 1:1997 and Amendment 2:2003 and the plug part of DIRECT PLUG-IN EQUIPMENT shall be assessed to BS 1363: Part 1, 12.1, 12.2, 12.3, 12.9, 12.11, 12.12, 12.13, 12.16 and 12.17, except that the test of 12.17 is performed at not less than 125 °C. Where the metal earth pin is replaced by an Insulated Shutter Opening Device (ISOD), the requirements of clauses 22.2 and 23 also apply.		N/A
4.3.6	In <b>Ireland</b> , DIRECT PLUG-IN EQUIPMENT is known as plug similar devices. Such devices shall comply with Statutory Instrument 526:1997 - National Standards Authority of Ireland (Section 28) (Electrical plugs, plug similar devices and sockets for domestic use) Regulations, 1997.		N/A



IEC 60950-1			
Clause	Requirement + Test	Result - Remark	Verdict
5.1.7.1	<p>In <b>Finland, Norway</b> and <b>Sweden</b> TOUCH CURRENT measurement results exceeding 3,5 mA r.m.s. are permitted only for the following equipment:</p> <ul style="list-style-type: none"><li>• STATIONARY PLUGGABLE EQUIPMENT TYPE A that is intended to be used in a RESTRICTED ACCESS LOCATION where equipotential bonding has been applied, for example, in a telecommunication centre; and has provision for a permanently connected PROTECTIVE EARTHING CONDUCTOR; and is provided with instructions for the installation of that conductor by a SERVICE PERSON;</li><li>• STATIONARY PLUGGABLE EQUIPMENT TYPE B;</li><li>• STATIONARY PERMANENTLY CONNECTED EQUIPMENT.</li></ul>		N/A



IEC 60950-1			
Clause	Requirement + Test	Result - Remark	Verdict
6.1.2.1 (A1:2010)	<p>In <b>Finland, Norway and Sweden</b>, add the following text between the first and second paragraph of the compliance clause:</p> <p>If this insulation is solid, including insulation forming part of a component, it shall at least consist of either</p> <ul style="list-style-type: none"><li>- two layers of thin sheet material, each of which shall pass the electric strength test below, or</li><li>- one layer having a distance through insulation of at least 0,4 mm, which shall pass the electric strength test below.</li></ul> <p>Alternatively for components, there is no distance through insulation requirements for the insulation consisting of an insulating compound completely filling the casing, so that CLEARANCES and CREEPAGE DISTANCES do not exist, if the component passes the electric strength test in accordance with the compliance clause below and in addition</p> <ul style="list-style-type: none"><li>- passes the tests and inspection criteria of 2.10.11 with an electric strength test of 1,5 kV multiplied by 1,6 (the electric strength test of 2.10.10 shall be performed using 1,5 kV), and</li><li>- is subject to ROUTINE TESTING for electric strength during manufacturing, using a test voltage of 1,5 kV.</li></ul>		N/A



IEC 60950-1			
Clause	Requirement + Test	Result - Remark	Verdict
	<p>It is permitted to bridge this insulation with an optocoupler complying with 2.10.5.4 b).</p> <p>It is permitted to bridge this insulation with a capacitor complying with EN 60384-14:2005, subclass Y2.</p> <p>A capacitor classified Y3 according to EN 60384-14:2005, may bridge this insulation under the following conditions:</p> <ul style="list-style-type: none"> <li>- the insulation requirements are satisfied by having a capacitor classified Y3 as defined by EN 60384-14, which in addition to the Y3 testing, is tested with an impulse test of 2,5 kV defined in EN 60950-1:2006, 6.2.2.1;</li> <li>- the additional testing shall be performed on all the test specimens as described in EN 60384-14;</li> <li>- the impulse test of 2,5 kV is to be performed before the endurance test in EN 60384-14, in the sequence of tests as described in EN 60384-14.</li> </ul>		N/A
6.1.2.2	<p>In <b>Finland, Norway</b> and <b>Sweden</b>, the exclusions are applicable for PERMANENTLY CONNECTED EQUIPMENT, PLUGGABLE EQUIPMENT TYPE B and equipment intended to be used in a RESTRICTED ACCESS LOCATION where equipotential bonding has been applied, e.g. in a telecommunication centre, and which has provision for a permanently connected PROTECTIVE EARTHING CONDUCTOR and is provided with instructions for the installation of that conductor by a SERVICE PERSON.</p>		N/A
7.2	<p>In <b>Finland, Norway</b> and <b>Sweden</b>, for requirements see 6.1.2.1 and 6.1.2.2 of this annex.</p> <p>The term TELECOMMUNICATION NETWORK in 6.1.2 being replaced by the term CABLE DISTRIBUTION SYSTEM.</p>		N/A
7.3	<p>In <b>Norway</b> and <b>Sweden</b>, for requirements see 1.2.13.14 and 1.7.2.1 of this annex.</p>		N/A
7.3	<p>In <b>Norway</b>, for installation conditions see EN 60728-11:2005.</p>		N/A



1.5.1	TABLE: List of critical components					P
Object/part No.	Manufacturer/ trademark	Type/model	Technical data	Standard (Edition / year)	Mark(s) of conformity <sup>1)</sup>	
Metal Chassis	--	--	Min. 0.8mm thickness.	--	--	
Plastic Enclosure (Front Bezel)	CHI MEI	PA-757(+)	HB. 1.57mm thickness min., 80°C.	UL 94, UL 746C	UL	
Building-in Power Supply	FSP	FSP150-50LG	I/P: AC 100-240V, 3-1.5A, 60-50Hz; O/P: +5V/13A max. +3.3V/10A max. +12V/10A max. -12V/0.3A max. +5VSB/2A max. (+3.3V & +5V= 85W max.) Total: 150W. Ambient: 50°C. Class I.	EN 60950-1: 2006+A11:2009+ A1:2010+A12:2011	TUV	
RTC Battery (BAT1)	PANASONIC	CR2032	Max. abnormal charge current: 10mA	UL 1642	UL	
Polyswitch (FS5) (For VGA port)	POLYTRONICS	SMD1812P110TF	6Vdc, 1.1A	IEC 60730-1 EN 60730-1	TUV	



Current-Limited Power Switch (U39, U41, U46) (For USB port)	DIODES	AP2... (The “...” in the model number represents alphanumeric characters (up to six alphanumeric characters) that may indicate device package options and minor non-safety critical variations of the device. Additional alphanumeric characters representing device package options may follow model number also representing minor non-safety critical variations in the device.)	2.7 – 5.5Vdc, 2.0A	IEC 60950-1:2005; Am1:2009 EN 60950-1:2006/A11:2009 /A1:2010 (Annex CC)	CB by NEMKO
System Fan (One set provided)	ADDA	AD1212LB-A76GL	12Vdc, 0.24A, 71.806CFM.	EN 60950-1:2006+A11+A1+A12	TUV
	--	--	12Vdc, 0.24A, 71.806CFM. min.	EN 60950-1:2006+A11:2009 or later version	TUV, VDE, Semko, Nemko, Demko, Fimko or other National Certification Body
CPU Fan (One set provided)	XIN CHANG FENG	DF0401012B2U N	12Vdc, 0.20A, 7.97CFM.	EN 60950-1:2006+A11:2009	TUV
	--	--	12Vdc, 0.20A, 7.97CFM min.	EN 60950-1:2006+A11:2009 or later version	TUV, VDE, Semko, Nemko, Demko, Fimko or other National Certification Body
PCB	Various	Various	V-1 or better, 105°C min.	UL 796	UL
Supplementary information: <sup>1)</sup> An asterisk indicates a mark that assures the agreed level of surveillance.					



1.6.2 TABLE: Electrical data (in normal conditions)						P
U (V)	I (A)	I <sub>rated</sub> (A)	P (W)	Fuse #	I <sub>fuse</sub> (A)	Condition/status
90Vac / 50Hz	0.84	--	75.2	F1	0.84	Maximum normal load.
90Vac / 60Hz	0.85	--	75.5	F1	0.85	Maximum normal load.
100Vac / 50Hz	0.74	3	74.4	F1	0.74	Maximum normal load.
100Vac / 50Hz	0.75	3	74.9	F1	0.75	Maximum normal load.
240Vac / 50Hz	0.37	3	72.6	F1	0.37	Maximum normal load.
240Vac / 60Hz	0.39	3	73.1	F1	0.39	Maximum normal load.
254Vac / 50Hz	0.37	--	72.8	F1	0.37	Maximum normal load.
254Vac / 60Hz	0.39	--	73.6	F1	0.39	Maximum normal load.
264Vac / 50Hz	0.38	--	73.0	F1	0.38	Maximum normal load.
264Vac / 60Hz	0.40	--	73.2	F1	0.40	Maximum normal load.
Supplementary information:						

2.1.1.5 c) 1) TABLE: max. V, A, VA test					N/A
Voltage (rated) (V)	Current (rated) (A)	Voltage (max.) (V)	Current (max.) (A)	VA (max.) (VA)	
supplementary information:					

2.1.1.5 c) 2) TABLE: stored energy			N/A
Capacitance C (µF)	Voltage U (V)	Energy E (J)	





supplementary information:

<b>2.2</b>	<b>TABLE: evaluation of voltage limiting components in SELV circuits</b>	N/A	
Component (measured between)	max. voltage (V) (normal operation)		Voltage Limiting Components
	V peak	V d.c.	
Fault test performed on voltage limiting components	Voltage measured (V) in SELV circuits (V peak or V d.c.)		
supplementary information:			

<b>2.5</b>	<b>TABLE: limited power sources</b>	P		
Circuit output tested: <b>See below.</b>				
Measured Uoc (V) with all load circuits disconnected: <b>See Below</b>				
Part	I <sub>sc</sub> (A)		VA	
	Meas.	Limit	Meas.	Limit
Normal: VGA Port ((VGA COM1)), Pin1-4,11 to 5-8,10 (GND), Uoc= 0Vdc.	0	8	0	100
Normal: VGA Port ((VGA COM1)), Pin9 to 5-8,10 (GND), Uoc= 5.06Vdc.	2.3	8	8.786	100
Normal: VGA Port ((VGA COM1)), Pin12,15 to 5-8,10 (GND), Uoc= 4.97Vdc.	0	8	0	100
Normal: VGA Port ((VGA COM1)), Pin13,14 to 5-8,10 (GND), Uoc= 5.15Vdc.	0	8	0	100



Normal: COM Port (VGA COM1), Pin1,2,6,8,9 to 5 (GND), Uoc= 0Vdc.	0	8	0	100
Normal: COM Port (VGA COM1), Pin3,5,7 to 5 (GND), Uoc= 9.7Vdc.	0	8	0	100
Normal: LAN Port (LAN USB1), Pin2-9 to GND, Uoc= 0Vdc.	0	8	0	100
Normal: USB Port (LAN USB1), Pin19,23 to 22,26 (GND), Uoc= 5.13Vdc.	1.9	8	8.21	100
Normal: USB Port (LAN USB1), Pin20,21,24,25 to 22,26 (GND), Uoc= 0Vdc.	0	8	0	100
Normal: LAN Port (LAN USB2), Pin2-9 to GND, Uoc= 0Vdc.	0	8	0	100
Normal: USB Port (LAN USB2), Pin19,23 to 22,26 (GND), Uoc= 5.15Vdc.	1.8	8	7.55	100
Normal: USB Port (LAN USB2), Pin20,21,24,25 to 22,26 (GND), Uoc= 0Vdc.	0	8	0	100
Normal: USB Port (JUSB2), Pin1,2 to 7,8 (GND), Uoc= 5.15Vdc.	1.9	8	8.1	100
Normal: USB Port (JUSB2), Pin3-6,10 to 7,8 (GND), Uoc= 0Vdc.	0	8	0	100
Normal: eSATA Port (ESATA1), Pin2,3,5,6 to 1,4,7 (GND), Uoc= 0Vdc.	0	8	0	100
Normal: AUDIO Port (AUDIO1), PinA2,A5,B2,B5,C2,C5 to A1,A3,B3,C3 (GND), Uoc= 0Vdc.	0	8	0	100
Normal: AUDIO Port (AUDIO1), PinA4,B4,C4 to A1,A3,B3,C3 (GND), Uoc= 2.1Vdc.	0	8	0	100



supplementary information:
<b>Test Voltage:</b> 240Vac.

<b>2.10.2</b>	<b>Table: working voltage measurement</b>	N/A	
Location	RMS voltage (V)	Peak voltage (V)	Comments
supplementary information:			

<b>2.10.3 and 2.10.4</b>	<b>TABLE: Clearance and creepage distance measurements</b>						N/A
Clearance (cl) and creepage distance (cr) at/of/between:	U peak (V)	U r.m.s. (V)	Required cl (mm)	cl (mm)	Required cr (mm)	cr (mm)	
Supplementary information:							

<b>2.10.5</b>	<b>TABLE: Distance through insulation measurements</b>					N/A
Distance through insulation (DTI) at/of:	U peak (V)	U rms (V)	Test voltage (V)	Required DTI (mm)	DTI (mm)	
Supplementary information:						



<b>4.3.8</b>	<b>TABLE: Batteries</b>								P
The tests of 4.3.8 are applicable only when appropriate battery data is not available						See below.		P	
Is it possible to install the battery in a reverse polarity position?						No		N/A	
	Non-rechargeable batteries			Rechargeable batteries					
	Discharging		Un-intentional charging	Charging		Discharging		Reversed charging	
	Meas. current	Manuf. Specs.		Meas. current	Manuf. Specs.	Meas. current	Manuf. Specs.	Meas. current	Manuf. Specs.
Max. current during normal condition	--	--	0mA	--	--	--	--	--	--
Max. current during fault condition	--	--	0mA (R230 Short)	--	--	--	--	--	--
Max. current during fault condition	--	--	3.29mA (D1 Pin1 to 2 Short)	--	--	--	--	--	--
Max. current during fault condition	--	--	3.05mA (D1 Pin1 to 3 Short)	--	--	--	--	--	--
Test results:									Verdict
- Chemical leaks						No.		Pass	
- Explosion of the battery						No.		Pass	
- Emission of flame or expulsion of molten metal						No.		Pass	
- Electric strength tests of equipment after completion of tests								N/A	
Supplementary information:									

<b>4.3.8</b>	<b>TABLE: Batteries</b>								P
Battery category .....: Lithium									
Manufacturer .....: See appended table 1.5.1.									
Type / model.....: See appended table 1.5.1.									
Voltage .....: See appended table 1.5.1.									
Capacity .....: --									



Tested and Certified by (incl. Ref. No.) .....: See appended table 4.3.8 an 5.3.

Circuit protection diagram: See below

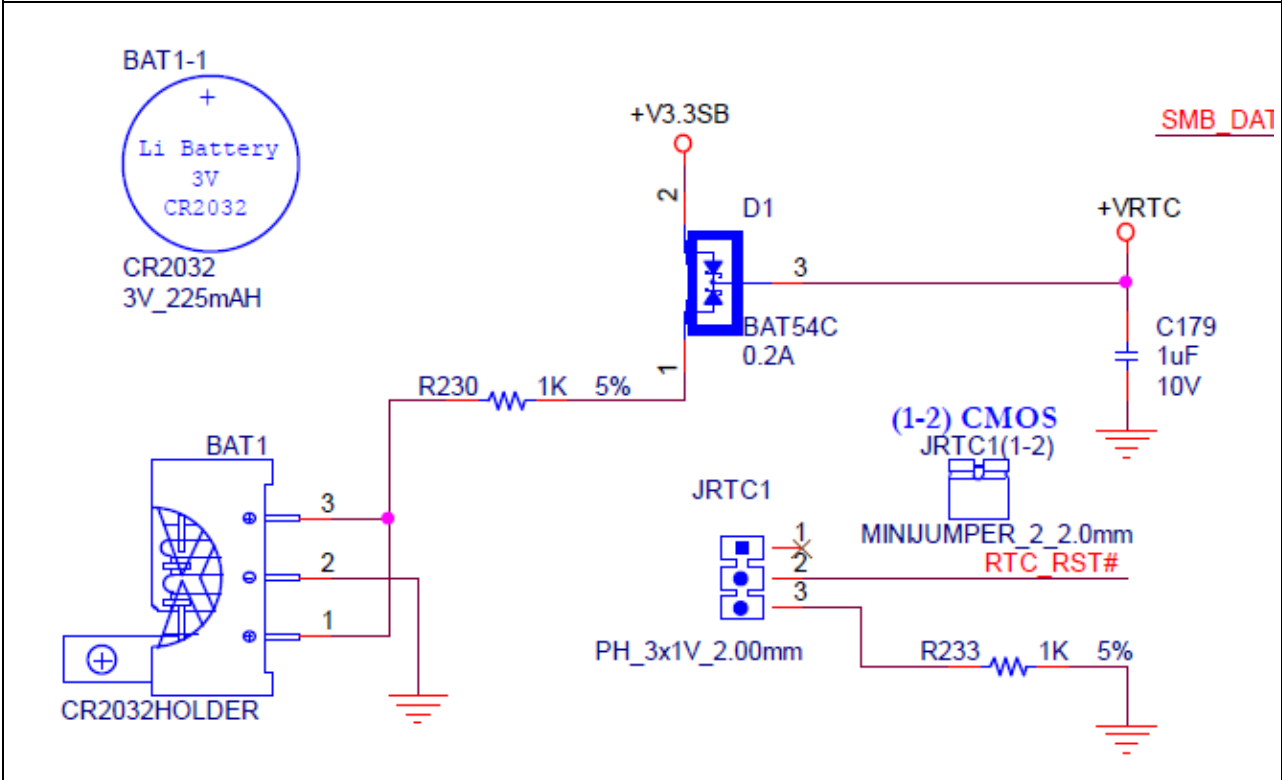

MARKINGS AND INSTRUCTIONS (1.7.2.1, 1.7.13)	
Location of replaceable battery	Not in OPERATOR ACCESS AREA.
Language(s) .....	English
Close to the battery .....	N/A
In the servicing instructions .....	CAUTION: RISK OF EXPLOSION IF BATTERY IS REPLACED BY INCORRECT TYPE. DISPOSE OF USED BATTERIES ACCORDING TO INSTRUCTIONS
In the operating instructions .....	N/A

4.5	TABLE: Thermal requirements		P
	Supply voltage (V) .....	See below	—
	Ambient T <sub>min</sub> (°C) .....	See below	—
	Ambient T <sub>max</sub> (°C) .....	See below	—
Maximum measured temperature T of part/at:		T (°C)	Allowed T <sub>max</sub> (°C)
<b>Test Condition</b>	<b>90Vac</b>	<b>264Vac</b>	--



<b>For Power Supply</b>							
AC Inlet		49.3		48.1		70	
LF1 coil		61.6		60.3		105	
1L1 coil		56.4		51.9		130	
T3 coil		59.9		59.4		105	
T1 secondary coil		54.5		54.2		110	
T1 core		52.8		52.6		110	
T1 primary coil		57.3		57.1		110	
T2 primary coil		48.3		48.0		110	
T2 secondary coil		48.1		47.8		110	
T2 core		45.9		45.5		110	
<b>For Main Board</b>							
PCB near U12		51.8		51.3		105	
PCB near U13		55.8		55.3		105	
BAT1 body		47.8		47.3		--	
<b>For Other Parts</b>							
Metal enclosure outside near power supply		42.9		42.5		70	
Plastic enclosure inside near power supply		40.8		41.0		--	
Plastic enclosure outside near power supply		40.7		40.3		95	
Heatsink on U12		51.6		51.0		70	
Heatsink on U13		51.5		50.8		70	
Tamb		22.7		22.9		--	
Tma		40.0		40.0		--	
Supplementary information:							
Temperature T of winding:	t <sub>1</sub> (°C)	R <sub>1</sub> (Ω)	t <sub>2</sub> (°C)	R <sub>2</sub> (Ω)	T (°C)	Allowed T <sub>max</sub> (°C)	Insulation class
Supplementary information:							
1. The temperature were measured under the worst case normal mode defined in 1.2.2.1 and as described in sub-clause 1.6.2 at voltage as described above.							
2. The user's manual defines the Tma at 40.0°C. Therefore the maximum permitted temperature are recalculated for the worst Tamb at 40.0°C.							



<b>4.5.5</b>	<b>TABLE: Ball pressure test of thermoplastic parts</b>		N/A
	Allowed impression diameter (mm) .....	≤ 2 mm	—
Part		Test temperature (°C)	Impression diameter (mm)
Supplementary information:			

<b>4.6.1, 4.6.2</b>	<b>Table: enclosure openings</b>		P
Location	Size (mm)	Comments	
<b>Plastic Enclosure</b>			
Front	Each 1.9 x 15.0mm max.	Several openings provided.	
Front (for HDD drawer)	Each 3.3 x 18.8mm max	Several openings provided.	
<b>Metal Chassis</b>			
Top	--	No opening.	
Left / Right	Each diameter 2.4 mm max.	Several openings provided that did not exceed 5.0mm in any dimension.	
Front	Each diameter 10.3 mm max.	Several openings provided. No hazardous parts within 5° projection area.	
	Each 16 x 3.5 mm max.	Several openings provided. No hazardous parts within 5° projection area.	
	Each 113.6 x 120.5 mm max.	Several openings provided. No hazardous parts within 5° projection area.	
Rear	Each diameter 4.96 mm max.	Several openings provided that did not exceed 5.0mm in any dimension.	
Rear (for power supply)	Each 3.0 x 3.05mm max.	Several openings provided that did not exceed 5.0mm in any dimension.	
Bottom	--	No opening.	
Note(s):			

<b>4.7</b>	<b>TABLE: Resistance to fire</b>				P
Part	Manufacturer of material	Type of material	Thickness (mm)	Flammability class	Evidence
Plastic Enclosure	--	--	1)	1)	1)
Metal Enclosure	--	--	1)	Metallic	1)
PCB	--	--	--	1)	1)



Supplementary information:  
 1) See appended table 1.5.1.

5.1	TABLE: touch current measurement			P
Measured between:	Measured (mA)	Limit (mA)	Comments/conditions	
System On	1.7	3.5	To output terminal (Switch "e" open)	
System On	1.7	3.5	To metal enclosure (Earth) (Switch "e" open)	
System On	0.01	0.25	To plastic enclosure (with metal foil) (Switch "e" closed)	
supplementary information:				

5.2	TABLE: Electric strength tests, impulse tests and voltage surge tests			P
Test voltage applied between:	Voltage shape (AC, DC, impulse, surge)	Test voltage (V)	Breakdown Yes / No	
Primary to SELV	DC	4242	No	
Primary to Plastic Enclosure (with metal foil)	AC	3000	No	
Primary to Metal Enclosure (Earth)	DC	3000	No	
Supplementary information:				

5.3	TABLE: Fault condition tests					P
	Ambient temperature (°C) .....		25°C, if no otherwise specified.		—	
	Power source for EUT: Manufacturer, model/type, output rating .....		See appended table 1.5.1.		—	
Component No.	Fault	Supply voltage (V)	Test time	Fuse #	Fuse current (A)	Observation
Ventilation Openings	Blocked	240Vac	2hr	F1	0.39	Unit operated normally. The maximum temperature of T1 secondary coil= 54.2°C, T1 core= 52.7°C, T1 primary oil= 55.8°C, T2 primary coil= 50.1°C, T2 secondary coil= 52.4°C, T2 core= 48.7°C. Ambient= 23.1°C. No hazardous. No damaged.





System Fan	Stalled	240Vac	1hr	F1	0.39	Unit operated normally. The maximum temperature of T1 secondary coil= 43.9°C, T1 core= 43.4°C, T1 primary oil= 46.3°C, T2 primary coil= 39.6°C, T2 secondary coil= 39.2°C, T2 core= 38.8°C. Ambient= 23.1°C. No hazardous. No damaged.
CPU Fan	Stalled	240Vac	45min	F1	0.39	Unit operated normally. The maximum temperature of T1 secondary coil= 38.4°C, T1 core= 36.8°C, T1 primary oil= 41.1°C, T2 primary coil= 32.6°C, T2 secondary coil= 32.4°C, T2 core= 30.5°C. Ambient= 23.1°C. No hazardous. No damaged.
Power Fan	Stalled	240Vac	2hr	F1	0.41	Unit operated normally. The maximum temperature of T1 secondary coil= 85.3°C, T1 core= 80.9°C, T1 primary oil= 88.9°C, T2 primary coil= 75.5°C, T2 secondary coil= 81.9°C, T2 core= 75.4°C. Ambient= 23.1°C. No hazardous. No damaged.
Q3 Pin 1 to 5 (For CPU fan)	Shorted	240Vac	30min	F1	0.39	Unit operated normally. No damage, No hazard. $K \text{ factor} = 6 \times 10^{-7} (\text{m r}^2 \text{N}^2) = 6 \times 10^{-7} (0.015 \times 20^2 \times 8000^2) = 230.4$ . $\text{RPM} / 15000 + K / 2400 = 0.63 \leq 1$ . CPU fan blade is not considered likely to cause pain or injury.
Q11 Pin 1 to 5 (For System fan)	Shorted	240Vac	30min	F1	0.39	Unit operated normally. No damage, No hazard. $K \text{ factor} = 6 \times 10^{-7} (\text{m r}^2 \text{N}^2) = 6 \times 10^{-7} (0.156 \times 60^2 \times 1800^2) = 1091.76$ . $\text{RPM} / 15000 + K / 2400 = 0.58 \leq 1$ . CPU fan blade is not considered likely to cause pain or injury.
<b>For RTC Circuit</b>						
R230	Shorted	240Vac	7hr	F1	0.39	No damage, no hazard.



D1 Pin1 to 2	Shorted	240Vac	7hr	F1	0.39	No damage, no hazard.
D1 Pin 1 to 3	Shorted	240Vac	7hr	F1	0.39	No damage, no hazard.
<b>For LED board</b>						
S1 Pin 1 to Pin2	Shorted	240Vac	30min	F1	0.39	Unit operated normally. No damage, No hazard.
S1 Pin1 to Pin3	Shorted	240Vac	30min	F1	0.39	Unit operated normally. No damage, No hazard.
S1 Pin1 to Pin4	Shorted	240Vac	30min	F1	0.39	Unit operated normally. No damage, No hazard.
S1 Pin2 to Pin3	Shorted	240Vac	30min	F1	0.39	Unit operated normally. No damage, No hazard.
S1 Pin2 to Pin4	Shorted	240Vac	30min	F1	0.39	Unit operated normally. No damage, No hazard.
S1 Pin3 to Pin4	Shorted	240Vac	30min	F1	0.39	Unit operated normally. No damage, No hazard.
S1 Pin1 to Pin3	Shorted	240Vac	30min	F1	0.39	Unit operated normally. No damage, No hazard.
S1 Pin1 to Pin4	Shorted	240Vac	30min	F1	0.39	Unit operated normally. No damage, No hazard.
S1 Pin2 to Pin3	Shorted	240Vac	30min	F1	0.39	Unit operated normally. No damage, No hazard.
S1 Pin2 to Pin4	Shorted	240Vac	30min	F1	0.39	Unit operated normally. No damage, No hazard.
S1 Pin3 to Pin4	Shorted	240Vac	10min	F1	0.15	Unit shutdown. No damage, No hazard.
S1 Pin1 to Pin3	Shorted	240Vac	30min	F1	0.39	Unit operated normally. No damage, No hazard.
S1 Pin1 to Pin4	Shorted	240Vac	10min	F1	0.15	Unit shutdown. No damage, No hazard.
S1 Pin2 to Pin3	Shorted	240Vac	30min	F1	0.39	Unit operated normally. No damage, No hazard.
LED1	Shorted	240Vac	30min	F1	0.39	Unit operated normally. No damage, No hazard.
LED1	Opened	240Vac	30min	F1	0.39	Unit operated normally. No damage, No hazard.



PWR_BT1 Pin1 to Pin2	Shorted	240Vac	30min	F1	0.39	Unit operated normally. No damage, No hazard.
PWR_BT1 Pin1 to Pin3	Shorted	240Vac	30min	F1	0.39	Unit operated normally. No damage, No hazard.
PWR_BT1 Pin1 to Pin4	Shorted	240Vac	30min	F1	0.39	Unit operated normally. No damage, No hazard.
PWR_BT1 Pin1 to Pin5	Shorted	240Vac	30min	F1	0.39	Unit operated normally. No damage, No hazard.
PWR_BT1 Pin1 to Pin6	Shorted	240Vac	30min	F1	0.39	Unit operated normally. No damage, No hazard.
Supplementary information:						

<b>C.2</b>	<b>TABLE: transformers</b>						N/A
Loc.	Tested insulation	Working voltage peak / V (2.10.2)	Working voltage rms / V (2.10.2)	Required electric strength (5.2)	Required clearance / mm (2.10.3)	Required creepage distance / mm (2.10.4)	Required distance thr. insul. (2.10.5)
Loc.	Tested insulation			Test voltage / V	Measured clearance / mm	Measured creepage dist. / mm	Measured distance thr. insul. / mm; number of layers
supplementary information:							

<b>C.2</b>	<b>TABLE: transformers</b>						N/A
------------	----------------------------	--	--	--	--	--	-----



### Photo(s)





### Photo(s)





### Photo(s)

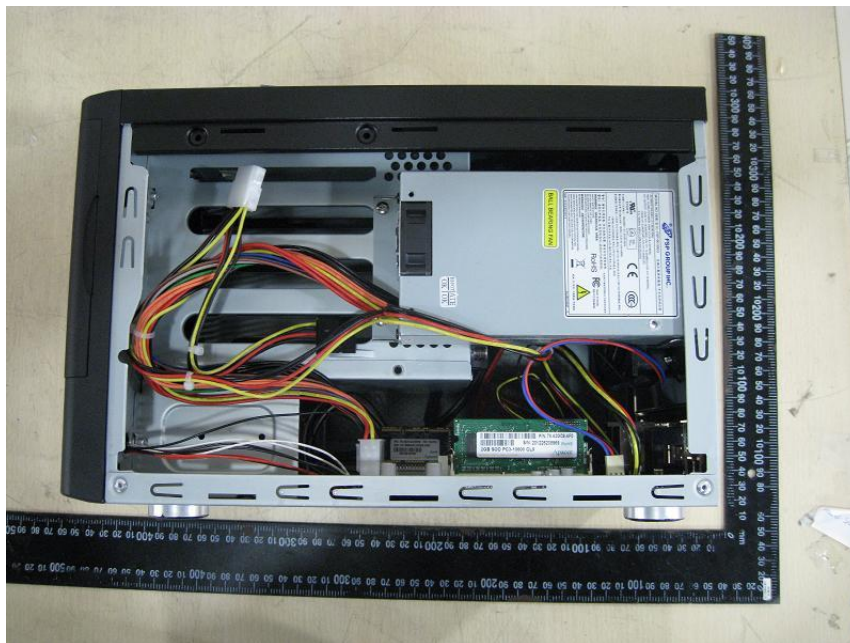



### Photo(s)

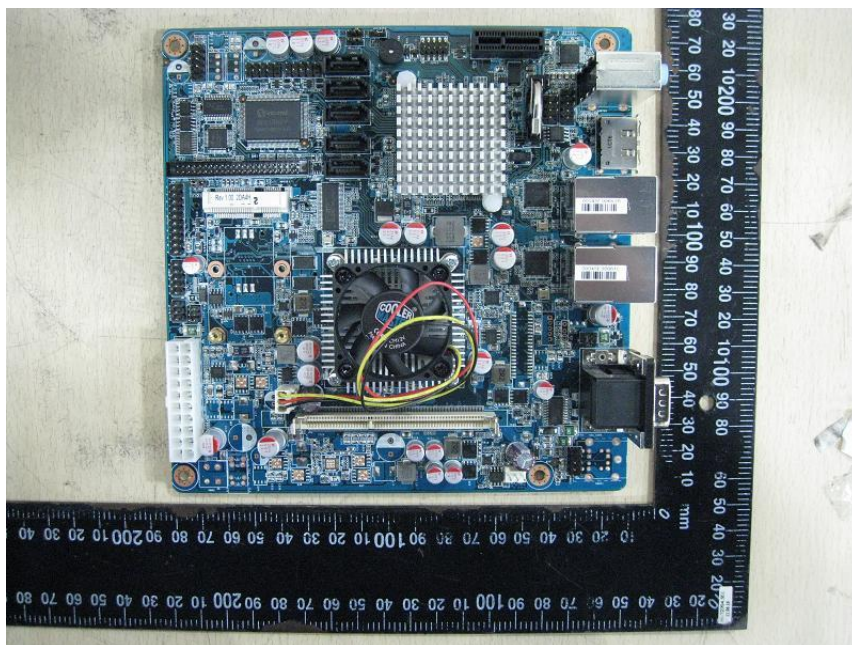



### Photo(s)

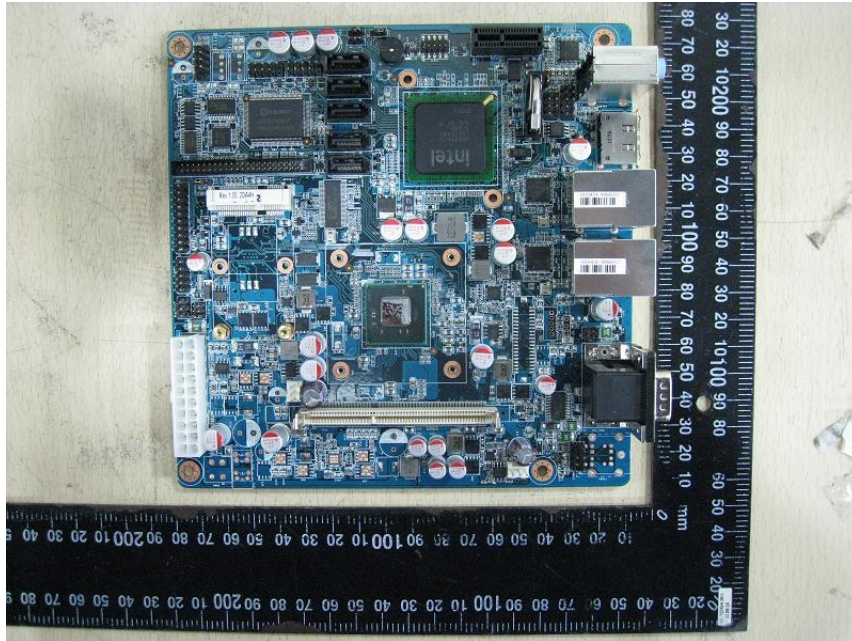





### Photo(s) LED Board

