



CERTIFICATE

Issued Date: Sep. 21, 2012
Report No.: 129088R-ITCEP11V03

This is to certify that the following designated product

Product : Network Camera
Trade name : VIVOTEK
Model Number : IP8172, IP8172P
Company Name : VIVOTEK INC.

This product, which has been issued the test report listed as above in QuieTek Laboratory, is based on a single evaluation of one sample and confirmed to comply with the requirements of the following EMC standard.

EN 55022: 2010, Class A	EN 55024: 2010
EN 61000-3-2: 2006+A2: 2009	IEC 61000-4-2: 2008
EN 61000-3-3: 2008	IEC 61000-4-3: 2010
CISPR 22: 2008	IEC 61000-4-4: 2012
CISPR 24: 2010	IEC 61000-4-5: 2005
AS/NZS CISPR 22: 2009+A1: 2010	IEC 61000-4-6: 2008
	IEC 61000-4-8: 2009
	IEC 61000-4-11: 2004

TEST LABORATORY

Vincent Lin / Manager



Test Report

Product Name : Network Camera

Model No. : IP8172, IP8172P

Applicant : VIVOTEK INC.

Address : 6F, No.192, Lien-Cheng Rd., Chung-Ho,
New Taipei City, 235, Taiwan, R.O.C.

Date of Receipt : 2012/08/31

Issued Date : 2012/09/21

Report No. : 129088R-ITCEP11V03

Report Version : V1.0



The test results relate only to the samples tested.

The test results shown in the test report are traceable to the national/international standard through the calibration of the equipment and evaluated measurement uncertainty herein.

This report must not be used to claim product endorsement by TAF, NVLAP or any agency of the Government.

The test report shall not be reproduced except in full without the written approval of Quietek Corporation.



Declaration of Conformity

We herewith confirm the following designated products to comply with the requirements set out in the Council Directive on the approximation of the laws of the Member States relating to Electromagnetic Compatibility Directive (2004/108/EC) with applicable standards listed below.

Product : Network Camera
Trade name : VIVOTEK
Model Number : IP8172, IP8172P
Applicable Harmonized : EN 55022: 2010, Class A
Standards under Directive 2004/108/EC : EN 55024: 2010
EN 61000-3-2: 2006+A2: 2009
EN 61000-3-3:2008
CISPR 22: 2008
CISPR 24: 2010
AS/NZS CISPR 22: 2009+A1: 2010

Company Name : _____
Company Address : _____
Telephone : _____ Facsimile : _____

Person in responsible for marking this declaration:

_____ Name (Full Name)	_____ Title/ Department
_____ Date	_____ Legal Signature



Statement of Conformity

This statement is to certify that the designated product below.

Product : Network Camera
Trade name : VIVOTEK
Model Number : IP8172, IP8172P
Company Name : VIVOTEK INC.
Applicable Standards : EN 55022: 2010, Class A
EN 55024: 2010
EN 61000-3-2: 2006+A2: 2009
EN 61000-3-3:2008
CISPR 22: 2008
CISPR 24: 2010
AS/NZS CISPR 22: 2009+A1: 2010

One sample of the designated product has been tested and evaluated in our laboratory to find in compliance with the applicable standards above. The issued test report(s) show(s) it in detail.

Report Number : 129088R-ITCEP11V03

TEST LABORATORY



Vincent Lin / Manager

The verification is based on a single evaluation of one sample of above-mentioned products. It does not imply an assessment of the whole production and does not permit the use of the test lab. Logo.

Test Report Certification

Issued Date : 2012/09/21
 Report No. : 129088R-ITCEP11V03



Product Name : Network Camera
 Applicant : VIVOTEK INC.
 Address : 6F, No.192, Lien-Cheng Rd., Chung-Ho, New Taipei City, 235,
 Taiwan, R.O.C.
 Manufacturer : VIVOTEK INC.
 Model No. : IP8172, IP8172P
 EUT Rated Voltage : AC 24V, DC 12V, By POE
 EUT Test Voltage : AC 24V, DC 12V, By POE
 Trade Name : VIVOTEK
 Applicable Standard : EN 55022: 2010, Class A
 EN 55024: 2010
 EN 61000-3-2:2006+A2: 2009
 EN 61000-3-3:2008
 CISPR 22: 2008
 CISPR 24: 2010
 AS/NZS CISPR 22: 2009+A1: 2010
 Test Result : Complied
 Performed Location : Quietek Corporation (Linkou Laboratory)
 No. 5-22, Rueishu Keng, Linkou Dist., New Taipei City 24451,
 Taiwan. R.O.C.
 TEL:+866-2-8601-3788 / FAX:+886-2-8601-3789

Documented By : 
 (Adm. Specialist / Joanne Lin)

Reviewed By : 
 (Assistant Engineer / JoJolee Jung)

Approved By : 
 (Manager / Vincent Lin)

Laboratory Information

We, **QuietTek Corporation**, are an independent EMC and safety consultancy that was established the whole facility in our laboratories. The test facility has been accredited/accepted (audited or listed) by the following related bodies in compliance with ISO 17025, EN 45001 and specified testing scopes:

Taiwan R.O.C.	:	BSMI, NCC, TAF
Norway	:	Nemko, DNV
USA	:	FCC, NVLAP
Japan	:	VCCI

The related certificate for our laboratories about the test site and management system can be downloaded from QuietTek Corporation's Web Site : <http://www.quietek.com/tw/ctg/cts/accreditations.htm>

The address and introduction of QuietTek Corporation's laboratories can be founded in our Web site : <http://www.quietek.com/>

If you have any comments, Please don't hesitate to contact us. Our contact information is as below:

HsinChu Testing Laboratory :

No.75-2, 3rd Lin, Wangye Keng, Yonghxing Tsuen, Qionglin Shiang, Hsinchu County 307, Taiwan, R.O.C.

TEL:+886-3-592-8858 / FAX:+886-3-592-8859

E-Mail : service@quietek.com



Linkou Testing Laboratory :

No. 5-22, Rueishu Keng, Linkou Dist., New Taipei City 24451, Taiwan. R.O.C.

TEL : 886-2-8601-3788 / FAX : 886-2-8601-3789

E-Mail : service@quietek.com



Suzhou (China) Testing Laboratory :

No. 99 Hongye Rd., Suzhou Industrial Park Loufeng Hi-Tech Development Zone., Suzhou, China.

TEL : +86-512-6251-5088 / FAX : +86-512-6251-5098

E-Mail : service@quietek.com

TABLE OF CONTENTS

Description	Page
1. General Information	7
1.1. EUT Description.....	7
1.2. Mode of Operation	8
1.3. Tested System Details	9
1.4. Configuration of Tested System	10
1.5. EUT Exercise Software.....	12
2. Technical Test	13
2.1. Summary of Test Result.....	13
2.2. List of Test Equipment	14
2.3. Measurement Uncertainty.....	16
2.4. Test Environment.....	18
3. Conducted Emission (Main Terminals).....	19
3.1. Test Specification	19
3.2. Test Setup.....	19
3.3. Limit	19
3.4. Test Procedure	20
3.5. Deviation from Test Standard.....	20
3.6. Test Result	21
3.7. Test Photograph	33
4. Conducted Emissions (Telecommunication Ports).....	35
4.1. Test Specification	35
4.2. Test Setup.....	35
4.3. Limit	35
4.4. Test Procedure	36
4.5. Deviation from Test Standard.....	36
4.6. Test Result	37
4.7. Test Photograph	55
5. Radiated Emission	58
5.1. Test Specification	58
5.2. Test Setup.....	58
5.3. Limit	59
5.4. Test Procedure	60
5.5. Deviation from Test Standard.....	60
5.6. Test Result.....	61
5.7. Test Photograph	73
6. Harmonic Current Emission	78

6.1.	Test Specification	78
6.2.	Test Setup.....	78
6.3.	Limit.....	78
6.4.	Test Procedure	80
6.5.	Deviation from Test Standard.....	80
6.6.	Test Result.....	81
6.7.	Test Photograph	85
7.	Voltage Fluctuation and Flicker.....	86
7.1.	Test Specification.....	86
7.2.	Test Setup.....	86
7.3.	Limit.....	86
7.4.	Test Procedure	87
7.5.	Deviation from Test Standard.....	87
7.6.	Test Result.....	88
7.7.	Test Photograph	89
8.	Electrostatic Discharge	91
8.1.	Test Specification.....	91
8.2.	Test Setup.....	91
8.3.	Limit.....	91
8.4.	Test Procedure	92
8.5.	Deviation from Test Standard.....	92
8.6.	Test Result.....	93
8.7.	Test Photograph	96
9.	Radiated Susceptibility	98
9.1.	Test Specification.....	98
9.2.	Test Setup.....	98
9.3.	Limit.....	98
9.4.	Test Procedure	99
9.5.	Deviation from Test Standard.....	99
9.6.	Test Result.....	100
9.7.	Test Photograph	103
10.	Electrical Fast Transient/Burst	112
10.1.	Test Specification.....	112
10.2.	Test Setup.....	112
10.3.	Limit.....	112
10.4.	Test Procedure	113
10.5.	Deviation from Test Standard.....	113
10.6.	Test Result.....	114

10.7.	Test Photograph	117
11.	Surge	120
11.1.	Test Specification	120
11.2.	Test Setup.....	120
11.3.	Limit.....	120
11.4.	Test Procedure	121
11.5.	Deviation from Test Standard.....	121
11.6.	Test Result.....	122
11.7.	Test Photograph	124
12.	Conducted Susceptibility.....	125
12.1.	Test Specification	125
12.2.	Test Setup.....	125
12.3.	Limit.....	126
12.4.	Test Procedure	126
12.5.	Deviation from Test Standard.....	126
12.6.	Test Result.....	127
12.7.	Test Photograph	130
13.	Power Frequency Magnetic Field	133
13.1.	Test Specification	133
13.2.	Test Setup.....	133
13.3.	Limit.....	133
13.4.	Test Procedure	133
13.5.	Deviation from Test Standard.....	133
13.6.	Test Result.....	134
13.7.	Test Photograph	137
14.	Voltage Dips and Interruption.....	139
14.1.	Test Specification	139
14.2.	Test Setup.....	139
14.3.	Limit.....	139
14.4.	Test Procedure	140
14.5.	Deviation from Test Standard.....	140
14.6.	Test Result.....	141
14.7.	Test Photograph	142
15.	Attachment.....	144
	EUT Photograph.....	144

1. General Information

1.1. EUT Description

Product Name	Network Camera
Trade Name	VIVOTEK
Model No.	IP8172, IP8172P

Component	
Power Adapter (1)	MFR: ENG, M/N: 3A-183WP12 Input: AC 100-240V, 50-60Hz, 0.6A Output: DC 12V, 1.5A Cable Out: Non-Shielded, 1.8m
Power Adapter (2) (Optional)	MFR: PTC, M/N: N/A Input: AC 110/220V Output: AC 24V Cable IN: Non-Shielded, 1m Cable Out: Non-Shielded, 1m

Note: The different of the each model is shown as below:

Model No.	Description
IP8172	DC IRIS
IP8172P	P IRIS
Note: DC IRIS and P IRIS are LENS is dissimilar	

1.2. Mode of Operation

Quietek has verified the construction and function in typical operation. All the test modes were carried out with the EUT in normal operation, which was shown in this test report and defined as:

Pre-Test Mode	
Mode 1: AC 24V Mode 2: DC 12V Mode 3: PoE	
Final Test Mode	
Conducted Emission	Mode 1: AC 24V Mode 2: DC 12V
Impedance Stabilization Network	Mode 1: AC 24V
Radiated Emission	Mode 2: DC 12V Mode 3: PoE
Power Harmonics	
Voltage Fluctuation and Flicker	Mode 1: AC 24V
Surge	Mode 2: DC 12V
Voltage dips and interruption	
Electrostatic Discharge	
Radiated susceptibility	Mode 1: AC 24V
Electrical fast transient/burst	Mode 2: DC 12V
Conducted susceptibility	Mode 3: PoE
Power frequency magnetic field	

1.3. Tested System Details

The types for all equipments, plus descriptions of all cables used in the tested system (including inserted cards) are:

Test Mode		Mode 1, Mode 2			
Product		Manufacturer	Model No.	Serial No.	Power Cord
1	Monitor(EMI)	SONY	PVM-14M2U	2105742	Non-Shielded, 1.8m
	Monitor(EMS)	SONY	LMDV 1410	N/A	Non-Shielded, 1.8m
2	Microphone & Earphone	Ergotech	ET-E201	N/A	N/A
3	SD Card (2GB)	Transcend	TS2GSDC	256987 7612	N/A
4	Notebook PC	DELL	PP04X	C8YYM1S	Non-Shielded, 1.8m

Test Mode		Mode 3			
Product		Manufacturer	Model No.	Serial No.	Power Cord
1	Monitor(EMI)	SONY	PVM-14M2U	2105742	Non-Shielded, 1.8m
	Monitor(EMS)	SONY	LMDV 1410	N/A	Non-Shielded, 1.8m
2	Microphone & Earphone	Ergotech	ET-E201	N/A	N/A
3	SD Card 2GB	Transcend	TS2GSDC	256987 7612	N/A
4	PoE	VIVOTEK	IJ-1748NDN	N/A	Non-Shielded, 1.8m
5	Notebook PC	DELL	PP04X	C8YYM1S	Non-Shielded, 1.8m

1.4. Configuration of Tested System

Test Mode	Mode 1, Mode 2	
Connection Diagram		
<p>The diagram illustrates the configuration of the tested system. A central box labeled 'EUT' contains an 'SD Card (3)'. To the left, a 'Monitor (1)' is connected to the EUT by a line labeled 'A'. Below the EUT, a 'Microphone & Earphone (2)' is connected to the EUT by a line labeled 'C'. To the right, a 'Notebook PC (4)' is connected to the EUT by a line labeled 'B'. A dashed rectangular box encloses the Monitor (1), SD Card (3), EUT, and Microphone & Earphone (2).</p>		
Signal Cable Type		Signal cable Description
A	Coaxial Cable	Shielded, 3m
B	LAN Cable	Non-Shielded, 3m
C	Microphone & Earphone Cable	Non-Shielded, 1.6m

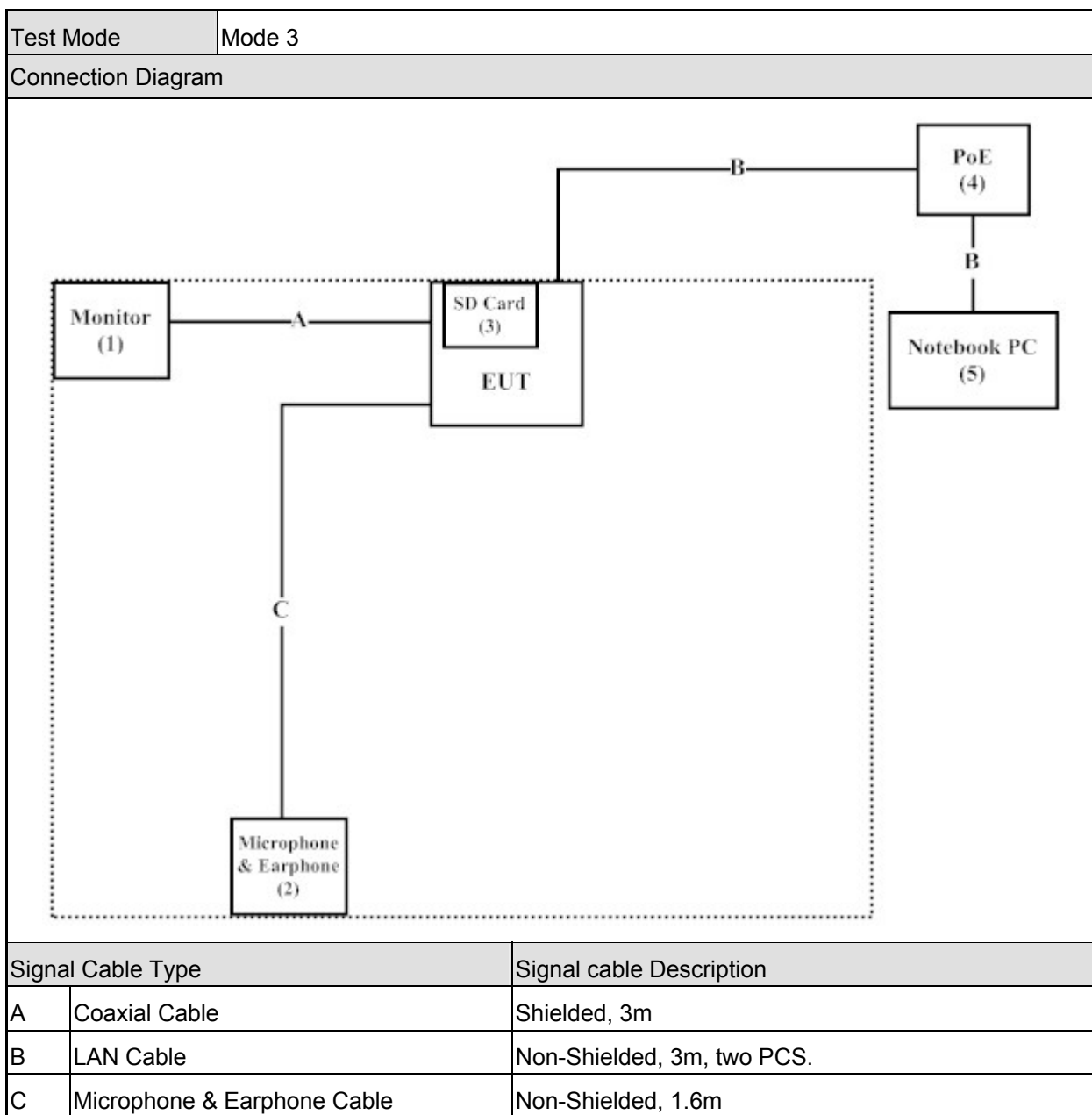

1.5. EUT Exercise Software

1	Setup the EUT and simulators as shown on 1.4.
2	Turn on the power of all equipment.
3	The EUT will start to operate and display the video figure from the signal source.
4	The EUT will display “video figure” on monitor.
5	SD Card works while the EUT is recording.
6	Repeat the above procedure (3) to (5).

2. Technical Test

2.1. Summary of Test Result

- No deviations from the test standards
 Deviations from the test standards as below description:

Emission			
Performed Item	Normative References	Test Performed	Deviation
Conducted Emission	EN 55022: 2010 AS/NZS CISPR 22: 2009+A1: 2010	Yes	No
Impedance Stabilization Network	EN 55022: 2010 AS/NZS CISPR 22: 2009+A1: 2010	Yes	No
Radiated Emission	EN 55022: 2010 AS/NZS CISPR 22: 2009+A1: 2010	Yes	No
Power Harmonics	EN 61000-3-2:2006+A2: 2009	Yes	No
Voltage Fluctuation and Flicker	EN 61000-3-3:2008	Yes	No

Immunity			
Performed Item	Normative References	Test Performed	Deviation
Electrostatic Discharge	IEC 61000-4-2: 2008	Yes	No
Radiated susceptibility	IEC 61000-4-3: 2010	Yes	No
Electrical fast transient/burst	IEC 61000-4-4: 2012	Yes	No
Surge	IEC 61000-4-5: 2005	Yes	No
Conducted susceptibility	IEC 61000-4-6: 2008	Yes	No
Power frequency magnetic field	IEC 61000-4-8: 2009	Yes	No
Voltage dips and interruption	IEC 61000-4-11: 2004	Yes	No

2.2. List of Test Equipment

Conducted Emission / SR1

Instrument	Manufacturer	Type No.	Serial No	Cal. Date
EMI Test Receiver	R&S	ESCS 30	838251/001	2012/06/05
LISN	R&S	ESH3-Z5	836679/023	2012/01/12
LISN	R&S	ENV216	100085	2012/02/13
Pulse Limiter	R&S	ESH3-Z2	357.8810.52-1	2012/09/16

Impedance Stabilization Network / SR1

Instrument	Manufacturer	Type No.	Serial No	Cal. Date
Capacitive Voltage Probe	Schaffner	CVP2200A	18331	2011/11/23
EMI Test Receiver	R&S	ESCS 30	838251/001	2012/06/05
LISN	R&S	ENV216	100085	2012/02/13
LISN	R&S	ESH3-Z5	836679/023	2012/01/12
Pulse Limiter	R&S	ESH3-Z2	357.8810.52-1	2012/09/16
RF Current Probe	FCC	F-65 10KHz~1GHz	198	2011/10/25
BALANCED TELECOM ISN	FCC	FCC-TLISN-T2-02	20316	2012/07/22
Impedance Stabilization Network	Teseq	ISN T800	30303	2012/03/10

Radiated Emission / Site 7

Instrument	Manufacturer	Type No.	Serial No	Cal. Date
EMI Test Receiver	R&S	ESCI	100648	2011/10/13
Bilog Antenna	Schaffner Chase	CBL6112B	2930	2012/07/06
Pre-Amplifier	QTK	AP-025C	071919	2012/07/07
Site7 NSA	QTK	N/A	N/A	2012/06/27

Radiated Emission / CB7

Instrument	Manufacturer	Type No.	Serial No	Cal. Date
EMI Test Receiver	Agilent	E4440A	MY46185846	2011/12/12
Horn Antenna	ETS-Lindgren	3117	00135205	2012/03/30
Horn Antenna	SCHWARZBECK	9120D	576	2011/11/14
Pre-Amplifier	Quietek	AP-180C	CHM/071920	2012/07/12
CB7 VSWR	QTK	N/A	N/A	2012/08/25

Power Harmonics / SR3

Instrument	Manufacturer	Type No.	Serial No	Cal. Date
AC Power Source(Harmonic)	Schaffner	NSG 1007	HK54148	2012/09/13
IEC1000-4-X Analyzer(Flicker)	Schaffner	CCN 1000-1	X7 1887	2012/09/13

Voltage Fluctuation and Flicker / SR3

Instrument	Manufacturer	Type No.	Serial No	Cal. Date
AC Power Source(Harmonic)	Schaffner	NSG 1007	HK54148	2012/09/13
IEC1000-4-X Analyzer(Flicker)	Schaffner	CCN 1000-1	X7 1887	2012/09/13

Electrostatic Discharge / SR6

Instrument	Manufacturer	Type No.	Serial No	Cal. Date
ESD Simulator System	Noiseken	TC-815R	ESS0929097	2012/06/21
Horizontal Coupling Plane(HCP)	Quietek	HCP AL50	N/A	N/A
Vertical Coupling Plane(VCP)	Quietek	VCP AL50	N/A	N/A

Radiated susceptibility / CB5

Instrument	Manufacturer	Type No.	Serial No	Cal. Date
AF-BOX	R&S	AF-BOX ACCUST	100007	N/A
Audio Analyzer	R&S	UPL 16	100137	2012/05/15
Biconilog Antenna	EMCO	3149	00071675	N/A
Directional Coupler	A&R	DC 6180	22735	N/A
Power Amplifier	A&R	30S1G3	309453	N/A
Power Amplifier	A&R	100W10000M7	A285000010	N/A
Power Amplifier	SCHAFFNER	CBA9413B	4020	N/A
Power Amplifier	AR	75A250A	0325371	N/A
Power Meter	R&S	NRVD(P.M)	100219	2012/05/18
Pre-Amplifier	A&R	150A220	23067	N/A
Signal Generator	R&S	SMT03	100170	2012/05/16

Electrical fast transient/burst / SR3

Instrument	Manufacturer	Type No.	Serial No	Cal. Date
TRANSIENT TEST SYSTEM	EMC PARTNER	TRA2000IN6	1138	2011/11/30

Surge / SR3

Instrument	Manufacturer	Type No.	Serial No	Cal. Date
TRANSIENT TEST SYSTEM	EMC PARTNER	TRA2000IN6	1138	2011/11/30

Conducted susceptibility / SR6

Instrument	Manufacturer	Type No.	Serial No	Cal. Date
TESEQ RF-Generator	TESEQ	NSG 4070A-30	032847	2012/08/08

Power frequency magnetic field / SR3

Instrument	Manufacturer	Type No.	Serial No	Cal. Date
Induction Coil Interface	Schaffner	INA 2141	6002	N/A
Magnetic Loop Coil	Schaffner	INA 702	160	N/A

Voltage dips and interruption / SR3

Instrument	Manufacturer	Type No.	Serial No	Cal. Date
TRANSIENT TEST SYSTEM	EMC PARTNER	TRA2000IN6	1138	2011/11/30

2.3. Measurement Uncertainty

Conducted Emission

The measurement uncertainty is evaluated as ± 2.26 dB.

Impedance Stabilization Network

The measurement uncertainty is evaluated as ± 2.26 dB.

Radiated Emission

The measurement uncertainty is evaluated as ± 3.19 dB.

Harmonic Current Emission

The measurement uncertainty is evaluated as 4.7 (mA/A).

Voltage Fluctuation and Flicker

The measurement uncertainty is evaluated as 0.27 (mV/V).

Electrostatic Discharge

As what is concluded in the document from Note2 of clause 5.4.6.2 of ISO/IEC 17025, the requirements for measurement uncertainty in ESD testing are deemed to have been satisfied, and the testing is reported in accordance with the relevant ESD standards. The immunity test signal from the ESD system meet the required specifications in IEC 61000-4-2 through the calibration report with the calibrated uncertainty for the waveform of voltage and timing as being 3.0 % and 3.8%.

Radiated susceptibility

As what is concluded in the document from Note2 of clause 5.4.6.2 of ISO/IEC 17025, the requirements for measurement uncertainty in RS testing are deemed to have been satisfied, and the testing is reported in accordance with the relevant RS standards. The immunity test signal from the RS system meet the required specifications in IEC 61000-4-3 through the calibration for the uniform field strength and monitoring for the test level with the uncertainty evaluation report for the electrical field strength as being 3.57 dB.

Electrical fast transient/burst

As what is concluded in the document from Note2 of clause 5.4.6.2 of ISO/IEC 17025, the requirements for measurement uncertainty in EFT/Burst testing are deemed to have been satisfied, and the testing is reported in accordance with the relevant EFT/Burst standards. The immunity test signal from the EFT/Burst system meet the required specifications in IEC 61000-4-4 through the calibration report with the calibrated uncertainty for the waveform of voltage, frequency and timing as being 4 %, and 2.5%.

Surge

As what is concluded in the document from Note2 of clause 5.4.6.2 of ISO/IEC 17025, the requirements for measurement uncertainty in Surge testing are deemed to have been satisfied, and the testing is reported in accordance with the relevant Surge standards. The immunity test signal from the Surge system meet the required specifications in IEC 61000-4-5 through the calibration report with the calibrated uncertainty for the waveform of voltage and timing as being 3.5 % and 0.1%.

Conducted susceptibility

As what is concluded in the document from Note2 of clause 5.4.6.2 of ISO/IEC 17025, the requirements for measurement uncertainty in CS testing are deemed to have been satisfied, and the testing is reported in accordance with the relevant CS standards. The immunity test signal from the CS system meet the required specifications in IEC 61000-4-6 through the calibration for unmodulated signal and monitoring for the test level with the uncertainty evaluation report for the injected modulated signal level through CDN and EM Clamp/Direct Injection as being 2.0 dB and 2.61 dB.

Power frequency magnetic field

As what is concluded in the document from Note2 of clause 5.4.6.2 of ISO/IEC 17025, the requirements for measurement uncertainty in PFM testing are deemed to have been satisfied, and the testing is reported in accordance with the relevant PFM standards. The immunity test signal from the PFM system meet the required specifications in IEC 61000-4-8 through the calibration report with the calibrated uncertainty for the Gauss Meter to verify the output level of magnetic field strength as being 2.0 %.

Voltage dips and interruption

As what is concluded in the document from Note2 of clause 5.4.6.2 of ISO/IEC 17025, the requirements for measurement uncertainty in DIP testing are deemed to have been satisfied, and the testing is reported in accordance with the relevant DIP standards. The immunity test signal from the DIP system meet the required specifications in IEC 61000-4-11 through the calibration report with the calibrated uncertainty for the waveform of voltage and timing as being 3.5 % and 0.1%.

2.4. Test Environment

Performed Item	Items	Required	Actual
Conducted Emission	Temperature (°C)	15-35	25.5
	Humidity (%RH)	25-75	53
	Barometric pressure (mbar)	860-1060	950-1000
Impedance Stabilization Network	Temperature (°C)	15-35	25.5
	Humidity (%RH)	25-75	53
	Barometric pressure (mbar)	860-1060	950-1000
Radiated Emission	Temperature (°C)	15-35	25.8
	Humidity (%RH)	25-75	58
	Barometric pressure (mbar)	860-1060	950-1000
Electrostatic Discharge	Temperature (°C)	15-35	20
	Humidity (%RH)	30-60	51
	Barometric pressure (mbar)	860-1060	950-1000
Radiated susceptibility	Temperature (°C)	15-35	21
	Humidity (%RH)	25-75	52
	Barometric pressure (mbar)	860-1060	950-1000
Electrical fast transient/burst	Temperature (°C)	15-35	21
	Humidity (%RH)	25-75	52
	Barometric pressure (mbar)	860-1060	950-1000
Surge	Temperature (°C)	15-35	21
	Humidity (%RH)	10-75	52
	Barometric pressure (mbar)	860-1060	950-1000
Conducted susceptibility	Temperature (°C)	15-35	22
	Humidity (%RH)	25-75	52
	Barometric pressure (mbar)	860-1060	950-1000
Power frequency magnetic field	Temperature (°C)	15-35	21
	Humidity (%RH)	25-75	52
	Barometric pressure (mbar)	860-1060	950-1000
Voltage dips and interruption	Temperature (°C)	15-35	21
	Humidity (%RH)	25-75	53
	Barometric pressure (mbar)	860-1060	950-1000

3. Conducted Emission (Main Terminals)

3.1. Test Specification

According to EMC Standard : EN 55022 and AS/NZS CISPR 22

3.2. Test Setup

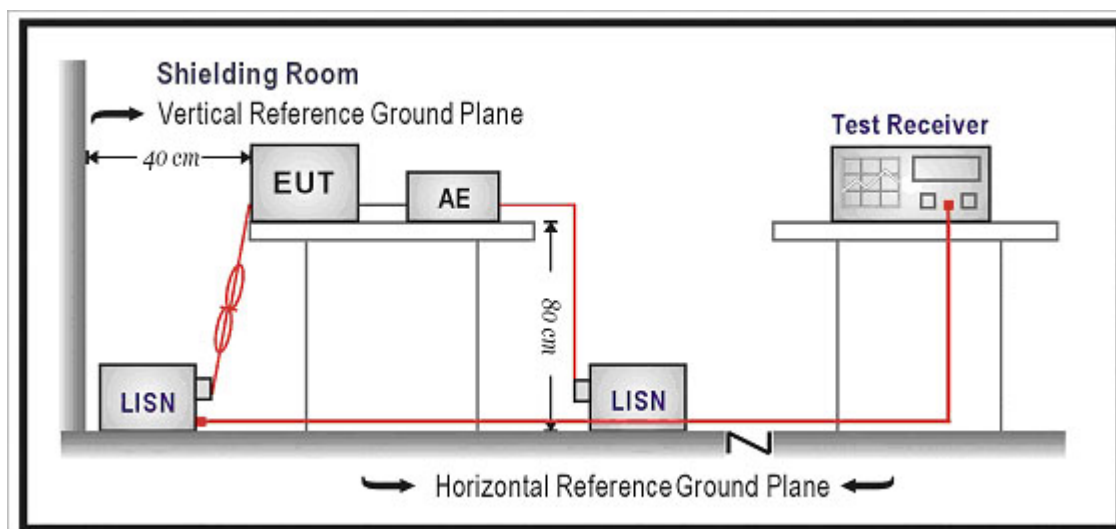

3.3. Limit

Limits		
Frequency (MHz)	QP (dBuV)	AV (dBuV)
0.15 - 0.50	79	66
0.50-5.0	73	60
5.0 - 30	73	60

Remarks: In the above table, the tighter limit applies at the band edges.

3.4. Test Procedure

The EUT and simulators are connected to the main power through a line impedance stabilization network (L.I.S.N.). This provides a 50 ohm /50uH coupling impedance for the measuring equipment. The peripheral devices are also connected to the main power through a LISN that provides a 50ohm/50uH coupling impedance with 50ohm termination.

(Please refers to the block diagram of the test setup and photographs.)

Both sides of A.C. line are checked for maximum conducted interference. In order to find the maximum emission, the relative positions of equipment and all of the interface cables must be changed on conducted measurement.

Conducted emissions were invested over the frequency range from 0.15MHz to 30MHz using a receiver bandwidth of 9kHz.

3.5. Deviation from Test Standard

No deviation.

3.6. Test Result

Site : SR1	Time : 2012/09/05 - 00:40
Limit : CISPR_A_00M_QP	Margin : 10
EUT : Network Camera	Probe : ENV_216_L1 - Line1
Power : AC 230V/50Hz to AC 24V	Note : Mode 1

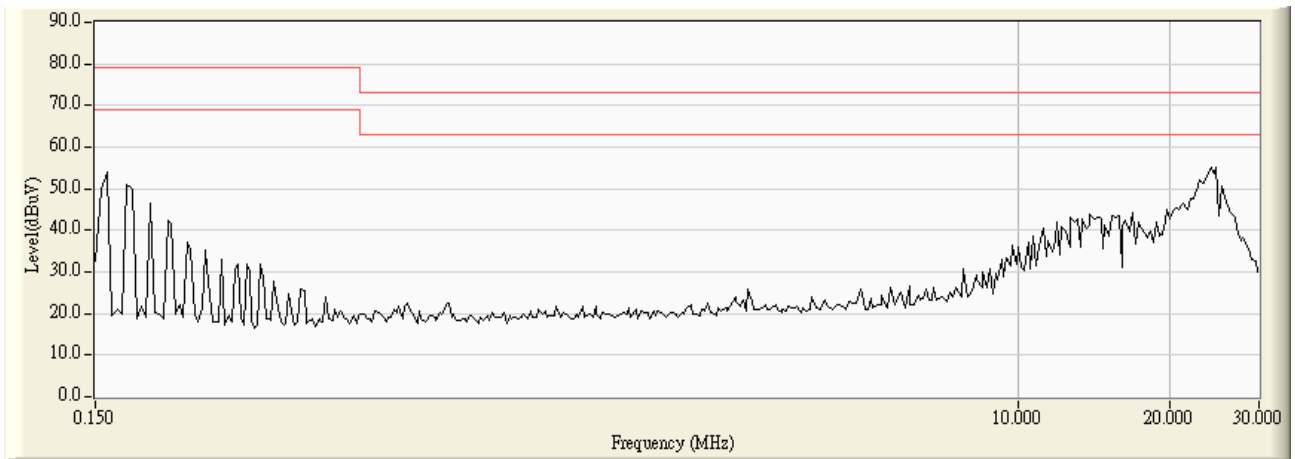

Site : SR1	Time : 2012/09/05 - 00:42
Limit : CISPR_A_00M_QP	Margin : 0
EUT : Network Camera	Probe : ENV_216_L1 - Line1
Power : AC 230V/50Hz to AC 24V	Note : Mode 1

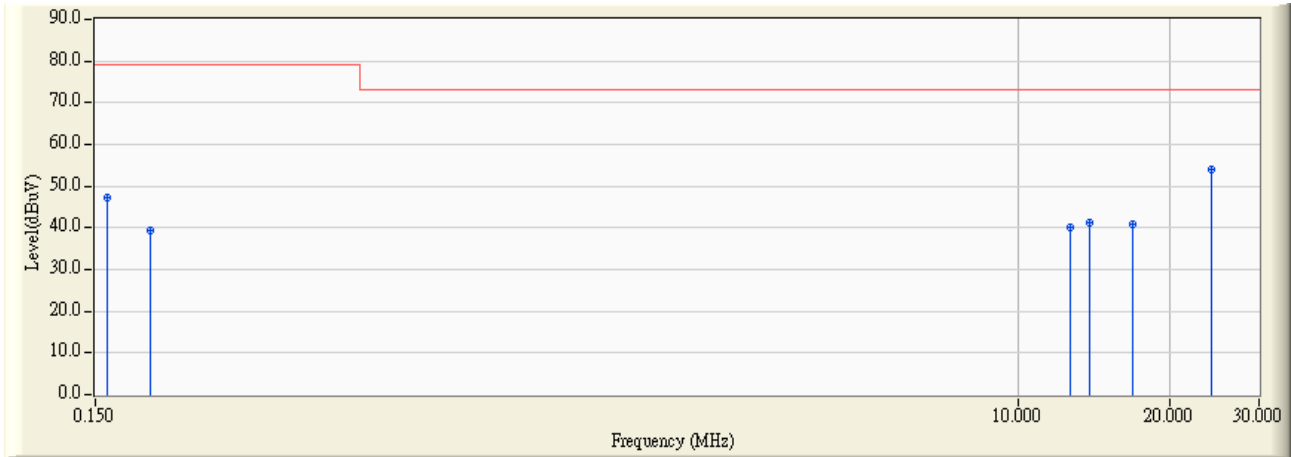

		Frequency (MHz)	Correct Factor (dB)	Reading Level (dBuV)	Measure Level (dBuV)	Margin (dB)	Limit (dBuV)	Detector Type
1		0.158	9.821	37.520	47.341	-31.659	79.000	QUASPEAK
2		0.193	9.821	29.670	39.491	-39.509	79.000	QUASPEAK
3		12.693	10.020	30.220	40.240	-32.760	73.000	QUASPEAK
4		13.916	10.023	31.130	41.153	-31.847	73.000	QUASPEAK
5		16.845	10.056	30.690	40.746	-32.254	73.000	QUASPEAK
6	*	24.170	10.140	43.900	54.040	-18.960	73.000	QUASPEAK

Note:

1. All Reading Levels are Quasi-Peak and average value.
2. " * ", means this data is the worst emission level.
3. Measurement Level = Reading Level + Correct Factor

Site : SR1	Time : 2012/09/05 - 00:42
Limit : CISPR_A_00M_AV	Margin : 0
EUT : Network Camera	Probe : ENV_216_L1 - Line1
Power : AC 230V/50Hz to AC 24V	Note : Mode 1



		Frequency (MHz)	Correct Factor (dB)	Reading Level (dBuV)	Measure Level (dBuV)	Margin (dB)	Limit (dBuV)	Detector Type
1		0.158	9.821	7.850	17.671	-48.329	66.000	AVERAGE
2		0.193	9.821	2.060	11.881	-54.119	66.000	AVERAGE
3		12.693	10.020	22.910	32.930	-27.070	60.000	AVERAGE
4		13.916	10.023	23.990	34.013	-25.987	60.000	AVERAGE
5		16.845	10.056	24.410	34.466	-25.534	60.000	AVERAGE
6	*	24.170	10.140	38.730	48.870	-11.130	60.000	AVERAGE

Note:

1. All Reading Levels are Quasi-Peak and average value.
2. " * ", means this data is the worst emission level.
3. Measurement Level = Reading Level + Correct Factor

Site : SR1	Time : 2012/09/05 - 00:42
Limit : CISPR_A_00M_QP	Margin : 10
EUT : Network Camera	Probe : ENV_216_N - Line2
Power : AC 230V/50Hz to AC 24V	Note : Mode 1

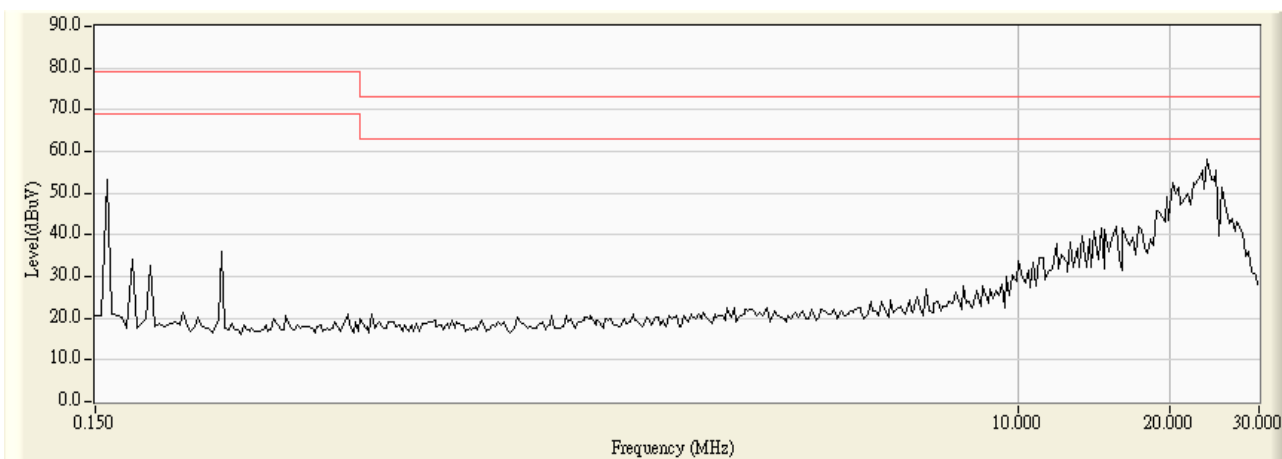

Site : SR1	Time : 2012/09/05 - 00:44
Limit : CISPR_A_00M_QP	Margin : 0
EUT : Network Camera	Probe : ENV_216_N - Line2
Power : AC 230V/50Hz to AC 24V	Note : Mode 1

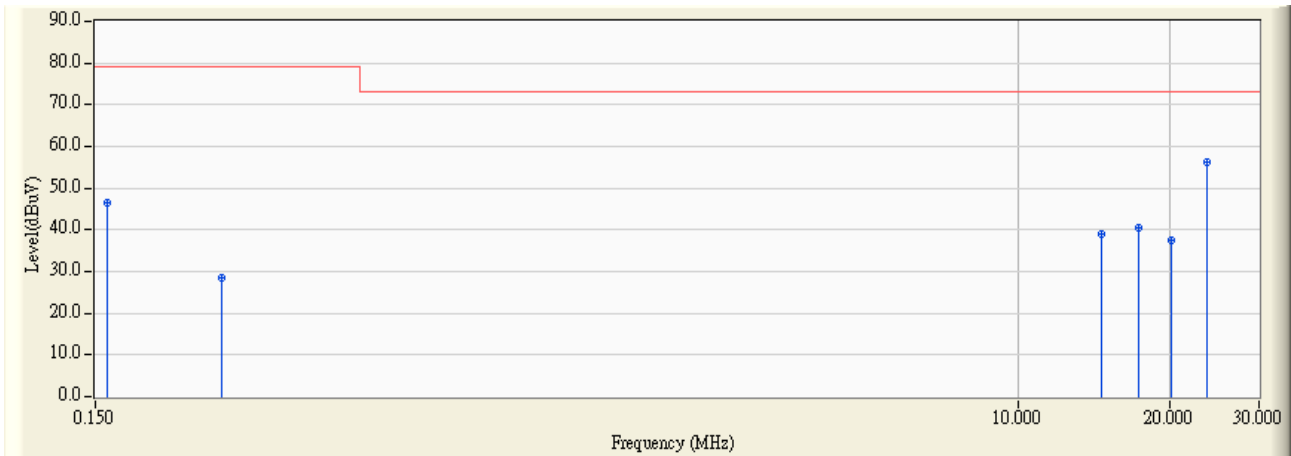

		Frequency (MHz)	Correct Factor (dB)	Reading Level (dBuV)	Measure Level (dBuV)	Margin (dB)	Limit (dBuV)	Detector Type
1		0.158	9.861	36.600	46.461	-32.539	79.000	QUASIPeAK
2		0.267	9.861	18.530	28.391	-50.609	79.000	QUASIPeAK
3		14.646	10.127	28.870	38.997	-34.003	73.000	QUASIPeAK
4		17.334	10.195	30.130	40.325	-32.675	73.000	QUASIPeAK
5		20.091	10.280	27.310	37.590	-35.410	73.000	QUASIPeAK
6	*	23.681	10.310	45.790	56.100	-16.900	73.000	QUASIPeAK

Note:

1. All Reading Levels are Quasi-Peak and average value.
2. " * ", means this data is the worst emission level.
3. Measurement Level = Reading Level + Correct Factor

Site : SR1	Time : 2012/09/05 - 00:44
Limit : CISPR_A_00M_AV	Margin : 0
EUT : Network Camera	Probe : ENV_216_N - Line2
Power : AC 230V/50Hz to AC 24V	Note : Mode 1



		Frequency (MHz)	Correct Factor (dB)	Reading Level (dBuV)	Measure Level (dBuV)	Margin (dB)	Limit (dBuV)	Detector Type
1		0.158	9.861	7.140	17.001	-48.999	66.000	AVERAGE
2		0.267	9.861	-3.110	6.751	-59.249	66.000	AVERAGE
3		14.646	10.127	22.460	32.587	-27.413	60.000	AVERAGE
4		17.334	10.195	24.210	34.405	-25.595	60.000	AVERAGE
5		20.091	10.280	17.500	27.780	-32.220	60.000	AVERAGE
6	*	23.681	10.310	40.590	50.900	-9.100	60.000	AVERAGE

Note:

1. All Reading Levels are Quasi-Peak and average value.
2. " * ", means this data is the worst emission level.
3. Measurement Level = Reading Level + Correct Factor

Site : SR1	Time : 2012/09/04 - 23:52
Limit : CISPR_A_00M_QP	Margin : 10
EUT : Network Camera	Probe : ENV_216_L1 - Line1
Power : AC 230V/50Hz to DC 12V	Note : Mode 2

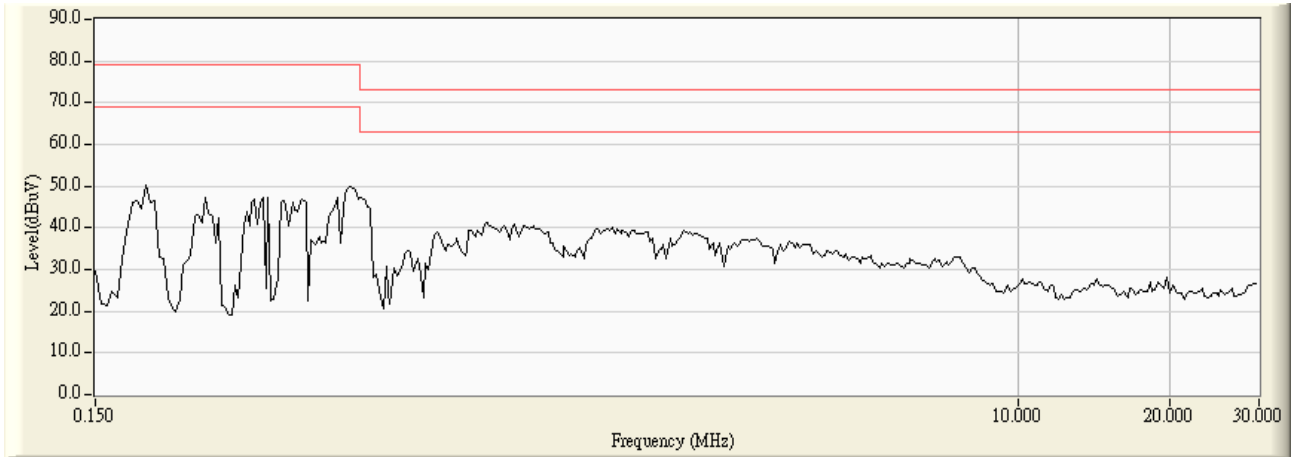

Site : SR1	Time : 2012/09/04 - 23:53
Limit : CISPR_A_00M_QP	Margin : 0
EUT : Network Camera	Probe : ENV_216_L1 - Line1
Power : AC 230V/50Hz to DC 12V	Note : Mode 2

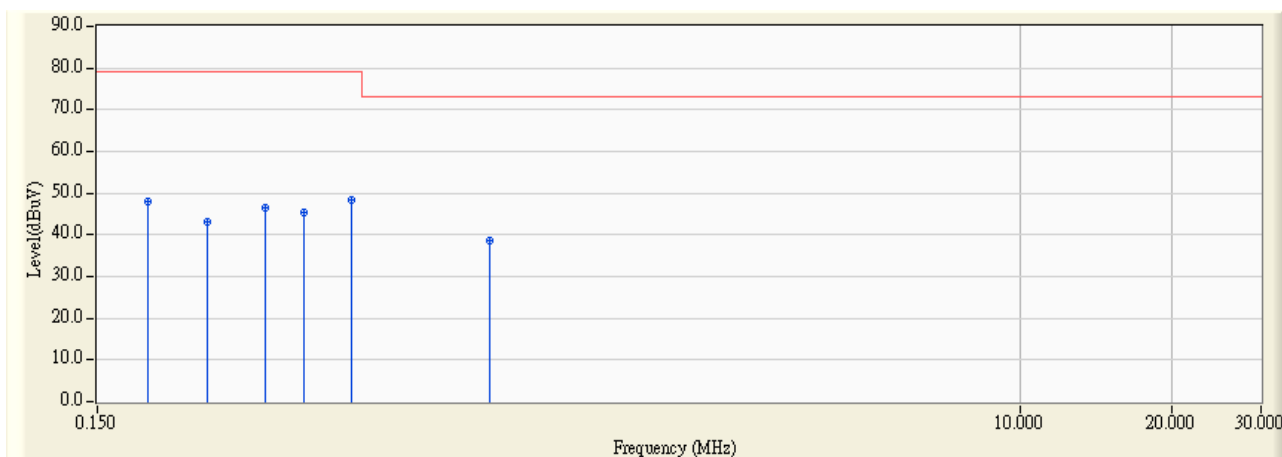

		Frequency (MHz)	Correct Factor (dB)	Reading Level (dBuV)	Measure Level (dBuV)	Margin (dB)	Limit (dBuV)	Detector Type
1		0.189	9.821	38.070	47.891	-31.109	79.000	QUASIPeAK
2		0.248	9.821	33.380	43.201	-35.799	79.000	QUASIPeAK
3		0.323	9.821	36.620	46.441	-32.559	79.000	QUASIPeAK
4		0.384	9.822	35.510	45.332	-33.668	79.000	QUASIPeAK
5	*	0.478	9.822	38.490	48.312	-30.688	79.000	QUASIPeAK
6		0.896	9.824	28.980	38.804	-34.196	73.000	QUASIPeAK

Note:

1. All Reading Levels are Quasi-Peak and average value.
2. " * ", means this data is the worst emission level.
3. Measurement Level = Reading Level + Correct Factor

Site : SR1	Time : 2012/09/04 - 23:53
Limit : CISPR_A_00M_AV	Margin : 0
EUT : Network Camera	Probe : ENV_216_L1 - Line1
Power : AC 230V/50Hz to DC 12V	Note : Mode 2

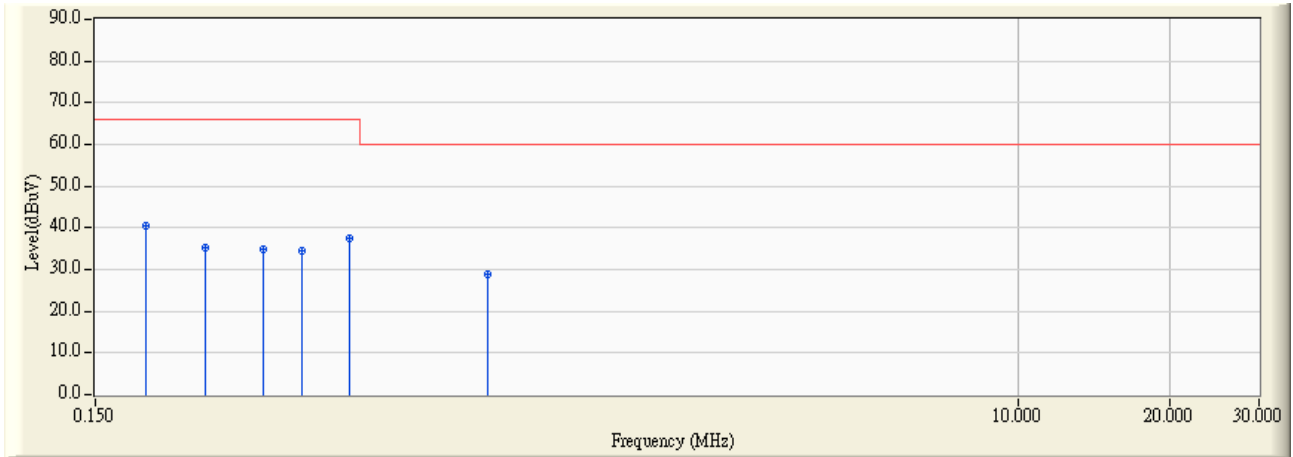

		Frequency (MHz)	Correct Factor (dB)	Reading Level (dBuV)	Measure Level (dBuV)	Margin (dB)	Limit (dBuV)	Detector Type
1	*	0.189	9.821	30.560	40.381	-25.619	66.000	AVERAGE
2		0.248	9.821	25.480	35.301	-30.699	66.000	AVERAGE
3		0.323	9.821	25.010	34.831	-31.169	66.000	AVERAGE
4		0.384	9.822	24.720	34.542	-31.458	66.000	AVERAGE
5		0.478	9.822	27.670	37.492	-28.508	66.000	AVERAGE
6		0.896	9.824	19.080	28.904	-31.096	60.000	AVERAGE

Note:

1. All Reading Levels are Quasi-Peak and average value.
2. " * ", means this data is the worst emission level.
3. Measurement Level = Reading Level + Correct Factor

Site : SR1	Time : 2012/09/04 - 23:54
Limit : CISPR_A_00M_QP	Margin : 10
EUT : Network Camera	Probe : ENV_216_N - Line2
Power : AC 230V/50Hz to DC 12V	Note : Mode 2

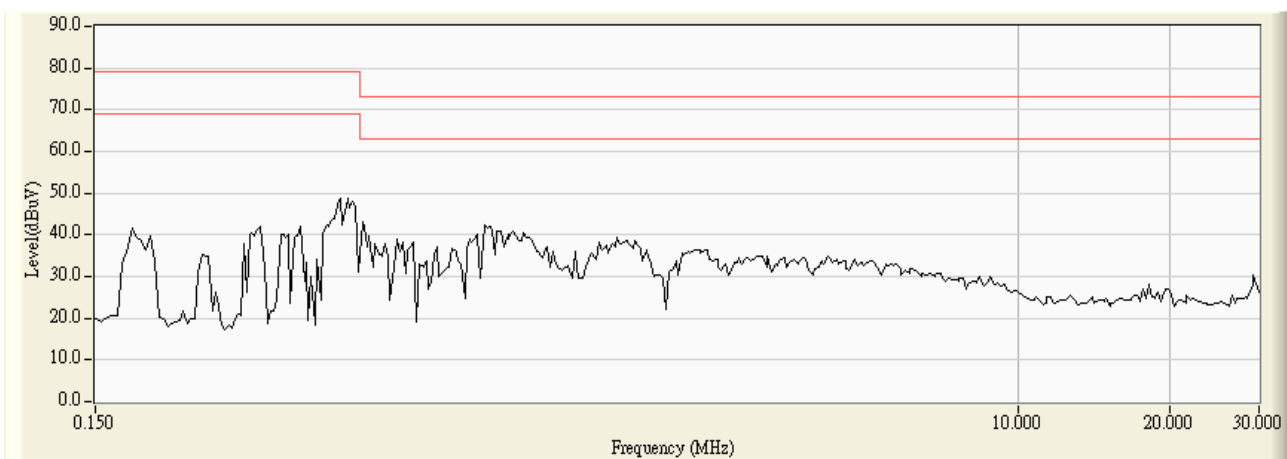

Site : SR1	Time : 2012/09/04 - 23:55
Limit : CISPR_A_00M_QP	Margin : 0
EUT : Network Camera	Probe : ENV_216_N - Line2
Power : AC 230V/50Hz to DC 12V	Note : Mode 2

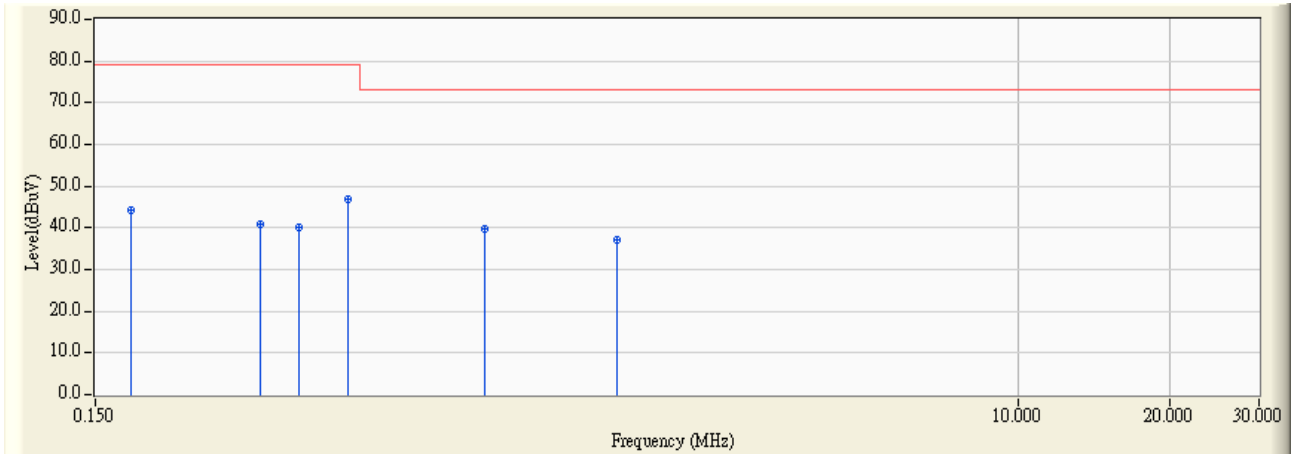

		Frequency (MHz)	Correct Factor (dB)	Reading Level (dBuV)	Measure Level (dBuV)	Margin (dB)	Limit (dBuV)	Detector Type
1		0.177	9.861	34.280	44.141	-34.859	79.000	QUASIPeAK
2		0.318	9.871	30.970	40.841	-38.159	79.000	QUASIPeAK
3		0.380	9.872	30.090	39.962	-39.038	79.000	QUASIPeAK
4	*	0.474	9.872	37.100	46.972	-32.028	79.000	QUASIPeAK
5		0.884	9.874	29.970	39.844	-33.156	73.000	QUASIPeAK
6		1.611	9.887	27.130	37.017	-35.983	73.000	QUASIPeAK

Note:

1. All Reading Levels are Quasi-Peak and average value.
2. " * ", means this data is the worst emission level.
3. Measurement Level = Reading Level + Correct Factor

Site : SR1	Time : 2012/09/04 - 23:55
Limit : CISPR_A_00M_AV	Margin : 0
EUT : Network Camera	Probe : ENV_216_N - Line2
Power : AC 230V/50Hz to DC 12V	Note : Mode 2

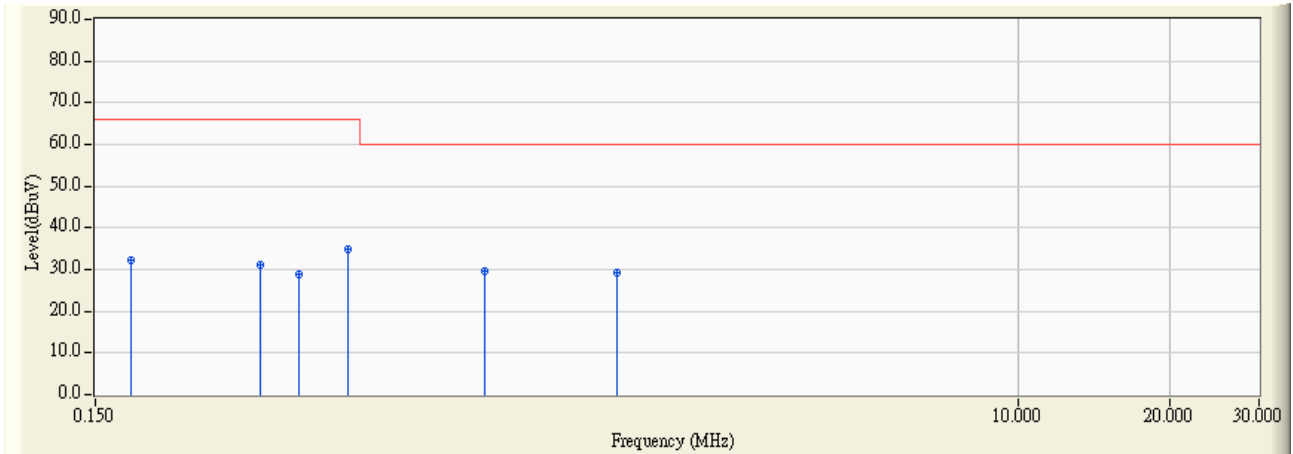

		Frequency (MHz)	Correct Factor (dB)	Reading Level (dBuV)	Measure Level (dBuV)	Margin (dB)	Limit (dBuV)	Detector Type
1		0.177	9.861	22.300	32.161	-33.839	66.000	AVERAGE
2		0.318	9.871	21.280	31.151	-34.849	66.000	AVERAGE
3		0.380	9.872	19.160	29.032	-36.968	66.000	AVERAGE
4		0.474	9.872	25.090	34.962	-31.038	66.000	AVERAGE
5	*	0.884	9.874	19.710	29.584	-30.416	60.000	AVERAGE
6		1.611	9.887	19.270	29.157	-30.843	60.000	AVERAGE

Note:

1. All Reading Levels are Quasi-Peak and average value.
2. " * ", means this data is the worst emission level.
3. Measurement Level = Reading Level + Correct Factor

3.7. Test Photograph

Test Mode : Mode 1: AC 24V

Description : Front View of Conducted Test



Test Mode : Mode 1: AC 24V

Description : Back View of Conducted Test



Test Mode : Mode 2: DC 12V

Description : Front View of Conducted Test



Test Mode : Mode 2: DC 12V

Description : Back View of Conducted Test



4. Conducted Emissions (Telecommunication Ports)

4.1. Test Specification

According to EMC Standard : EN 55022 and AS/NZS CISPR 22

4.2. Test Setup

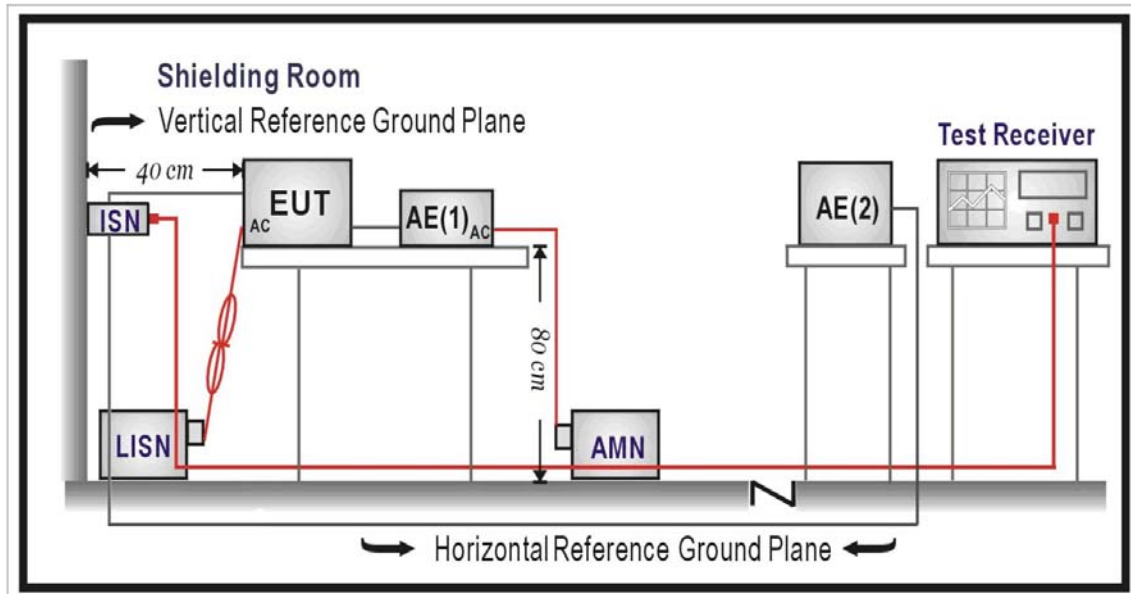

4.3. Limit

Limits		
Frequency (MHz)	QP (dBuV)	AV (dBuV)
0.15 - 0.50	97 – 87	84 – 74
0.50 - 30	87	74

Remarks:

The limit decreases linearly with the logarithm of the frequency in the range 0.15 MHz~0.50 MHz.

4.4. Test Procedure

Telecommunication Port:

The mains voltage shall be supplied to the EUT via the LISN when the measurement of telecommunication port is performed. The common mode disturbances at the telecommunication port shall be connected to the ISN, which is 150 ohm impedance.

Both alternative cables are tested related to the LCL requested. The measurement range is from 150kHz to 30MHz. The bandwidth of measurement is set to 9kHz.

The 75dB LCL ISN is used for cat. 6 cable, the 65dB LCL ISN is used for cat. 5 cable, 55dB LCL ISN is used for cat. 3.

4.5. Deviation from Test Standard

No deviation.

4.6. Test Result

Site : SR1	Time : 2012/09/05 - 00:49
Limit : ISN_Voltage_A_00M_QP	Margin : 10
EUT : Network Camera	Probe : TESEQ_T8 - Line1
Power : AC 230V/50Hz to AC 24V	Note : Mode 1, ISN 10Mbps

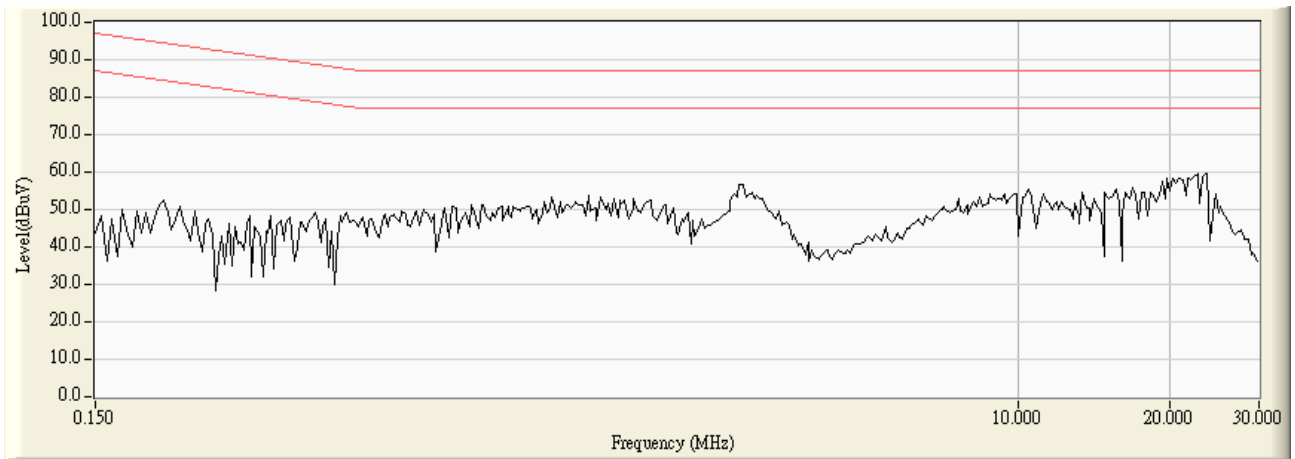

Site : SR1	Time : 2012/09/05 - 00:50
Limit : ISN_Voltage_A_00M_QP	Margin : 0
EUT : Network Camera	Probe : TESEQ_T8 - Line1
Power : AC 230V/50Hz to AC 24V	Note : Mode 1, ISN 10Mbps

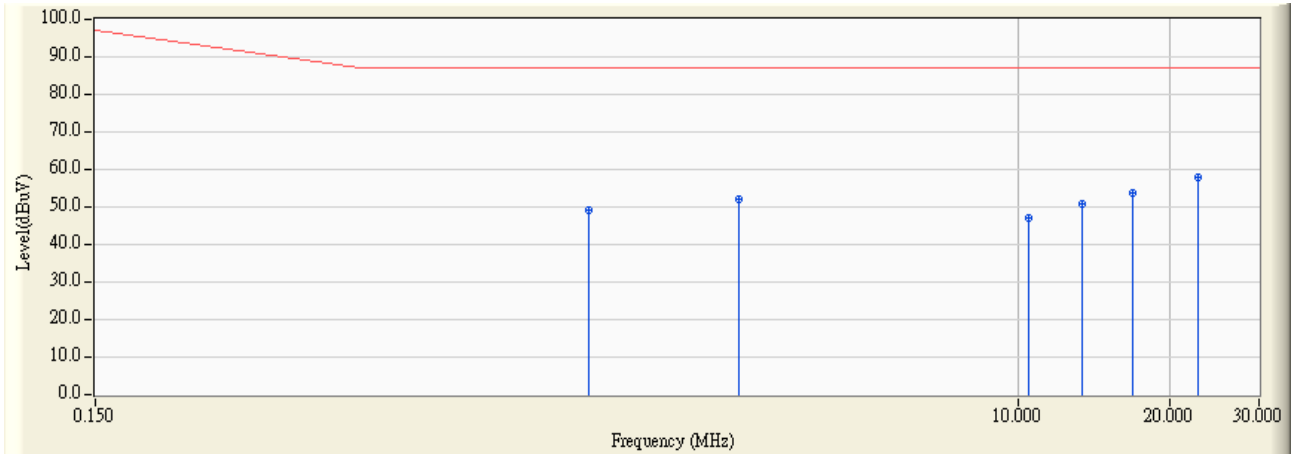

		Frequency (MHz)	Correct Factor (dB)	Reading Level (dBuV)	Measure Level (dBuV)	Margin (dB)	Limit (dBuV)	Detector Type
1		1.420	9.916	39.140	49.056	-37.944	87.000	QUASIPeAK
2		2.806	9.889	42.340	52.229	-34.771	87.000	QUASIPeAK
3		10.505	9.910	37.100	47.010	-39.990	87.000	QUASIPeAK
4		13.427	9.921	40.830	50.751	-36.249	87.000	QUASIPeAK
5		16.845	9.976	43.780	53.756	-33.244	87.000	QUASIPeAK
6	*	22.705	10.130	47.610	57.740	-29.260	87.000	QUASIPeAK

Note:

1. All Reading Levels are Quasi-Peak and average value.
2. " * ", means this data is the worst emission level.
3. Measurement Level = Reading Level + Correct Factor

Site : SR1	Time : 2012/09/05 - 00:50
Limit : ISN_Voltage_A_00M_AV	Margin : 0
EUT : Network Camera	Probe : TESEQ_T8 - Line1
Power : AC 230V/50Hz to AC 24V	Note : Mode 1, ISN 10Mbps

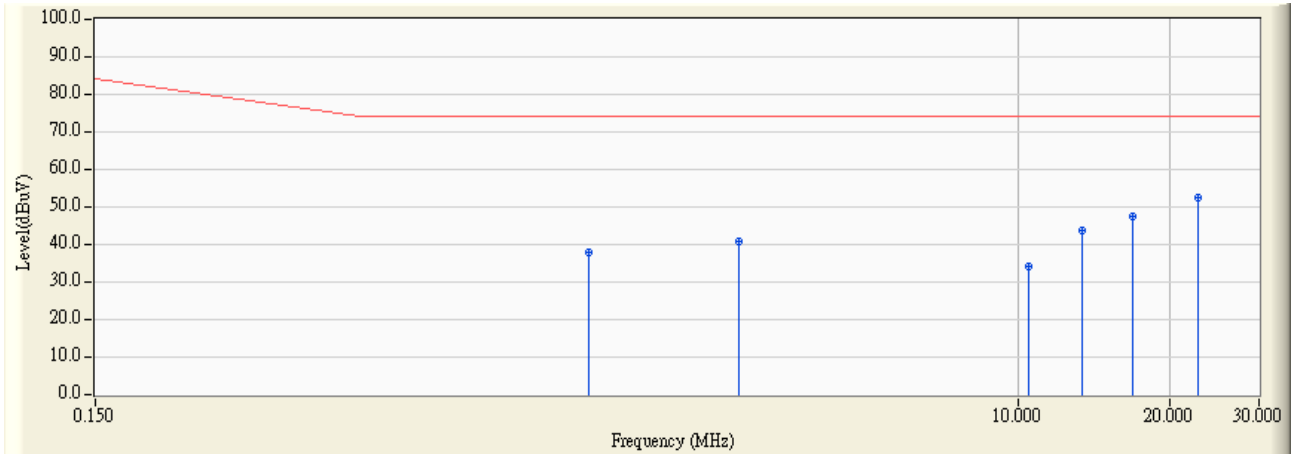

		Frequency (MHz)	Correct Factor (dB)	Reading Level (dBuV)	Measure Level (dBuV)	Margin (dB)	Limit (dBuV)	Detector Type
1		1.420	9.916	28.150	38.066	-35.934	74.000	AVERAGE
2		2.806	9.889	30.870	40.759	-33.241	74.000	AVERAGE
3		10.505	9.910	24.170	34.080	-39.920	74.000	AVERAGE
4		13.427	9.921	33.780	43.701	-30.299	74.000	AVERAGE
5		16.845	9.976	37.560	47.536	-26.464	74.000	AVERAGE
6	*	22.705	10.130	42.280	52.410	-21.590	74.000	AVERAGE

Note:

1. All Reading Levels are Quasi-Peak and average value.
2. " * ", means this data is the worst emission level.
3. Measurement Level = Reading Level + Correct Factor

Site : SR1	Time : 2012/09/05 - 00:51
Limit : ISN_Voltage_A_00M_QP	Margin : 10
EUT : Network Camera	Probe : TESEQ_T8 - Line1
Power : AC 230V/50Hz to AC 24V	Note : Mode 1, ISN 100Mbps

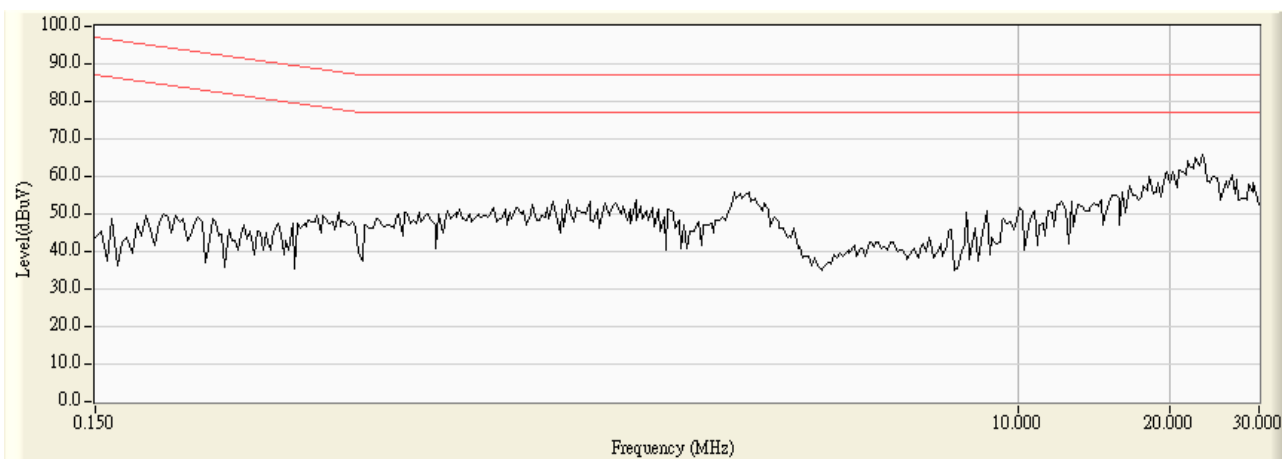

Site : SR1	Time : 2012/09/05 - 00:53
Limit : ISN_Voltage_A_00M_QP	Margin : 0
EUT : Network Camera	Probe : TESEQ_T8 - Line1
Power : AC 230V/50Hz to AC 24V	Note : Mode 1, ISN 100Mbps

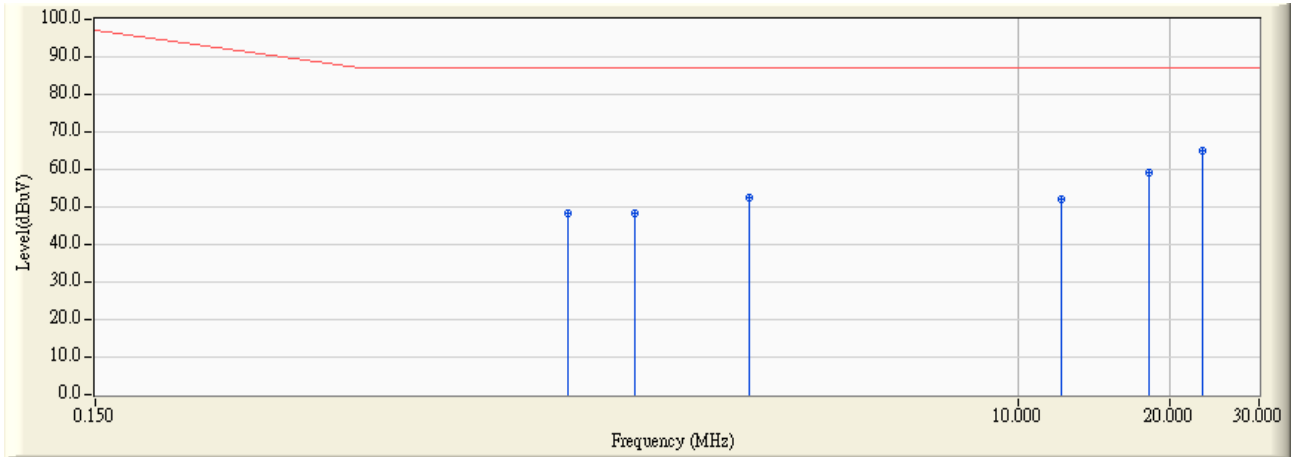

		Frequency (MHz)	Correct Factor (dB)	Reading Level (dBuV)	Measure Level (dBuV)	Margin (dB)	Limit (dBuV)	Detector Type
1		1.291	9.926	38.550	48.476	-38.524	87.000	QUASIPeAK
2		1.755	9.898	38.560	48.458	-38.542	87.000	QUASIPeAK
3		2.939	9.883	42.700	52.583	-34.417	87.000	QUASIPeAK
4		12.201	9.910	42.100	52.010	-34.990	87.000	QUASIPeAK
5		18.244	10.024	49.040	59.064	-27.936	87.000	QUASIPeAK
6	*	23.130	10.140	55.000	65.140	-21.860	87.000	QUASIPeAK

Note:

1. All Reading Levels are Quasi-Peak and average value.
2. " * ", means this data is the worst emission level.
3. Measurement Level = Reading Level + Correct Factor

Site : SR1	Time : 2012/09/05 - 00:53
Limit : ISN_Voltage_A_00M_AV	Margin : 0
EUT : Network Camera	Probe : TESEQ_T8 - Line1
Power : AC 230V/50Hz to AC 24V	Note : Mode 1, ISN 100Mbps

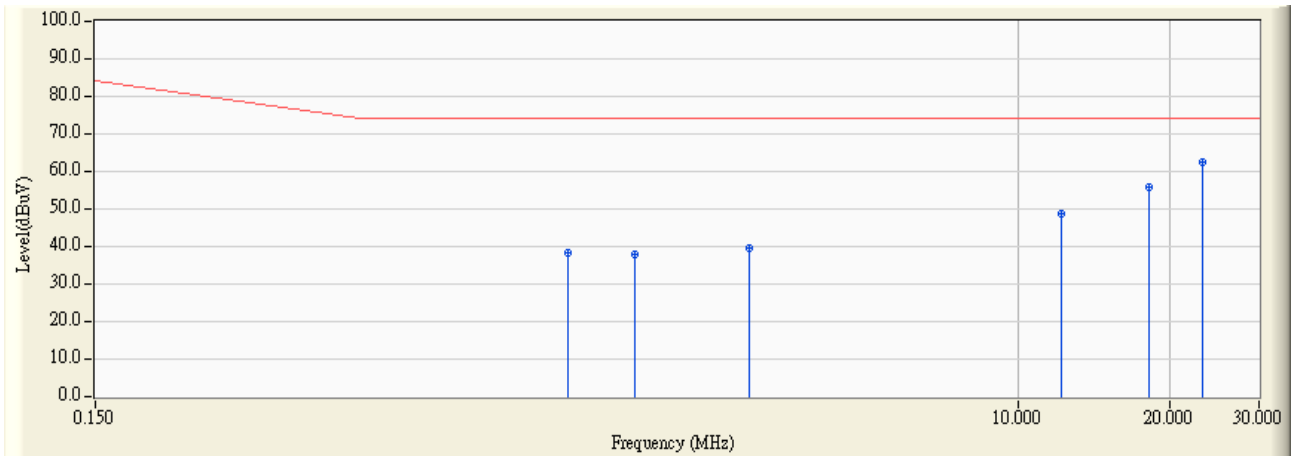

		Frequency (MHz)	Correct Factor (dB)	Reading Level (dBuV)	Measure Level (dBuV)	Margin (dB)	Limit (dBuV)	Detector Type
1		1.291	9.926	28.420	38.346	-35.654	74.000	AVERAGE
2		1.755	9.898	28.060	37.958	-36.042	74.000	AVERAGE
3		2.939	9.883	29.880	39.763	-34.237	74.000	AVERAGE
4		12.201	9.910	38.920	48.830	-25.170	74.000	AVERAGE
5		18.244	10.024	45.900	55.924	-18.076	74.000	AVERAGE
6	*	23.130	10.140	52.550	62.690	-11.310	74.000	AVERAGE

Note:

1. All Reading Levels are Quasi-Peak and average value.
2. " * ", means this data is the worst emission level.
3. Measurement Level = Reading Level + Correct Factor

Site : SR1	Time : 2012/09/04 - 23:47
Limit : ISN_Voltage_A_00M_QP	Margin : 10
EUT : Network Camera	Probe : TESEQ_T8 - Line1
Power : AC 230V/50Hz to DC 12V	Note : Mode 2, ISN 10Mbps

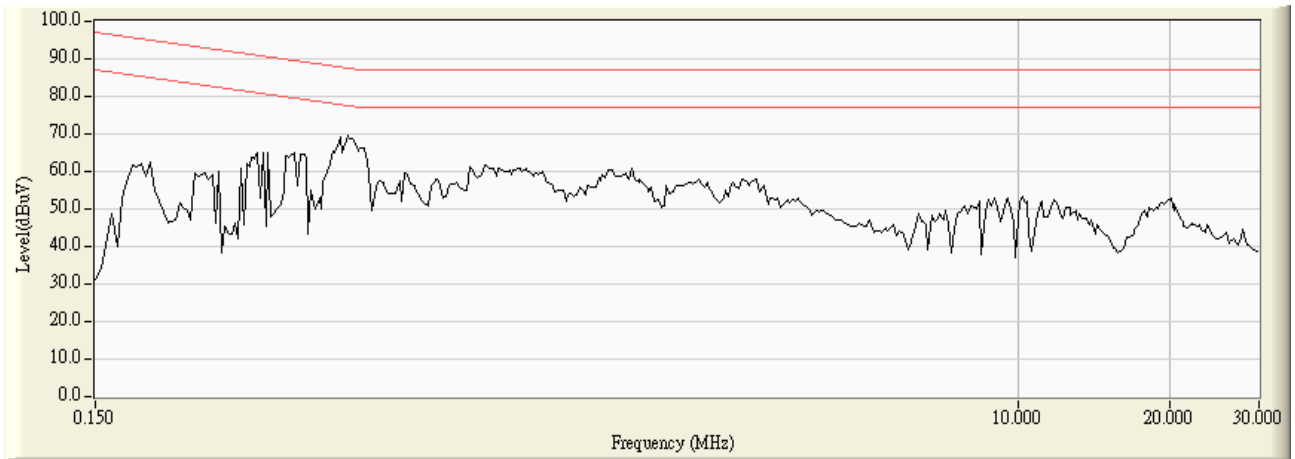

Site : SR1	Time : 2012/09/04 - 23:48
Limit : ISN_Voltage_A_00M_QP	Margin : 0
EUT : Network Camera	Probe : TESEQ_T8 - Line1
Power : AC 230V/50Hz to DC 12V	Note : Mode 2, ISN 10Mbps

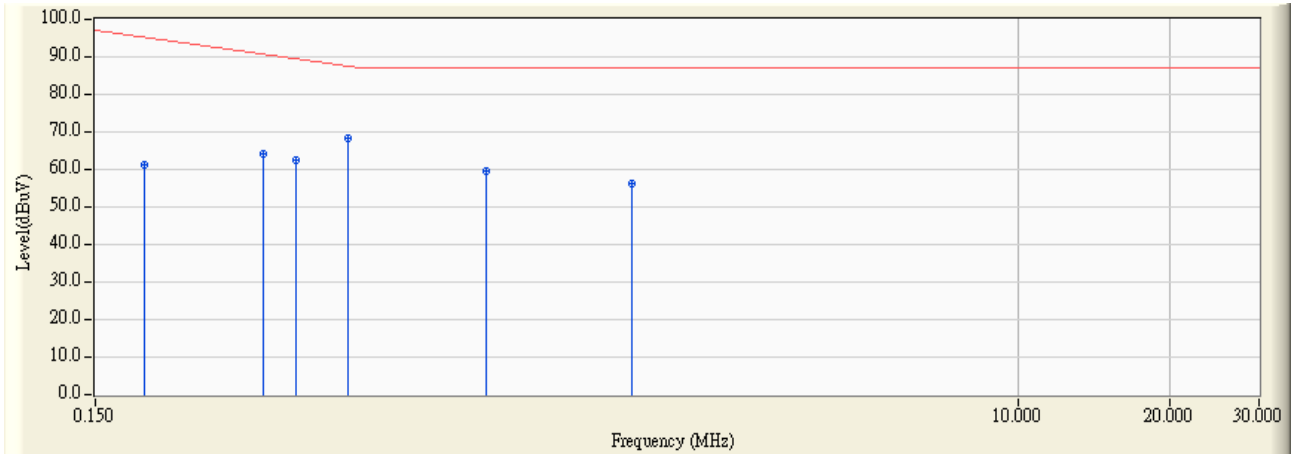

		Frequency (MHz)	Correct Factor (dB)	Reading Level (dBuV)	Measure Level (dBuV)	Margin (dB)	Limit (dBuV)	Detector Type
1		0.188	10.339	50.830	61.169	-34.745	95.914	QUASIPeAK
2		0.323	10.187	53.850	64.037	-28.020	92.057	QUASIPeAK
3		0.373	10.148	52.440	62.588	-28.041	90.629	QUASIPeAK
4	*	0.474	10.065	58.200	68.265	-19.478	87.743	QUASIPeAK
5		0.888	9.967	49.660	59.627	-27.373	87.000	QUASIPeAK
6		1.728	9.898	46.270	56.168	-30.832	87.000	QUASIPeAK

Note:

1. All Reading Levels are Quasi-Peak and average value.
2. " * ", means this data is the worst emission level.
3. Measurement Level = Reading Level + Correct Factor

Site : SR1	Time : 2012/09/04 - 23:48
Limit : ISN_Voltage_A_00M_AV	Margin : 0
EUT : Network Camera	Probe : TESEQ_T8 - Line1
Power : AC 230V/50Hz to DC 12V	Note : Mode 2, ISN 10Mbps

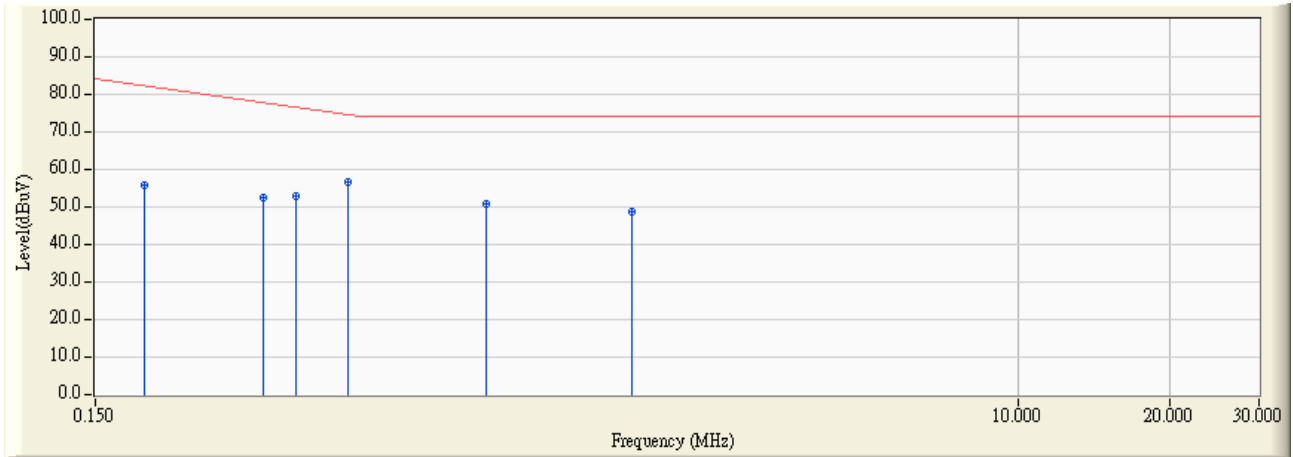

		Frequency (MHz)	Correct Factor (dB)	Reading Level (dBuV)	Measure Level (dBuV)	Margin (dB)	Limit (dBuV)	Detector Type
1		0.188	10.339	45.440	55.779	-27.135	82.914	AVERAGE
2		0.323	10.187	42.390	52.577	-26.480	79.057	AVERAGE
3		0.373	10.148	42.870	53.018	-24.611	77.629	AVERAGE
4	*	0.474	10.065	46.480	56.545	-18.198	74.743	AVERAGE
5		0.888	9.967	40.800	50.767	-23.233	74.000	AVERAGE
6		1.728	9.898	38.650	48.548	-25.452	74.000	AVERAGE

Note:

1. All Reading Levels are Quasi-Peak and average value.
2. " * ", means this data is the worst emission level.
3. Measurement Level = Reading Level + Correct Factor

Site : SR1	Time : 2012/09/04 - 23:50
Limit : ISN_Voltage_A_00M_QP	Margin : 10
EUT : Network Camera	Probe : TESEQ_T8 - Line1
Power : AC 230V/50Hz to DC 12V	Note : Mode 2, ISN 100Mbps

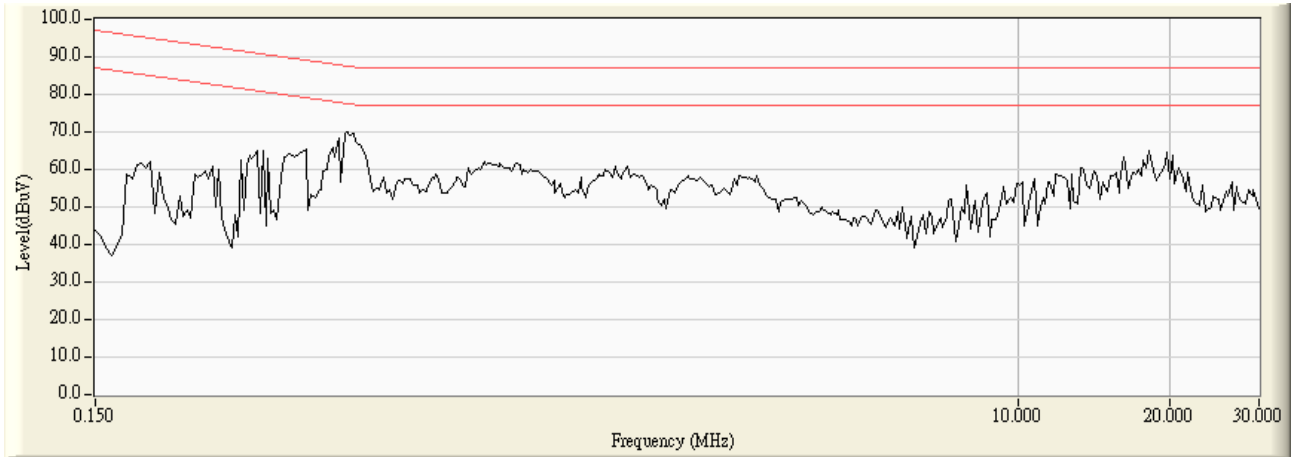

Site : SR1	Time : 2012/09/04 - 23:51
Limit : ISN_Voltage_A_00M_QP	Margin : 0
EUT : Network Camera	Probe : TESEQ_T8 - Line1
Power : AC 230V/50Hz to DC 12V	Note : Mode 2, ISN 100Mbps

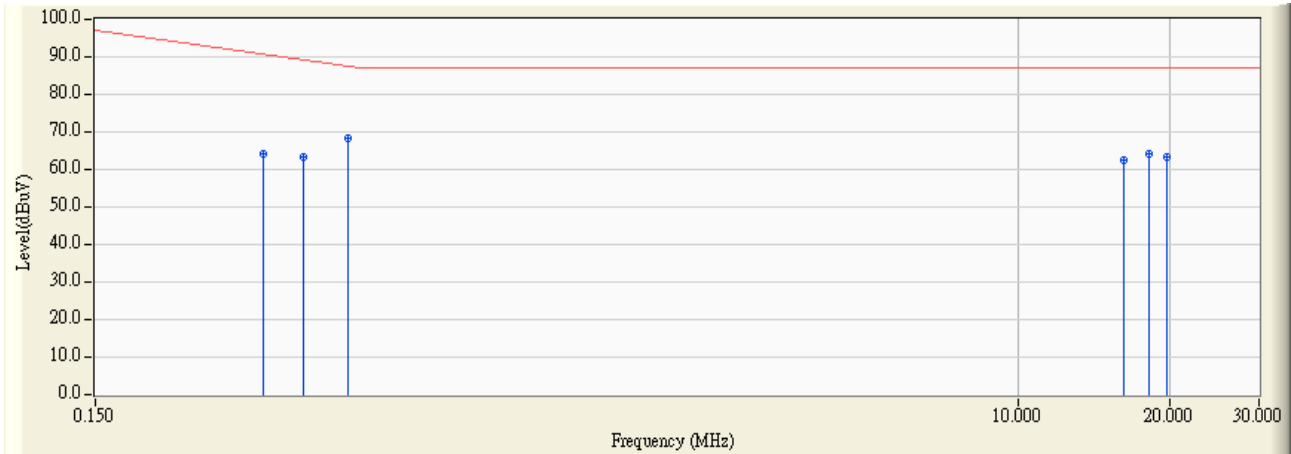

		Frequency (MHz)	Correct Factor (dB)	Reading Level (dBuV)	Measure Level (dBuV)	Margin (dB)	Limit (dBuV)	Detector Type
1		0.322	10.188	53.930	64.119	-27.967	92.086	QUASIPeAK
2		0.388	10.132	53.290	63.422	-26.778	90.200	QUASIPeAK
3	*	0.474	10.065	58.280	68.345	-19.398	87.743	QUASIPeAK
4		16.228	9.955	52.660	62.615	-24.385	87.000	QUASIPeAK
5		18.244	10.024	54.040	64.064	-22.936	87.000	QUASIPeAK
6		19.709	10.078	53.260	63.338	-23.662	87.000	QUASIPeAK

Note:

1. All Reading Levels are Quasi-Peak and average value.
2. " * ", means this data is the worst emission level.
3. Measurement Level = Reading Level + Correct Factor

Site : SR1	Time : 2012/09/04 - 23:51
Limit : ISN_Voltage_A_00M_AV	Margin : 0
EUT : Network Camera	Probe : TESEQ_T8 - Line1
Power : AC 230V/50Hz to DC 12V	Note : Mode 2, ISN 100Mbps

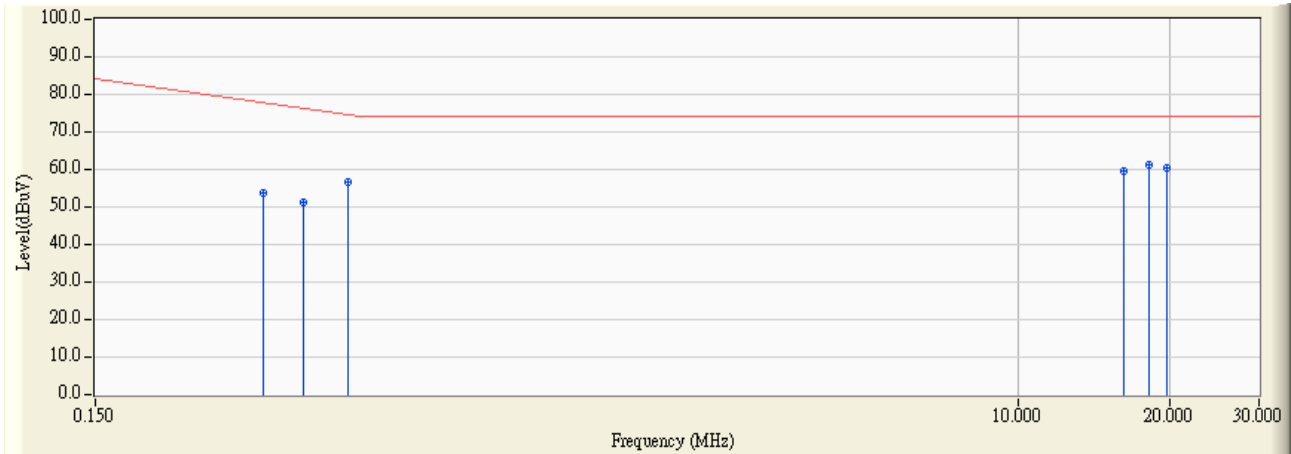

		Frequency (MHz)	Correct Factor (dB)	Reading Level (dBuV)	Measure Level (dBuV)	Margin (dB)	Limit (dBuV)	Detector Type
1		0.322	10.188	43.520	53.709	-25.377	79.086	AVERAGE
2		0.388	10.132	41.110	51.242	-25.958	77.200	AVERAGE
3		0.474	10.065	46.580	56.645	-18.098	74.743	AVERAGE
4		16.228	9.955	49.820	59.775	-14.225	74.000	AVERAGE
5	*	18.244	10.024	51.110	61.134	-12.866	74.000	AVERAGE
6		19.709	10.078	50.360	60.438	-13.562	74.000	AVERAGE

Note:

1. All Reading Levels are Quasi-Peak and average value.
2. " * ", means this data is the worst emission level.
3. Measurement Level = Reading Level + Correct Factor

Site : SR1	Time : 2012/09/06 - 00:48
Limit : ISN_Voltage_A_00M_QP	Margin : 10
EUT : Network Camera	Probe : TESEQ_T8 - Line1
Power : By PoE	Note : Mode 3, ISN 10Mbps

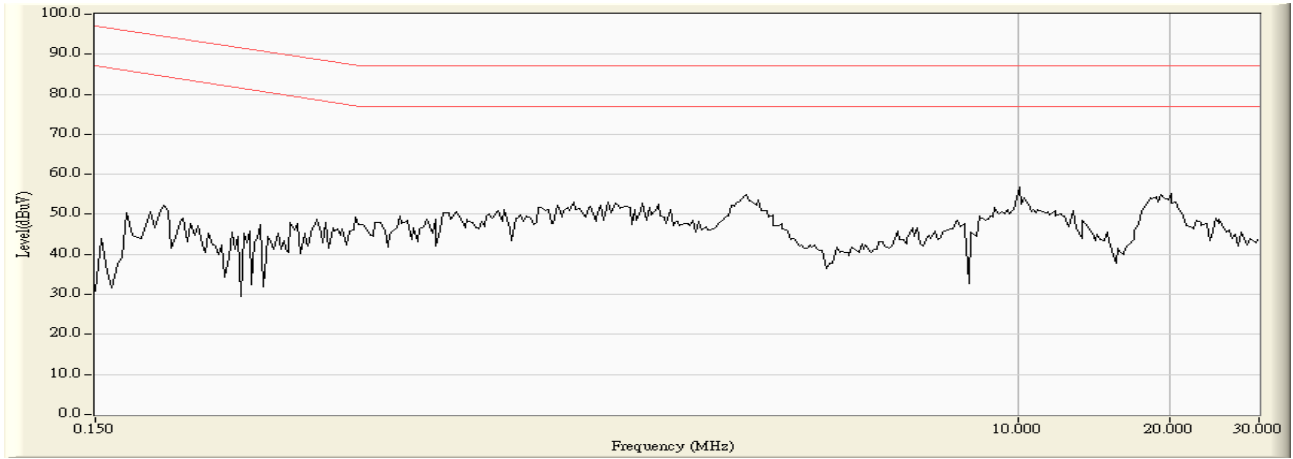

Site : SR1	Time : 2012/09/06 - 00:50
Limit : ISN_Voltage_A_00M_QP	Margin : 0
EUT : Network Camera	Probe : TESEQ_T8 - Line1
Power : By PoE	Note : Mode 3, ISN 10Mbps

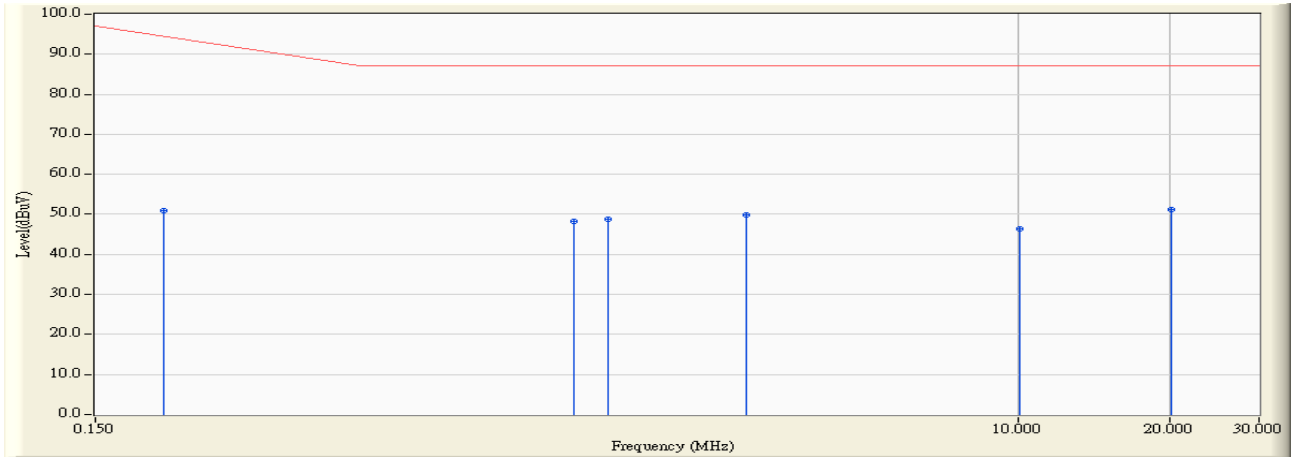

		Frequency (MHz)	Correct Factor (dB)	Reading Level (dBuV)	Measure Level (dBuV)	Margin (dB)	Limit (dBuV)	Detector Type
1		0.205	10.294	40.670	50.964	-44.465	95.429	QUASIPeAK
2		1.326	9.926	38.340	48.266	-38.734	87.000	QUASIPeAK
3		1.545	9.907	38.880	48.787	-38.213	87.000	QUASIPeAK
4		2.904	9.889	39.970	49.860	-37.140	87.000	QUASIPeAK
5		10.072	9.910	36.470	46.380	-40.620	87.000	QUASIPeAK
6	*	20.158	10.080	41.050	51.130	-35.870	87.000	QUASIPeAK

Note:

1. All Reading Levels are Quasi-Peak and average value.
2. " * ", means this data is the worst emission level.
3. Measurement Level = Reading Level + Correct Factor

Site : SR1	Time : 2012/09/06 - 00:50
Limit : ISN_Voltage_A_00M_AV	Margin : 0
EUT : Network Camera	Probe : TESEQ_T8 - Line1
Power : By PoE	Note : Mode 3, ISN 10Mbps

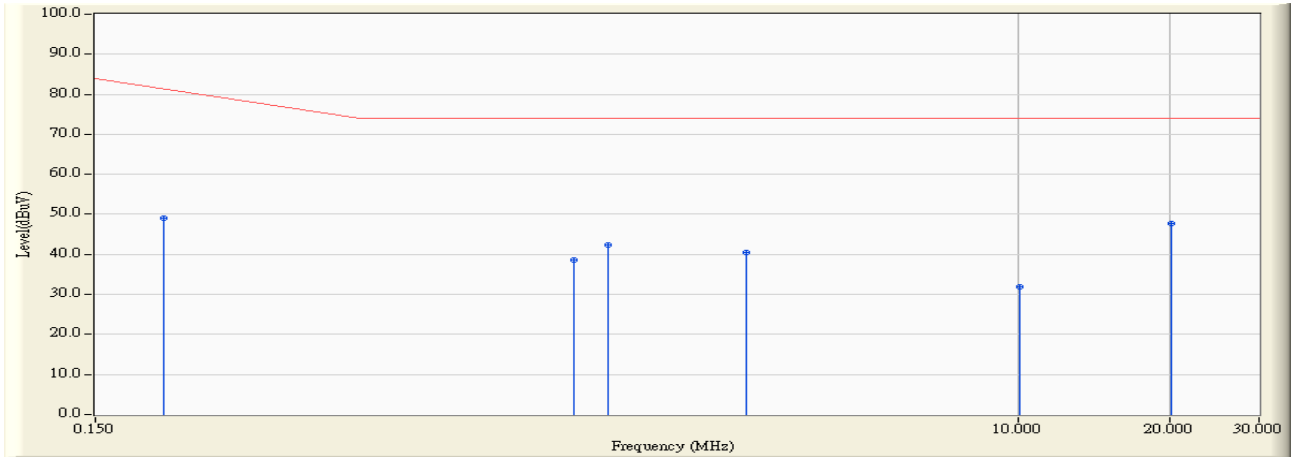

		Frequency (MHz)	Correct Factor (dB)	Reading Level (dBuV)	Measure Level (dBuV)	Margin (dB)	Limit (dBuV)	Detector Type
1		0.205	10.294	38.700	48.994	-33.435	82.429	AVERAGE
2		1.326	9.926	28.770	38.696	-35.304	74.000	AVERAGE
3		1.545	9.907	32.500	42.407	-31.593	74.000	AVERAGE
4		2.904	9.889	30.510	40.400	-33.600	74.000	AVERAGE
5		10.072	9.910	21.880	31.790	-42.210	74.000	AVERAGE
6	*	20.158	10.080	37.570	47.650	-26.350	74.000	AVERAGE

Note:

1. All Reading Levels are Quasi-Peak and average value.
2. " * ", means this data is the worst emission level.
3. Measurement Level = Reading Level + Correct Factor

Site : SR1	Time : 2012/09/06 - 00:51
Limit : ISN_Voltage_A_00M_QP	Margin : 10
EUT : Network Camera	Probe : TESEQ_T8 - Line1
Power : By PoE	Note : Mode 3, ISN 100Mbps

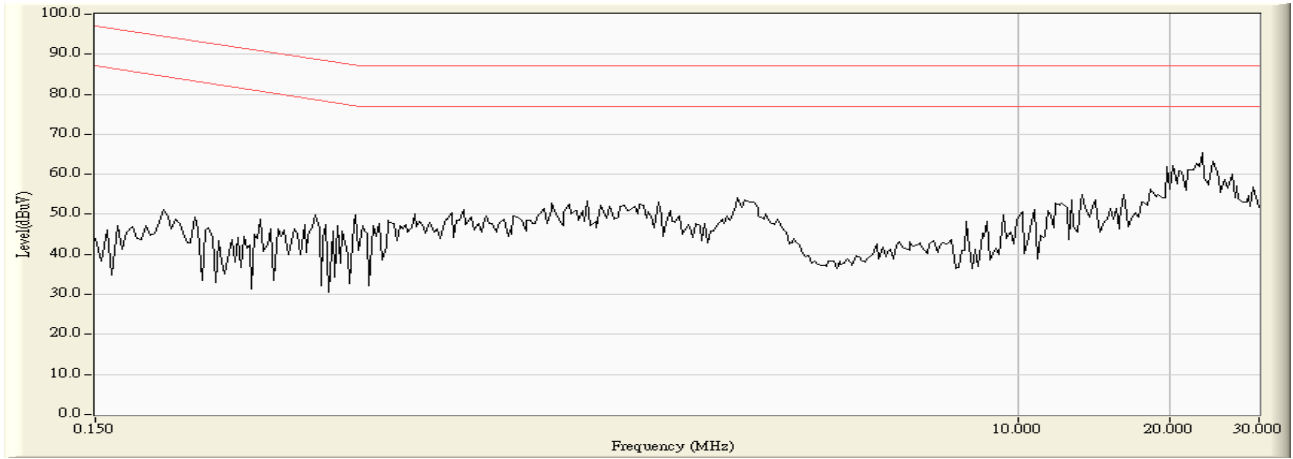

Site : SR1	Time : 2012/09/06 - 00:53
Limit : ISN_Voltage_A_00M_QP	Margin : 0
EUT : Network Camera	Probe : TESEQ_T8 - Line1
Power : By PoE	Note : Mode 3, ISN 100Mbps

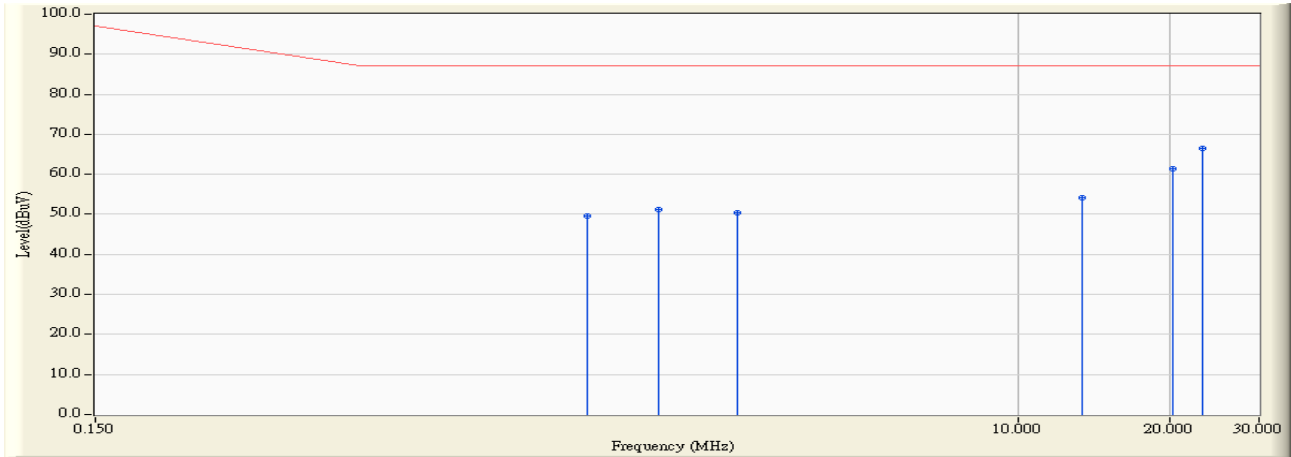

		Frequency (MHz)	Correct Factor (dB)	Reading Level (dBuV)	Measure Level (dBuV)	Margin (dB)	Limit (dBuV)	Detector Type
1		1.408	9.916	39.640	49.556	-37.444	87.000	QUASIPeAK
2		1.953	9.879	41.370	51.249	-35.751	87.000	QUASIPeAK
3		2.795	9.889	40.580	50.469	-36.531	87.000	QUASIPeAK
4		13.420	9.921	44.210	54.131	-32.869	87.000	QUASIPeAK
5		20.259	10.087	51.440	61.527	-25.473	87.000	QUASIPeAK
6	*	23.129	10.140	56.420	66.560	-20.440	87.000	QUASIPeAK

Note:

1. All Reading Levels are Quasi-Peak and average value.
2. " * ", means this data is the worst emission level.
3. Measurement Level = Reading Level + Correct Factor

Site : SR1	Time : 2012/09/06 - 00:53
Limit : ISN_Voltage_A_00M_AV	Margin : 0
EUT : Network Camera	Probe : TESEQ_T8 - Line1
Power : By PoE	Note : Mode 3, ISN 100Mbps

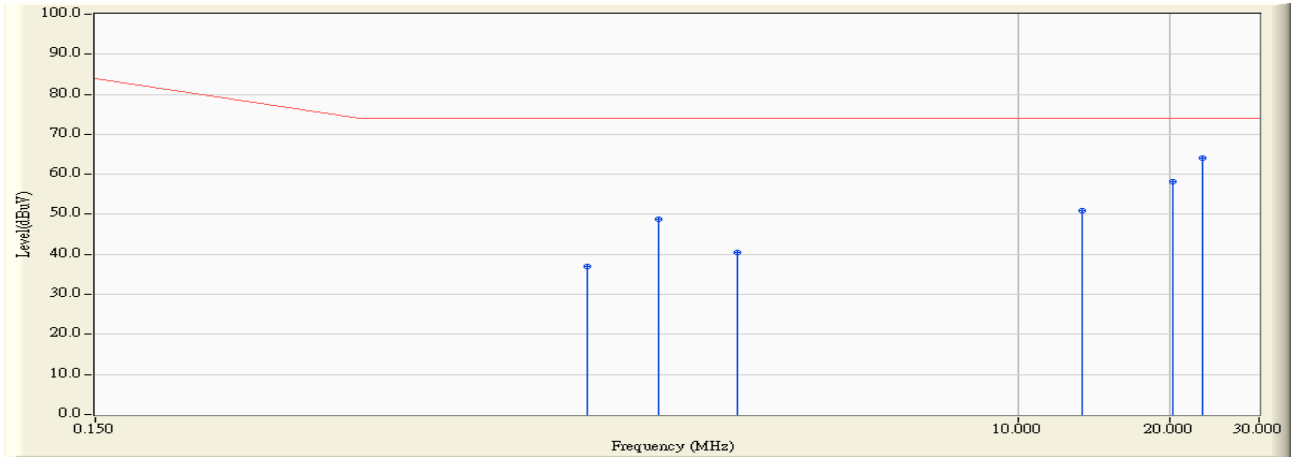

		Frequency (MHz)	Correct Factor (dB)	Reading Level (dBuV)	Measure Level (dBuV)	Margin (dB)	Limit (dBuV)	Detector Type
1		1.408	9.916	27.020	36.936	-37.064	74.000	AVERAGE
2		1.953	9.879	38.950	48.829	-25.171	74.000	AVERAGE
3		2.795	9.889	30.620	40.509	-33.491	74.000	AVERAGE
4		13.420	9.921	40.990	50.911	-23.089	74.000	AVERAGE
5		20.259	10.087	48.220	58.307	-15.693	74.000	AVERAGE
6	*	23.129	10.140	54.010	64.150	-9.850	74.000	AVERAGE

Note:

1. All Reading Levels are Quasi-Peak and average value.
2. " * ", means this data is the worst emission level.
3. Measurement Level = Reading Level + Correct Factor

4.7. Test Photograph

Test Mode : Mode 1: AC 24V

Description : Front View of ISN Test



Test Mode : Mode 1: AC 24V

Description : Back View of ISN Test

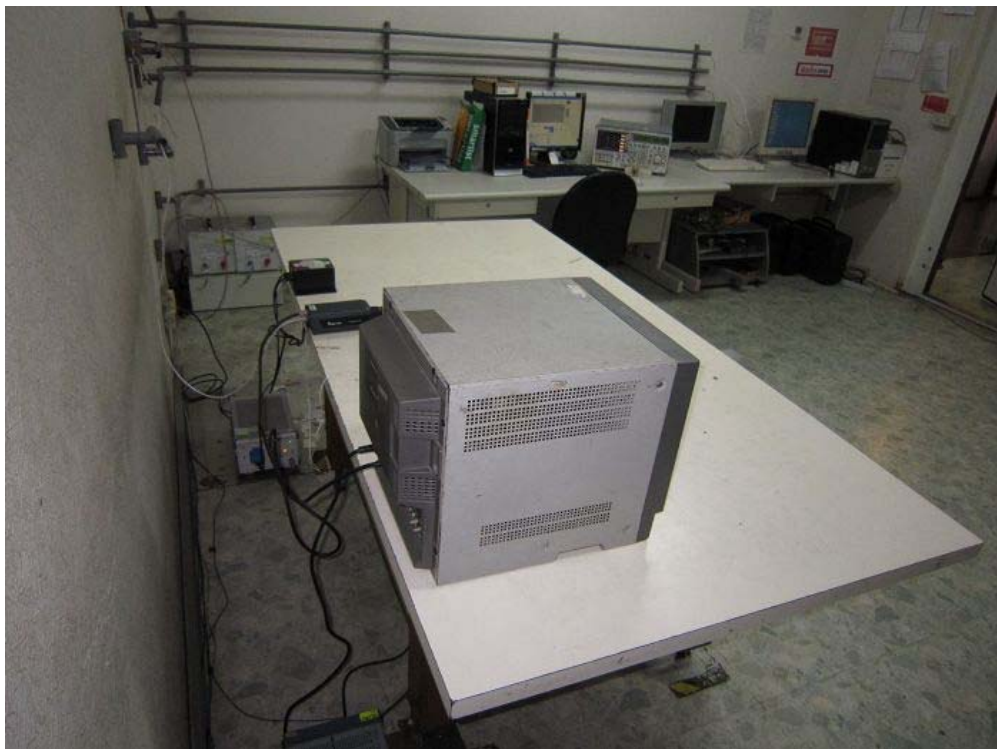

Test Mode : Mode 2: DC 12V

Description : Front View of ISN Test



Test Mode : Mode 2: DC 12V

Description : Back View of ISN Test



Test Mode : Mode 3: PoE
Description : Front View of ISN Test



Test Mode : Mode 3: PoE
Description : Back View of ISN Test

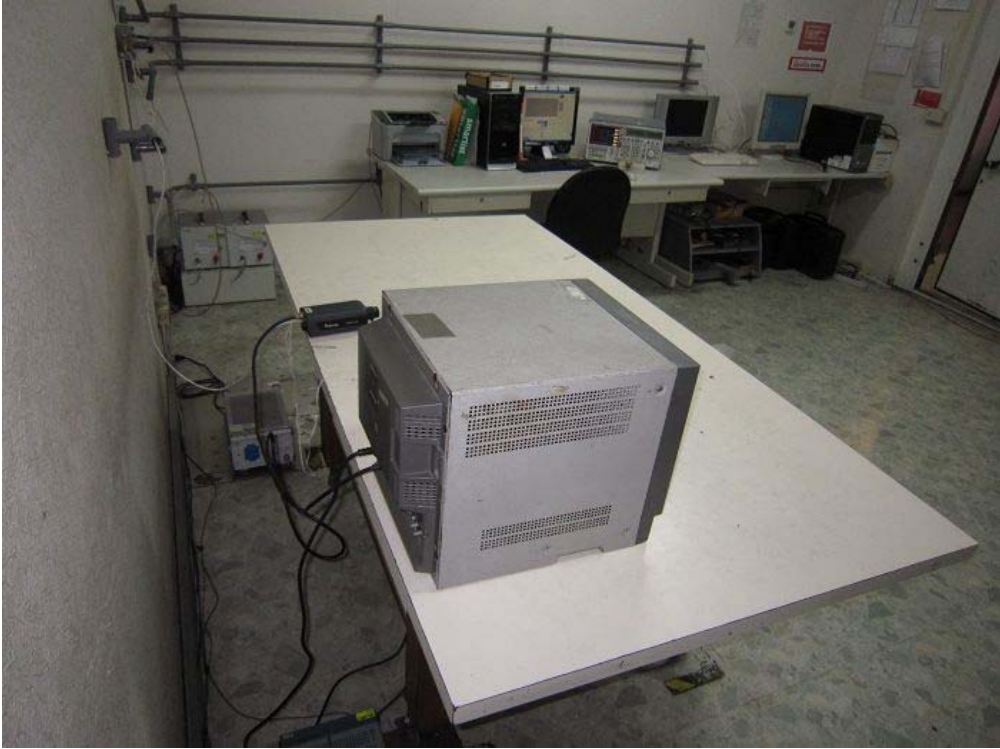

5. Radiated Emission

5.1. Test Specification

According to EMC Standard : EN 55022 and AS/NZS CISPR 22

5.2. Test Setup

Under 1GHz Test Setup:

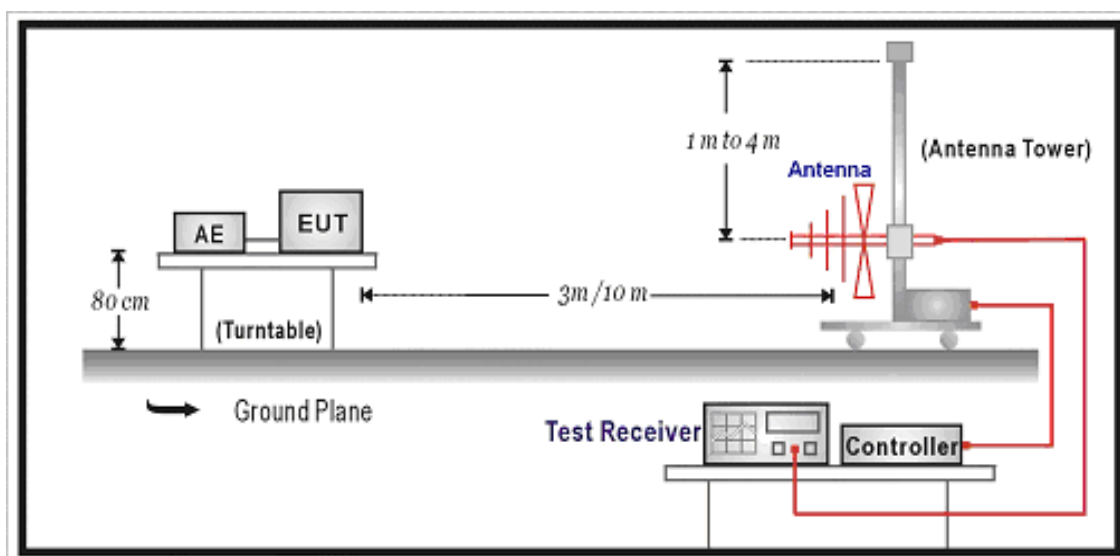

Above 1GHz Test Setup:

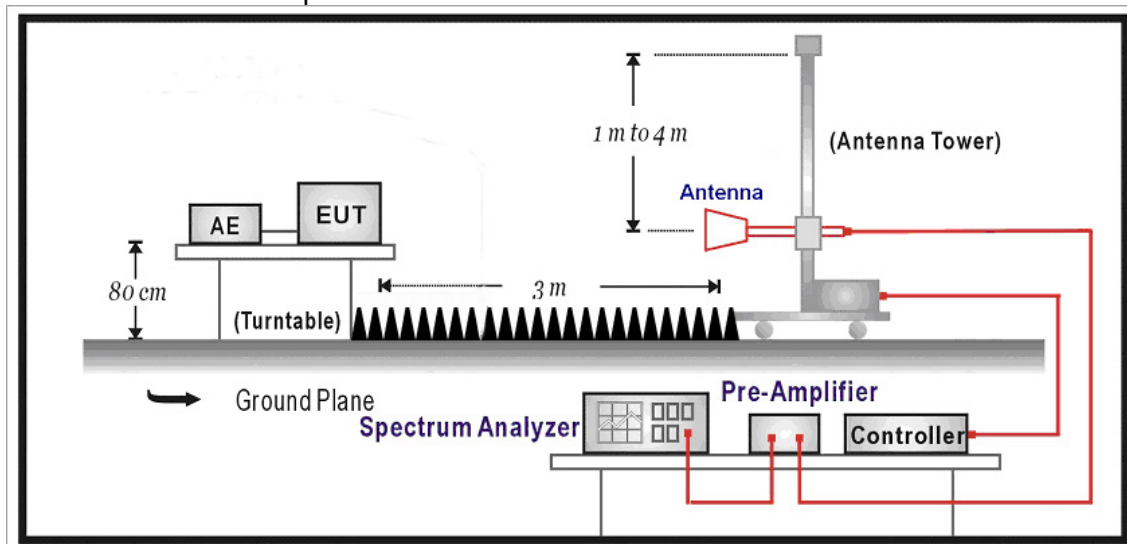

5.3. Limit

Limits		
Frequency MHz	Distance (m)	dBuV/m
30 – 230	10	40
230 – 1000	10	47

Limits			
Frequency (GHz)	Distance (m)	Peak (dBuV/m)	Average (dBuV/m)
1 – 3	3	76	56
3 – 6	3	80	60

Remark:

1. The tighter limit shall apply at the edge between two frequency bands.
2. Distance refers to the distance in meters between the measuring instrument antenna and the closed point of any part of the device or system.

Highest frequency generated or used in the device or on which the device operates or tunes (MHz)	Upper frequency of measurement range (MHz)
Below 108	1000
108 – 500	2000
500 – 1000	5000
Above 1000	5 th harmonic of the highest frequency or 6 GHz, whichever is lower

5.4. Test Procedure

The EUT and its simulators are placed on a turn table which is 0.8 meter above ground. The turn table can rotate 360 degrees to determine the position of the maximum emission level. The EUT was positioned such that the distance from antenna to the EUT was 3/10 meters. The antenna can move up and down between 1 meter and 4 meters to find out the maximum emission level.

Both horizontal and vertical polarization of the antenna are set on measurement. In order to find the maximum emission, all of the interface cables must be manipulated on radiated measurement.

Radiated emissions were investigated over the frequency range from 30MHz to 1GHz using a receiver bandwidth of 120kHz and above 1GHz using a receiver bandwidth of 1MHz.

30MHz to 1GHz Radiated was performed at an antenna to EUT distance of 10 meters.

Above 1GHz Radiated was performed at an antenna to EUT distance of 3 meters.

It is placed with absorb on the ground between EUT and Antenna.

5.5. Deviation from Test Standard

No deviation.

5.6. Test Result

Site : Site7	Time : 2012/09/04 - 14:40
Limit : CISPR_A_10M_QP	Margin : 6
EUT : Network Camera	Probe : Site7_CBL6112_10M_1207 - HORIZONTAL
Power : AC 230V/50Hz to AC 24V	Note : Mode 1

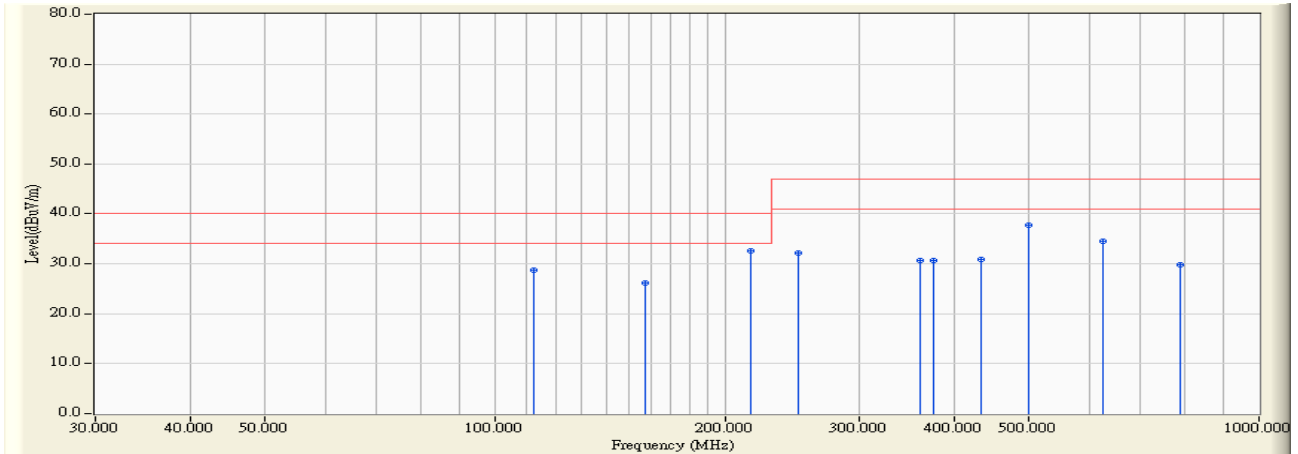

	Frequency (MHz)	Correct Factor (dB)	Reading Level (dBuV)	Measure Level (dBuV/m)	Margin (dB)	Limit (dBuV/m)	Detector Type
1	112.500	-18.597	47.400	28.802	-11.198	40.000	QUASIPeAK
2	157.500	-19.708	45.800	26.092	-13.908	40.000	QUASIPeAK
3	* 216.000	-19.899	52.400	32.500	-7.500	40.000	QUASIPeAK
4	250.000	-16.104	48.200	32.096	-14.904	47.000	QUASIPeAK
5	360.000	-12.842	43.600	30.758	-16.242	47.000	QUASIPeAK
6	375.000	-12.226	42.900	30.674	-16.326	47.000	QUASIPeAK
7	432.000	-10.243	41.200	30.957	-16.043	47.000	QUASIPeAK
8	500.000	-8.699	46.400	37.701	-9.299	47.000	QUASIPeAK
9	625.000	-6.346	40.800	34.454	-12.546	47.000	QUASIPeAK
10	787.520	-3.990	33.800	29.810	-17.190	47.000	QUASIPeAK

Note:

1. All Readings below 1GHz are Quasi-Peak, above are performed with peak and/or average measurements as necessary.
2. " * ", means this data is the worst emission level.
3. Measurement Level = Reading Level + Correct Factor

Site : Site7	Time : 2012/09/04 - 14:29
Limit : CISPR_A_10M_QP	Margin : 6
EUT : Network Camera	Probe : Site7_CBL6112_10M_1207 - VERTICAL
Power : AC 230V/50Hz to AC 24V	Note : Mode 1

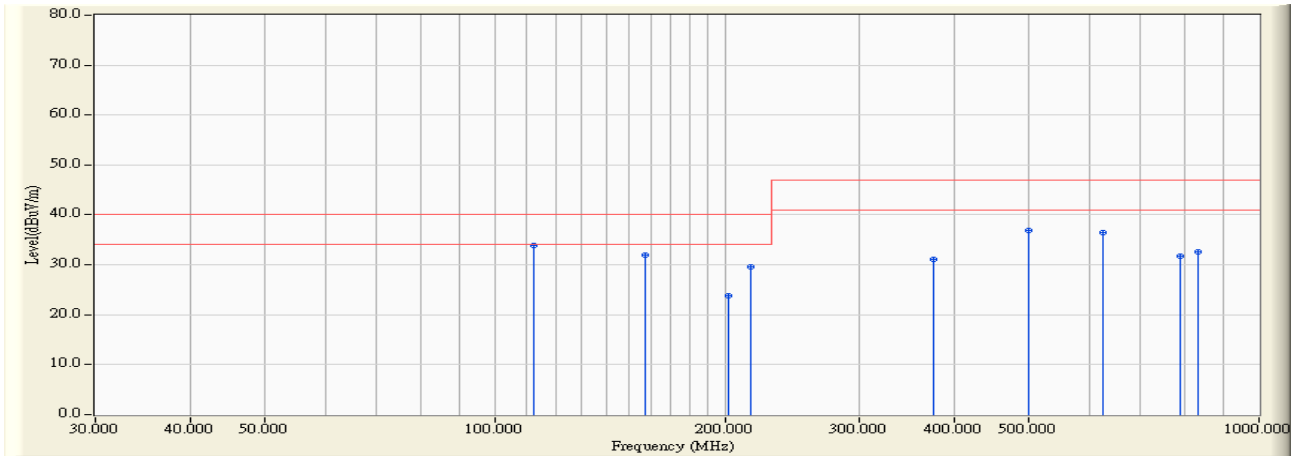

		Frequency (MHz)	Correct Factor (dB)	Reading Level (dBuV)	Measure Level (dBuV/m)	Margin (dB)	Limit (dBuV/m)	Detector Type
1	*	112.500	-18.597	52.500	33.902	-6.098	40.000	QUASPEAK
2		157.500	-19.708	51.700	31.992	-8.008	40.000	QUASPEAK
3		202.500	-20.111	44.000	23.890	-16.110	40.000	QUASPEAK
4		216.000	-19.899	49.400	29.500	-10.500	40.000	QUASPEAK
5		375.000	-12.226	43.300	31.074	-15.926	47.000	QUASPEAK
6		500.000	-8.699	45.500	36.801	-10.199	47.000	QUASPEAK
7		625.000	-6.346	42.700	36.354	-10.646	47.000	QUASPEAK
8		787.520	-3.990	35.800	31.810	-15.190	47.000	QUASPEAK
9		832.520	-3.317	35.900	32.583	-14.417	47.000	QUASPEAK

Note:

1. All Readings below 1GHz are Quasi-Peak, above are performed with peak and/or average measurements as necessary.
2. " * ", means this data is the worst emission level.
3. Measurement Level = Reading Level + Correct Factor

Site : Site7	Time : 2012/09/04 - 09:35
Limit : CISPR_A_10M_QP	Margin : 6
EUT : Network Camera	Probe : Site7_CBL6112_10M_1207 - HORIZONTAL
Power : AC 230V/50Hz to DC 12V	Note : Mode 2

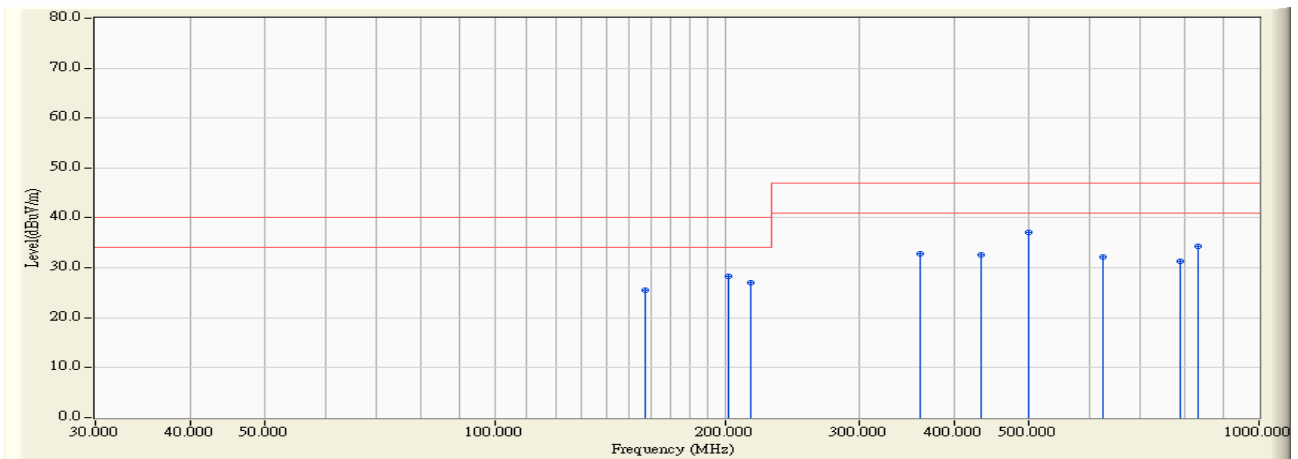

	Frequency (MHz)	Correct Factor (dB)	Reading Level (dBuV)	Measure Level (dBuV/m)	Margin (dB)	Limit (dBuV/m)	Detector Type
1	157.522	-19.708	45.249	25.541	-14.459	40.000	QUASPEAK
2	202.492	-20.111	48.366	28.255	-11.745	40.000	QUASPEAK
3	216.004	-19.899	46.897	26.998	-13.002	40.000	QUASPEAK
4	360.003	-12.842	45.652	32.810	-14.190	47.000	QUASPEAK
5	432.003	-10.243	42.741	32.498	-14.502	47.000	QUASPEAK
6	* 500.001	-8.699	45.764	37.065	-9.935	47.000	QUASPEAK
7	624.993	-6.346	38.565	32.219	-14.781	47.000	QUASPEAK
8	787.511	-3.990	35.320	31.330	-15.670	47.000	QUASPEAK
9	832.511	-3.317	37.537	34.220	-12.780	47.000	QUASPEAK

Note:

1. All Readings below 1GHz are Quasi-Peak, above are performed with peak and/or average measurements as necessary.
2. " * ", means this data is the worst emission level.
3. Measurement Level = Reading Level + Correct Factor

Site : Site7	Time : 2012/09/04 - 09:53
Limit : CISPR_A_10M_QP	Margin : 6
EUT : Network Camera	Probe : Site7_CBL6112_10M_1207 - VERTICAL
Power : AC 230V/50Hz to DC 12V	Note : Mode 2

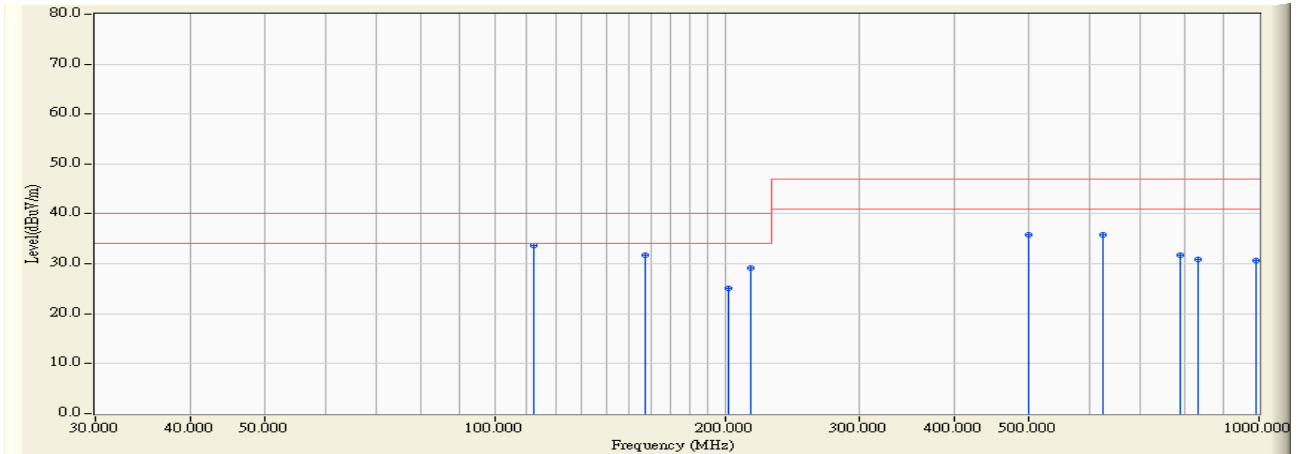

		Frequency (MHz)	Correct Factor (dB)	Reading Level (dBuV)	Measure Level (dBuV/m)	Margin (dB)	Limit (dBuV/m)	Detector Type
1	*	112.493	-18.597	52.369	33.772	-6.228	40.000	QUASIPeAK
2		157.491	-19.708	51.404	31.696	-8.304	40.000	QUASIPeAK
3		202.501	-20.111	45.165	25.054	-14.946	40.000	QUASIPeAK
4		216.003	-19.899	49.019	29.120	-10.880	40.000	QUASIPeAK
5		500.005	-8.699	44.555	35.856	-11.144	47.000	QUASIPeAK
6		624.991	-6.346	42.218	35.872	-11.128	47.000	QUASIPeAK
7		787.514	-3.990	35.658	31.668	-15.332	47.000	QUASIPeAK
8		832.510	-3.317	34.245	30.928	-16.072	47.000	QUASIPeAK
9		989.995	-1.490	32.184	30.694	-16.306	47.000	QUASIPeAK

Note:

1. All Readings below 1GHz are Quasi-Peak, above are performed with peak and/or average measurements as necessary.
2. " * ", means this data is the worst emission level.
3. Measurement Level = Reading Level + Correct Factor

Site : Site7	Time : 2012/09/04 - 15:14
Limit : CISPR_A_10M_QP	Margin : 6
EUT : Network Camera	Probe : Site7_CBL6112_10M_1207 - HORIZONTAL
Power : By PoE	Note : Mode 3

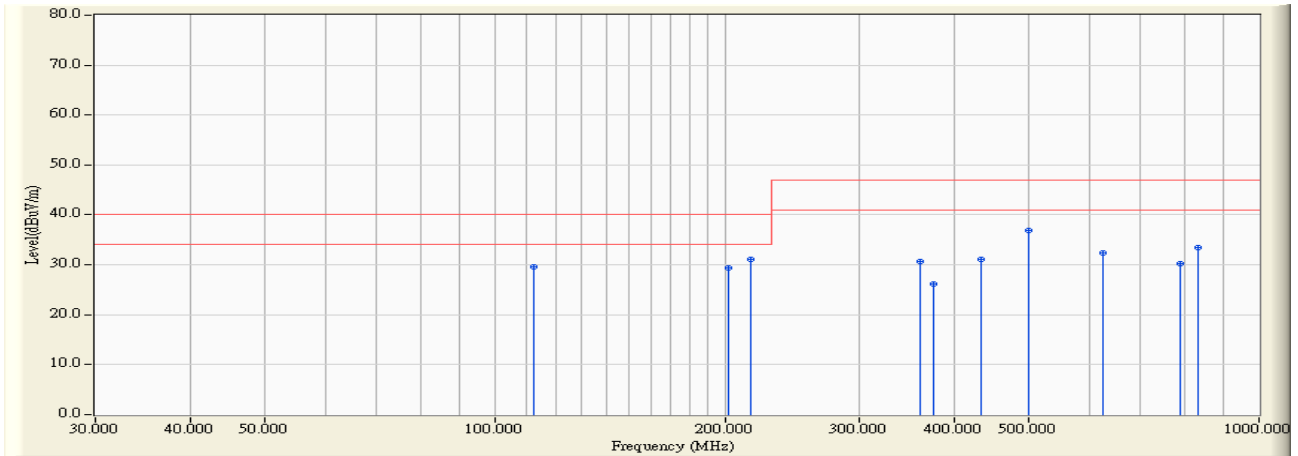

		Frequency (MHz)	Correct Factor (dB)	Reading Level (dBuV)	Measure Level (dBuV/m)	Margin (dB)	Limit (dBuV/m)	Detector Type
1		112.500	-18.597	48.300	29.702	-10.298	40.000	QUASPEAK
2		202.500	-20.111	49.500	29.390	-10.610	40.000	QUASPEAK
3	*	216.000	-19.899	50.900	31.000	-9.000	40.000	QUASPEAK
4		360.000	-12.842	43.500	30.658	-16.342	47.000	QUASPEAK
5		375.000	-12.226	38.300	26.074	-20.926	47.000	QUASPEAK
6		432.000	-10.243	41.400	31.157	-15.843	47.000	QUASPEAK
7		500.000	-8.699	45.500	36.801	-10.199	47.000	QUASPEAK
8		625.000	-6.346	38.800	32.454	-14.546	47.000	QUASPEAK
9		787.520	-3.990	34.200	30.210	-16.790	47.000	QUASPEAK
10		832.520	-3.317	36.800	33.483	-13.517	47.000	QUASPEAK

Note:

1. All Readings below 1GHz are Quasi-Peak, above are performed with peak and/or average measurements as necessary.
2. " * ", means this data is the worst emission level.
3. Measurement Level = Reading Level + Correct Factor

Site : Site7	Time : 2012/09/04 - 15:01
Limit : CISPR_A_10M_QP	Margin : 6
EUT : Network Camera	Probe : Site7_CBL6112_10M_1207 - VERTICAL
Power : By PoE	Note : Mode 3

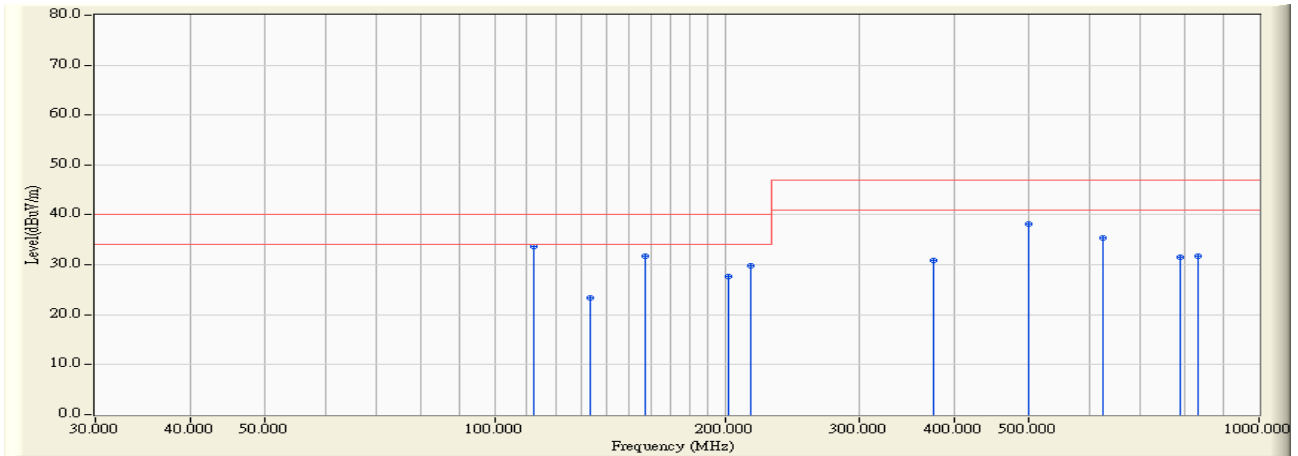

		Frequency (MHz)	Correct Factor (dB)	Reading Level (dBuV)	Measure Level (dBuV/m)	Margin (dB)	Limit (dBuV/m)	Detector Type
1	*	112.500	-18.597	52.200	33.602	-6.398	40.000	QUASPEAK
2		133.490	-18.638	42.100	23.462	-16.538	40.000	QUASPEAK
3		157.520	-19.708	51.400	31.691	-8.309	40.000	QUASPEAK
4		202.500	-20.111	47.800	27.690	-12.310	40.000	QUASPEAK
5		216.000	-19.899	49.700	29.800	-10.200	40.000	QUASPEAK
6		375.000	-12.226	43.100	30.874	-16.126	47.000	QUASPEAK
7		500.000	-8.699	46.900	38.201	-8.799	47.000	QUASPEAK
8		625.000	-6.346	41.800	35.454	-11.546	47.000	QUASPEAK
9		787.520	-3.990	35.600	31.610	-15.390	47.000	QUASPEAK
10		832.520	-3.317	35.000	31.683	-15.317	47.000	QUASPEAK

Note:

1. All Readings below 1GHz are Quasi-Peak, above are performed with peak and/or average measurements as necessary.
2. " * ", means this data is the worst emission level.
3. Measurement Level = Reading Level + Correct Factor

Site: CB7	Time: 2012/09/05 - 02:37
Limit: EN55022_A_(Above_1G)	Margin: 0
Probe: CB7_Horn_3117_1204	Polarity: Horizontal
EUT: Network Camera	Power: AC 230V/50Hz to AC 24V
Note: Mode 1	

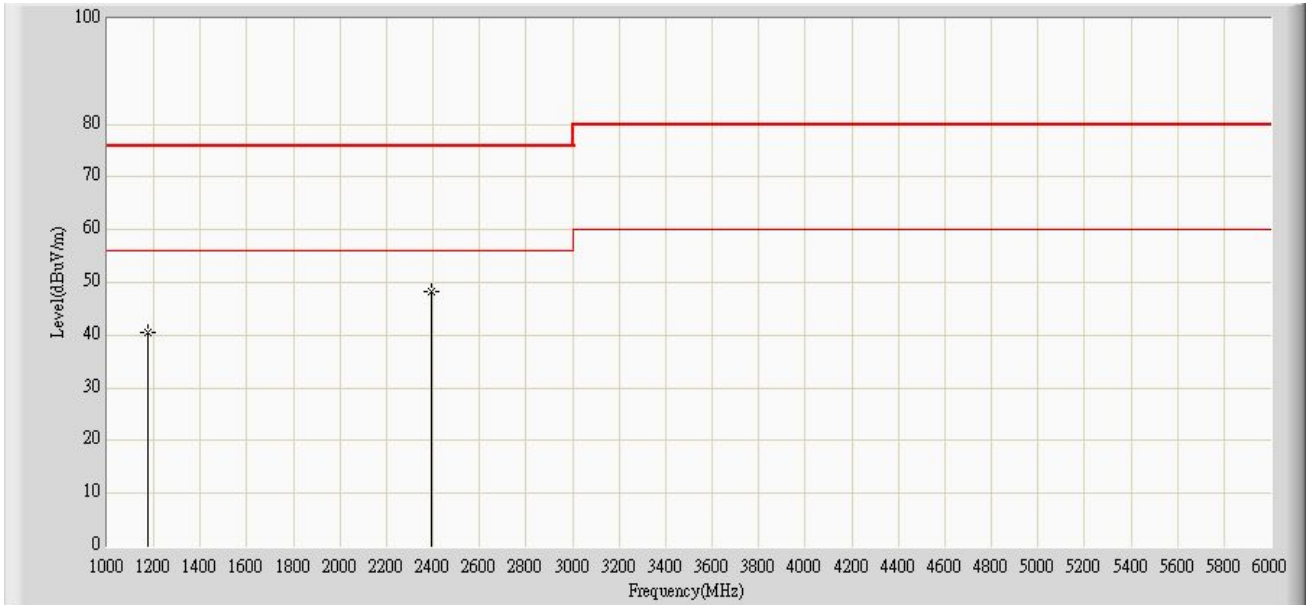

	Frequency (MHz)	Measure Level (dBuV/m)	Reading Level (dBuV)	Over Limit (dB)	Limit (dBuV/m)	Factor	Type
1	1175.000	40.479	42.810	-35.521	76.000	-2.331	PK
2	* 2395.000	48.172	45.680	-27.828	76.000	2.492	PK

Note:

1. All Readings below 1GHz are Quasi-Peak, above are performed with peak and/or average measurements as necessary.
2. " * ", means this data is the worst emission level.
3. Measurement Level = Reading Level + Factor(Probe+Cable-Amp).

Site: CB7	Time: 2012/09/05 - 02:39
Limit: EN55022_A_(Above_1G)	Margin: 0
Probe: CB7_Horn_3117_1204	Polarity: Vertical
EUT: Network Camera	Power: AC 230V/50Hz to AC 24V
Note: Mode 1	

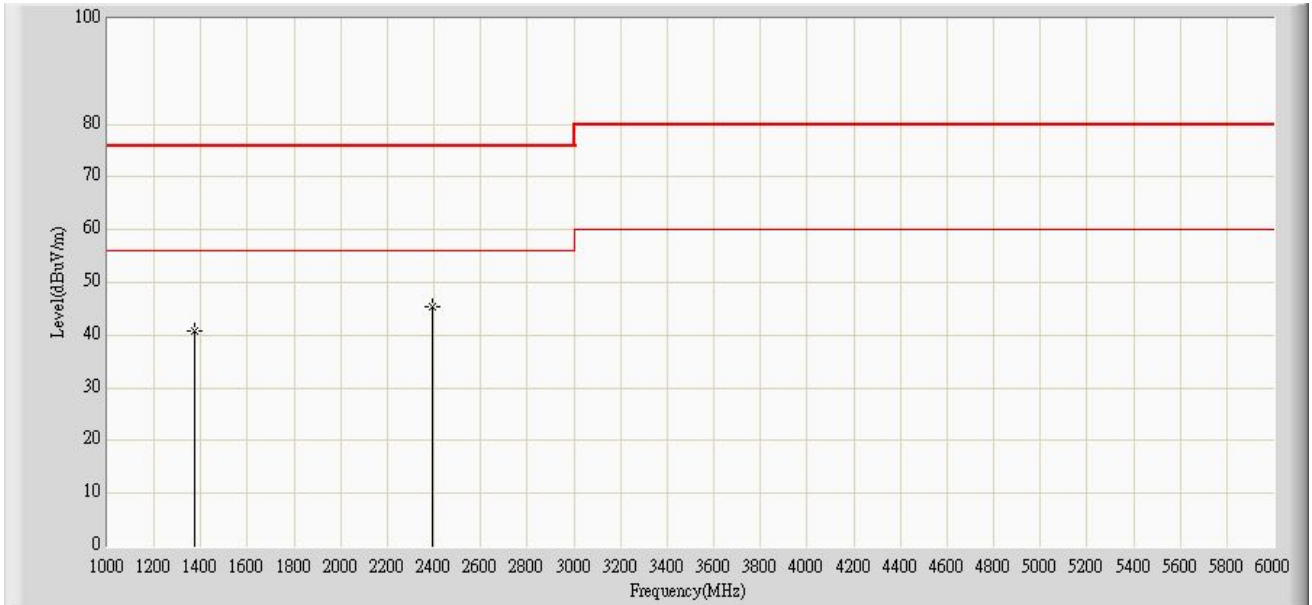

	Frequency (MHz)	Measure Level (dBuV/m)	Reading Level (dBuV)	Over Limit (dB)	Limit (dBuV/m)	Factor	Type
1	1375.000	40.732	42.870	-35.268	76.000	-2.137	PK
2	* 2393.000	45.478	42.990	-30.522	76.000	2.487	PK

Note:

1. All Readings below 1GHz are Quasi-Peak, above are performed with peak and/or average measurements as necessary.
2. " * ", means this data is the worst emission level.
3. Measurement Level = Reading Level + Factor(Probe+Cable-Amp).

Site: CB7	Time: 2012/09/05 - 02:00
Limit: EN55022_A_(Above_1G)	Margin: 0
Probe: CB7_Horn_3117_1204	Polarity: Horizontal
EUT: Network Camera	Power: AC 230V/50Hz to DC 12V
Note: Mode 2	

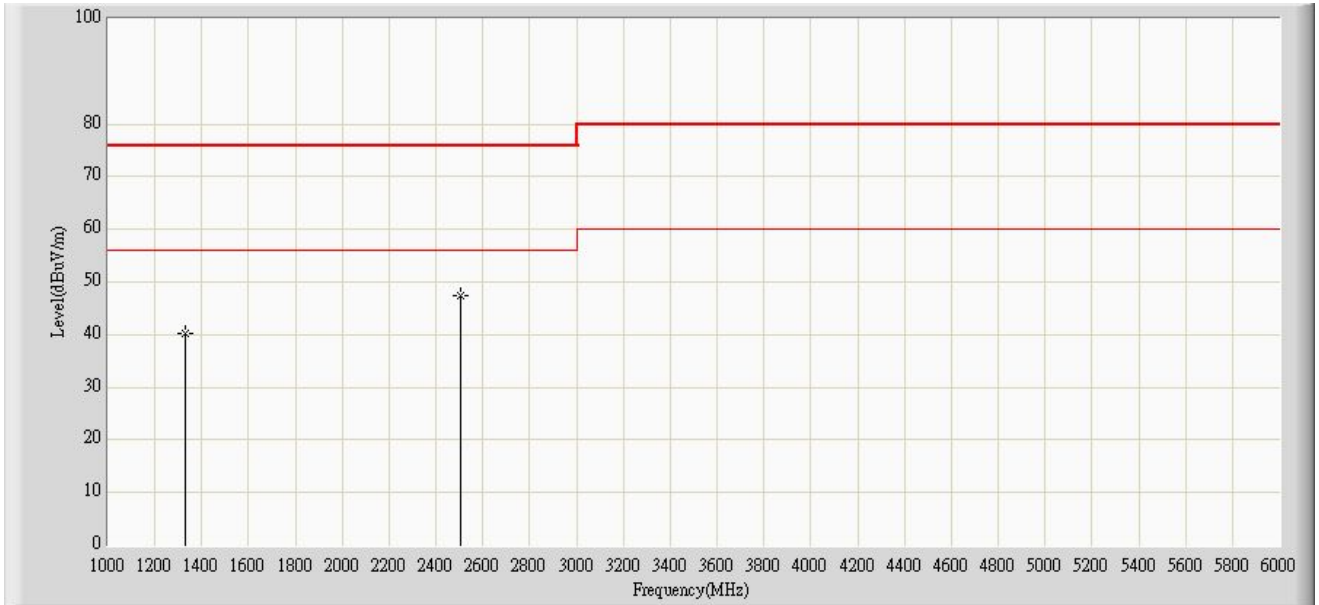

	Frequency (MHz)	Measure Level (dBuV/m)	Reading Level (dBuV)	Over Limit (dB)	Limit (dBuV/m)	Factor	Type
1	1330.000	40.372	42.550	-35.628	76.000	-2.178	PK
2 *	2502.000	47.294	44.590	-28.706	76.000	2.705	PK

Note:

1. All Readings below 1GHz are Quasi-Peak, above are performed with peak and/or average measurements as necessary.
2. " * ", means this data is the worst emission level.
3. Measurement Level = Reading Level + Factor(Probe+Cable-Amp).

Site: CB7	Time: 2012/09/05 - 02:08
Limit: EN55022_A_(Above_1G)	Margin: 0
Probe: CB7_Horn_3117_1204	Polarity: Vertical
EUT: Network Camera	Power: AC 230V/50Hz to DC 12V
Note: Mode 2	

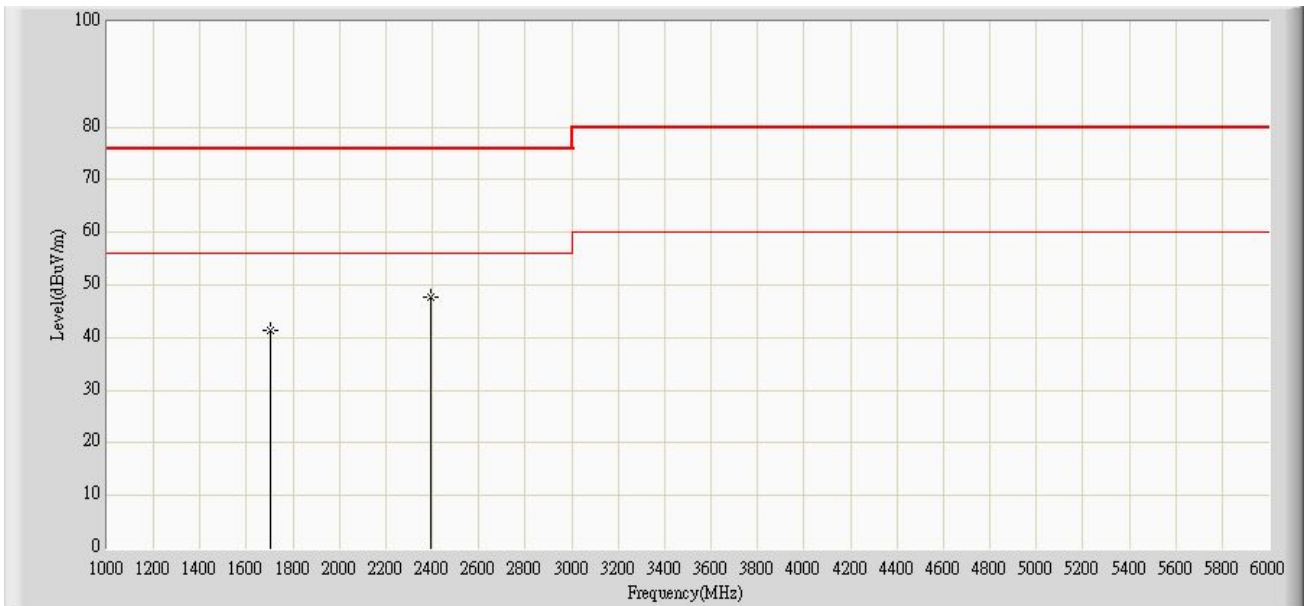

	Frequency (MHz)	Measure Level (dBuV/m)	Reading Level (dBuV)	Over Limit (dB)	Limit (dBuV/m)	Factor	Type
1	1700.000	41.333	41.850	-34.667	76.000	-0.517	PK
2	* 2395.000	47.732	45.240	-28.268	76.000	2.492	PK

Note:

1. All Readings below 1GHz are Quasi-Peak, above are performed with peak and/or average measurements as necessary.
2. " * ", means this data is the worst emission level.
3. Measurement Level = Reading Level + Factor(Probe+Cable-Amp).

Site: CB7	Time: 2012/09/05 - 02:24
Limit: EN55022_A_(Above_1G)	Margin: 0
Probe: CB7_Horn_3117_1204	Polarity: Horizontal
EUT: Network Camera	Power: By PoE
Note: Mode 3	

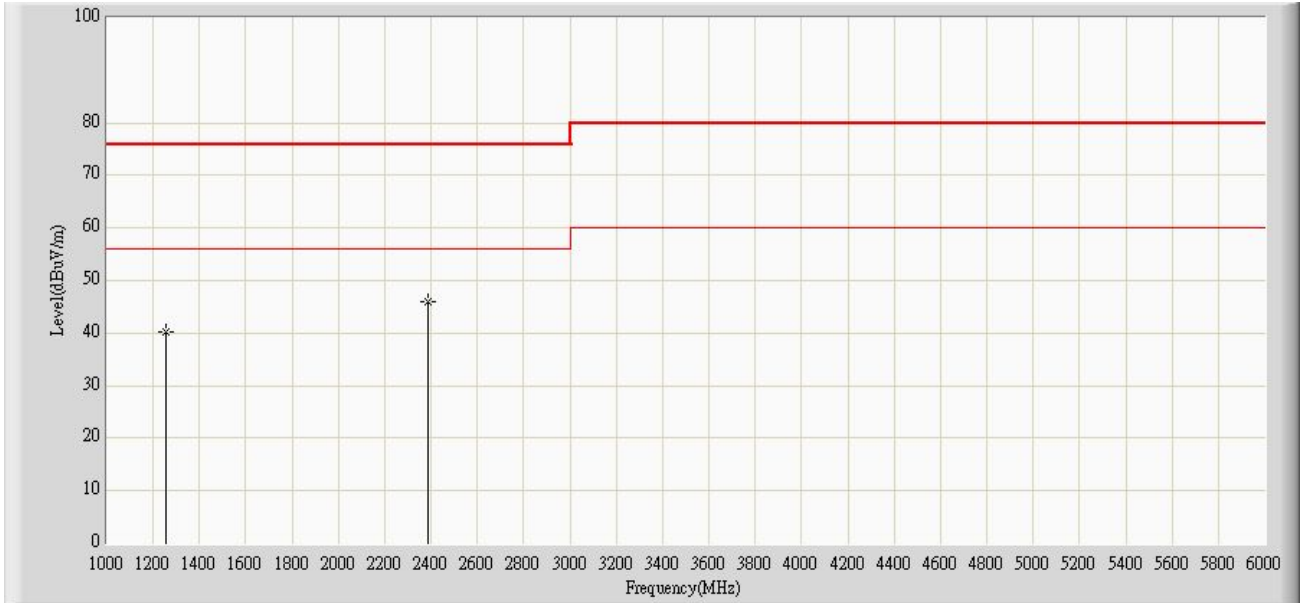

	Frequency (MHz)	Measure Level (dBuV/m)	Reading Level (dBuV)	Over Limit (dB)	Limit (dBuV/m)	Factor	Type
1	1255.000	40.300	42.550	-35.700	76.000	-2.250	PK
2	* 2389.000	45.988	43.510	-30.012	76.000	2.478	PK

Note:

1. All Readings below 1GHz are Quasi-Peak, above are performed with peak and/or average measurements as necessary.
2. " * ", means this data is the worst emission level.
3. Measurement Level = Reading Level + Factor(Probe+Cable-Amp).

Site: CB7	Time: 2012/09/05 - 02:26
Limit: EN55022_A_(Above_1G)	Margin: 0
Probe: CB7_Horn_3117_1204	Polarity: Vertical
EUT: Network Camera	Power: By PoE
Note: Mode 3	

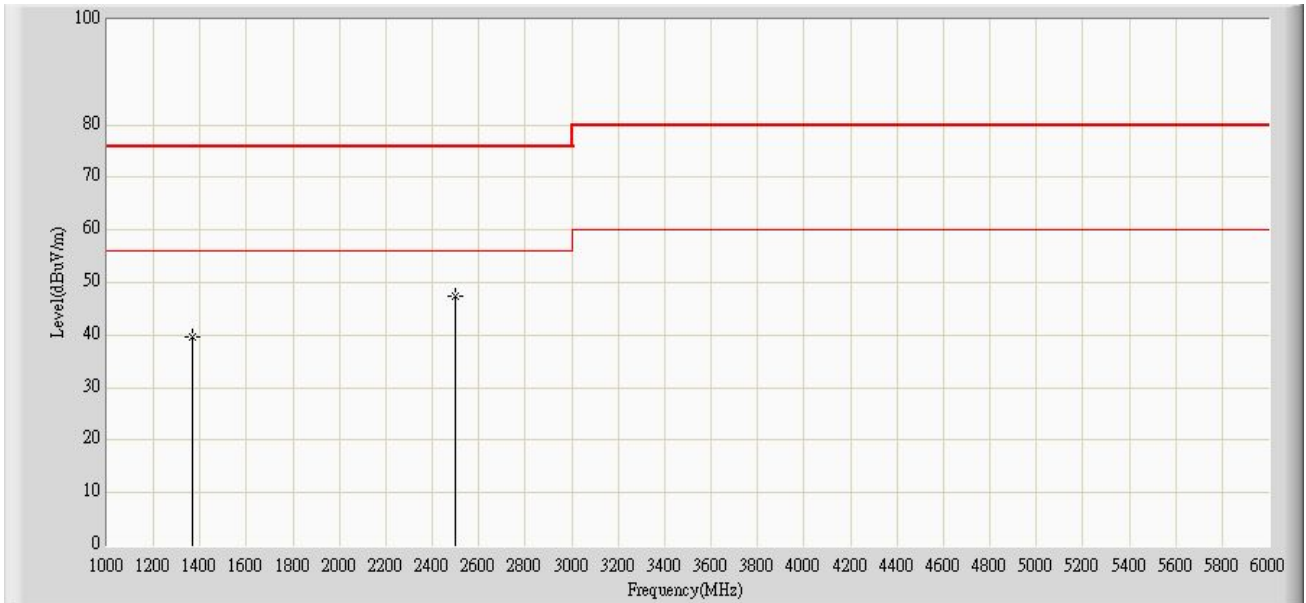

	Frequency (MHz)	Measure Level (dBuV/m)	Reading Level (dBuV)	Over Limit (dB)	Limit (dBuV/m)	Factor	Type
1	1365.000	39.755	41.900	-36.245	76.000	-2.145	PK
2	* 2500.000	47.549	44.850	-28.451	76.000	2.699	PK

Note:

1. All Readings below 1GHz are Quasi-Peak, above are performed with peak and/or average measurements as necessary.
2. " * ", means this data is the worst emission level.
3. Measurement Level = Reading Level + Factor(Probe+Cable-Amp).

Site: CB7	Time: 2012/10/24 - 10:57
Limit: EN55022_B_(Above_1G)	Margin: 0
Probe: CB7_Horn_3117_1204	Polarity: Horizontal
EUT: Network Camera	Power: AC 230V/50Hz
Note: Mode 1	

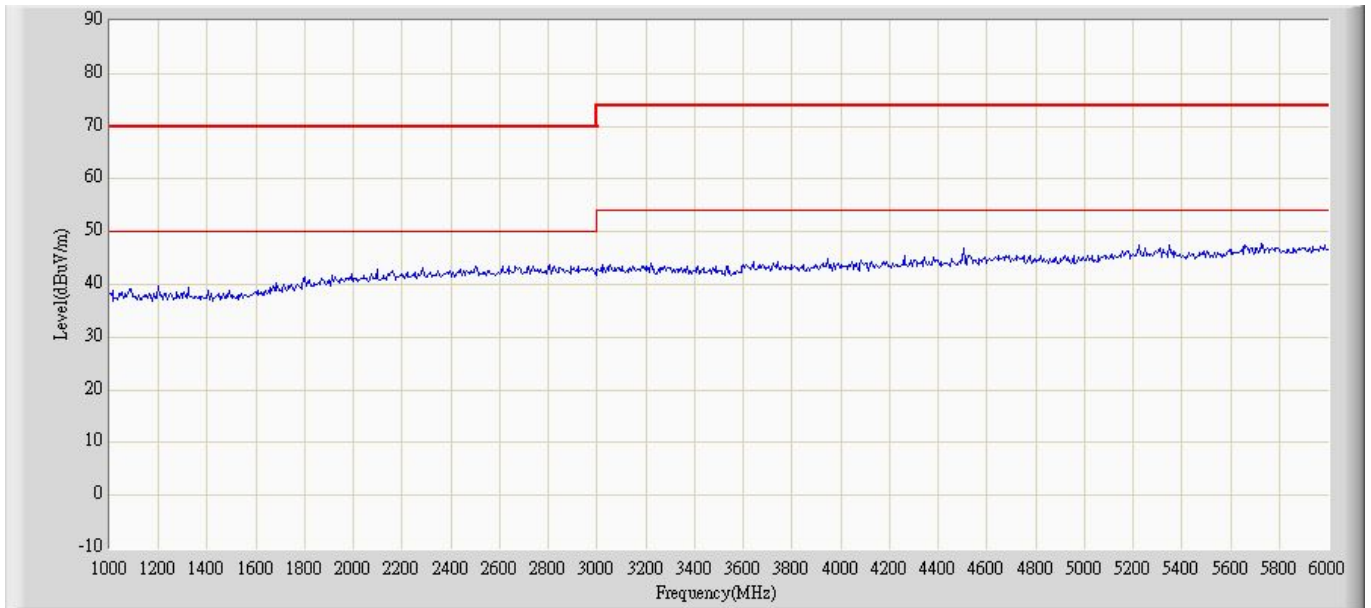

Site: CB7	Time: 2012/10/24 - 10:59
Limit: EN55022_B_(Above_1G)	Margin: 0
Probe: CB7_Horn_3117_1204	Polarity: Vertical
EUT: Network Camera	Power: AC 230V/50Hz
Note: Mode 1	

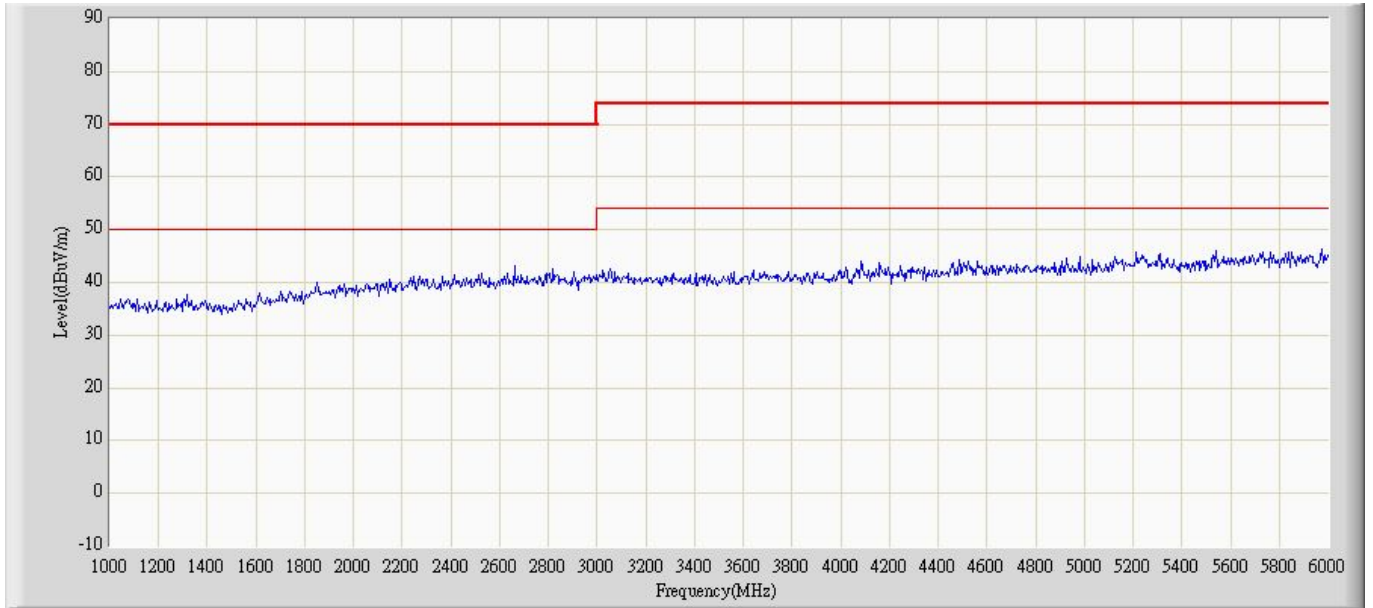

Site: CB7	Time: 2012/10/24 - 11:14
Limit: EN55022_A_(Above_1G)	Margin: 0
Probe: CB7_Horn_3117_1204	Polarity: Horizontal
EUT: Network Camera	Power: AC 230V/50Hz
Note: Mode 2	

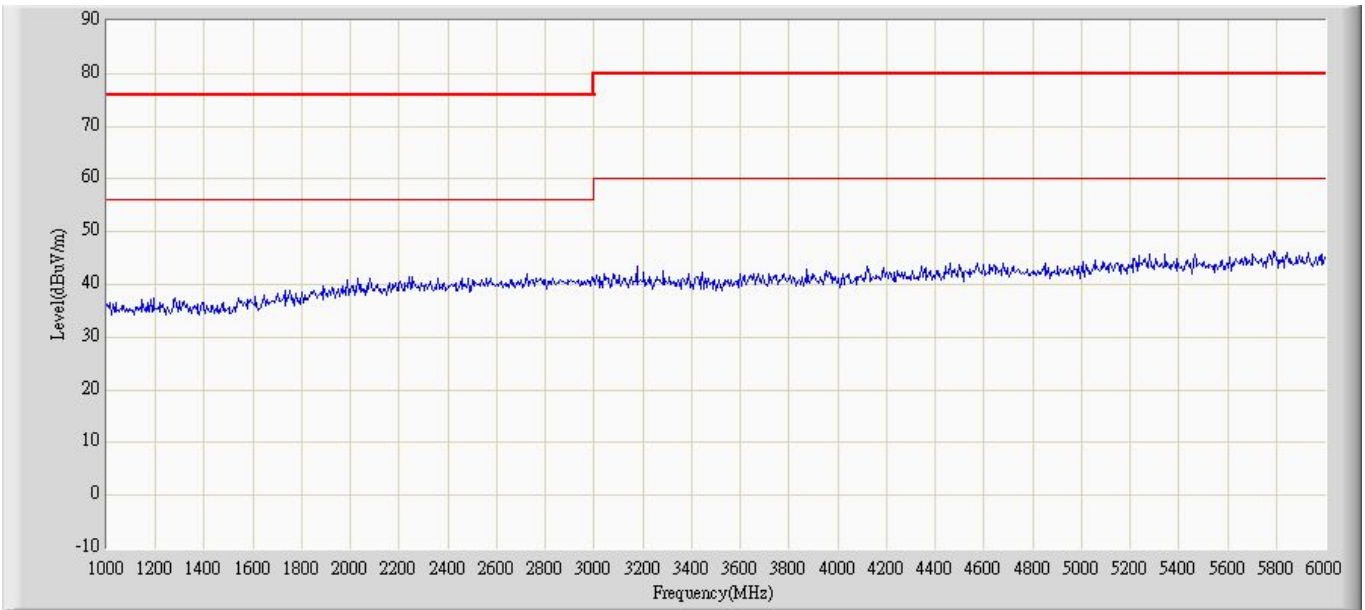

Site: CB7	Time: 2012/10/24 - 11:15
Limit: EN55022_A (Above_1G)	Margin: 0
Probe: CB7_Horn_3117_1204	Polarity: Vertical
EUT: Network Camera	Power: AC 230V/50Hz
Note: Mode 2	

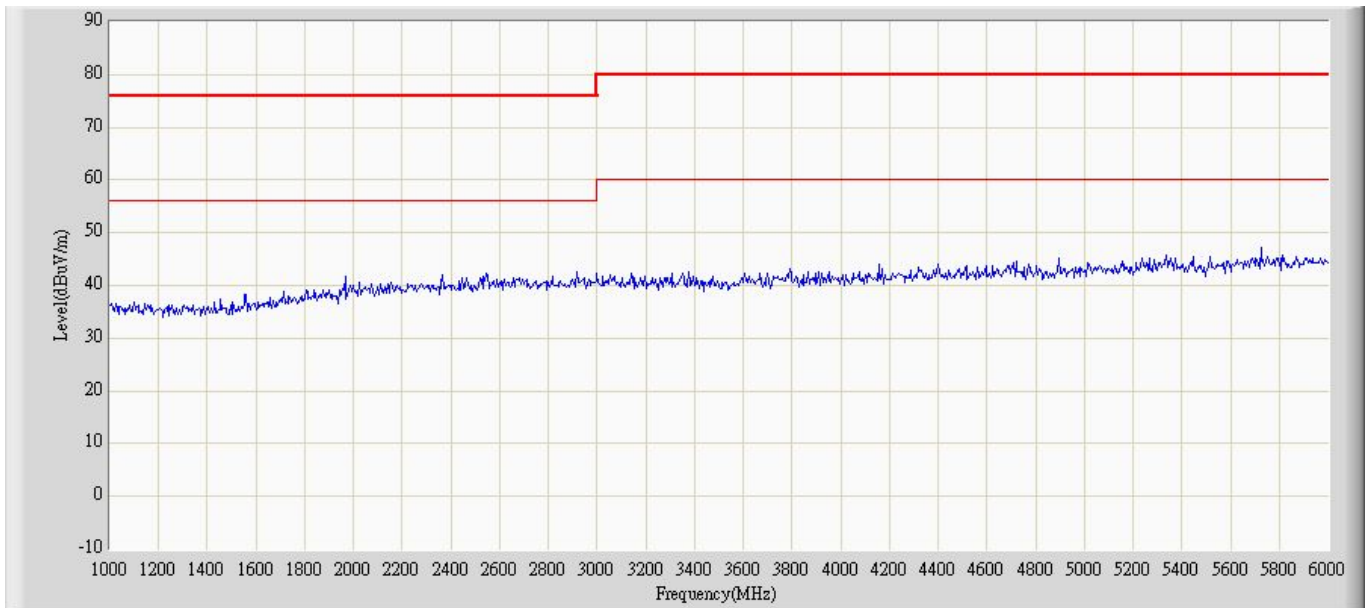

Site: CB7	Time: 2012/10/24 - 11:18
Limit: EN55022_A_(Above_1G)	Margin: 0
Probe: CB7_Horn_3117_1204	Polarity: Horizontal
EUT: Network Camera	Power: By POE
Note: Mode 3	

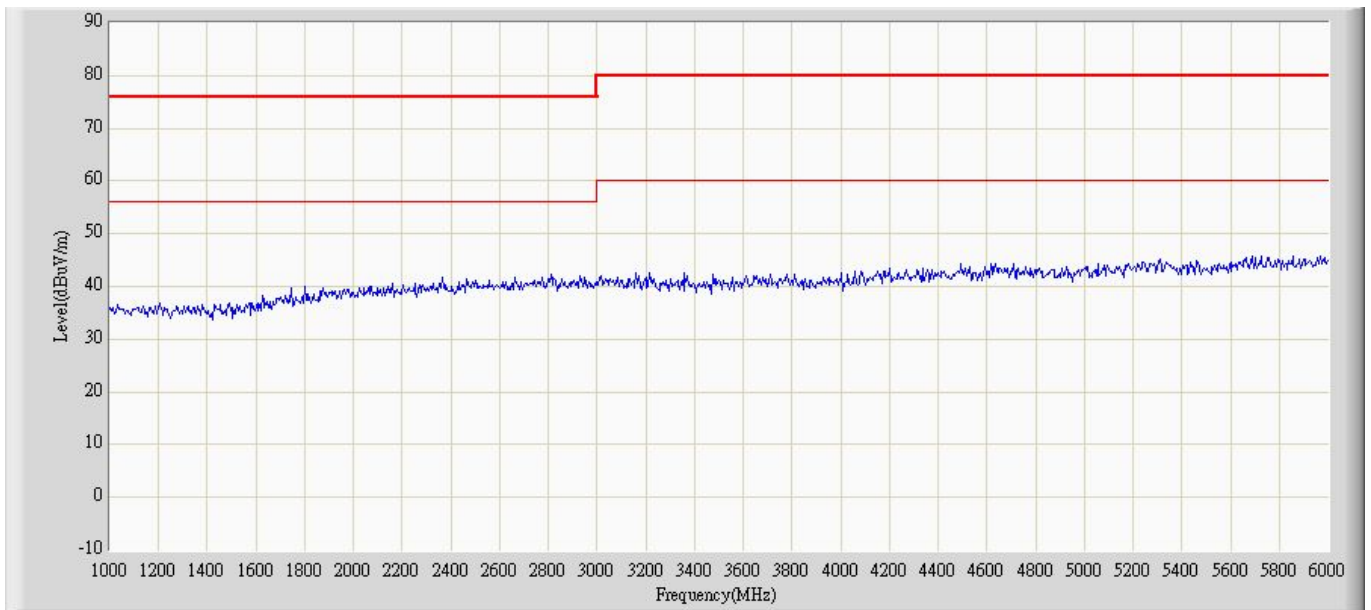

Site: CB7	Time: 2012/10/24 - 11:32
Limit: EN55022_A_(Above_1G)	Margin: 0
Probe: CB7_Horn_3117_1204	Polarity: Vertical
EUT: Network Camera	Power: By POE
Note: Mode 3	

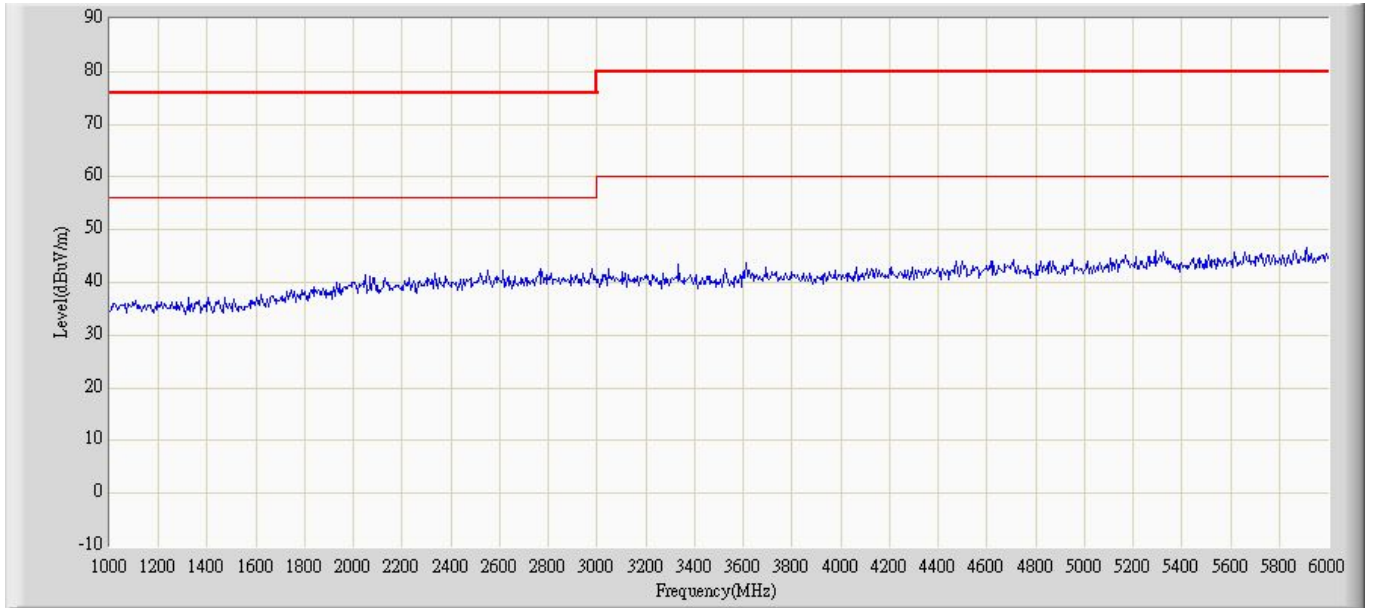

5.7. Test Photograph

Test Mode : Mode 1: AC 24V

Description : Front View of Radiated Test



Test Mode : Mode 1: AC 24V

Description : Back View of Radiated Test

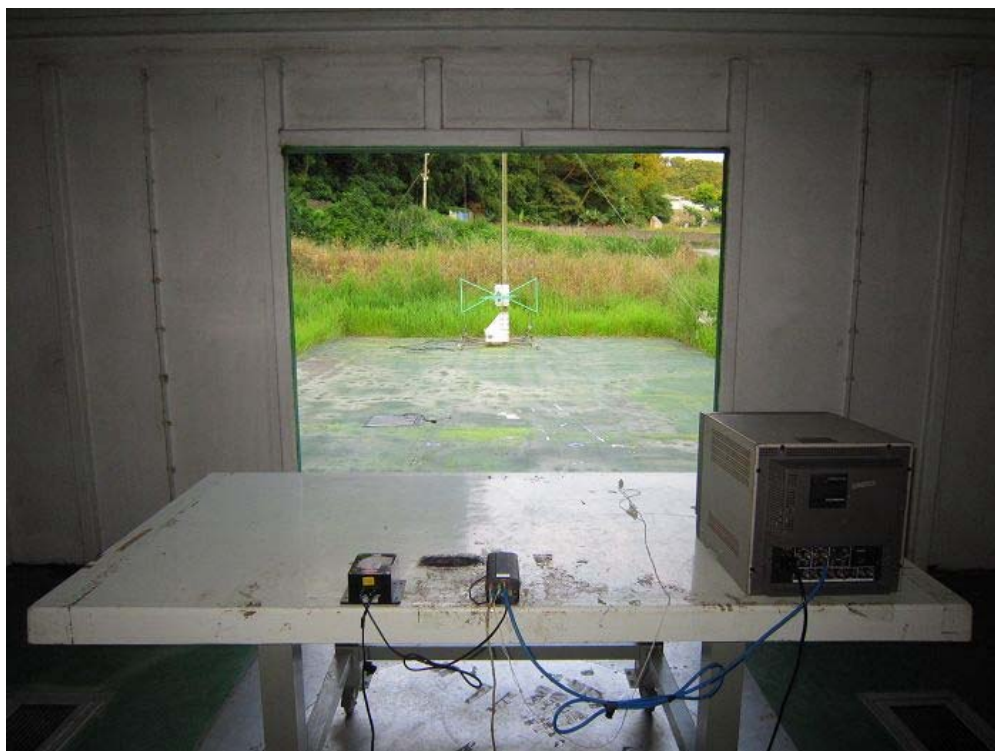

Test Mode : Mode 1: AC 24V

Description : Front View of High Frequency Radiated Test



Test Mode : Mode 2: DC 12V

Description : Front View of Radiated Test



Test Mode : Mode 2: DC 12V

Description : Back View of Radiated Test

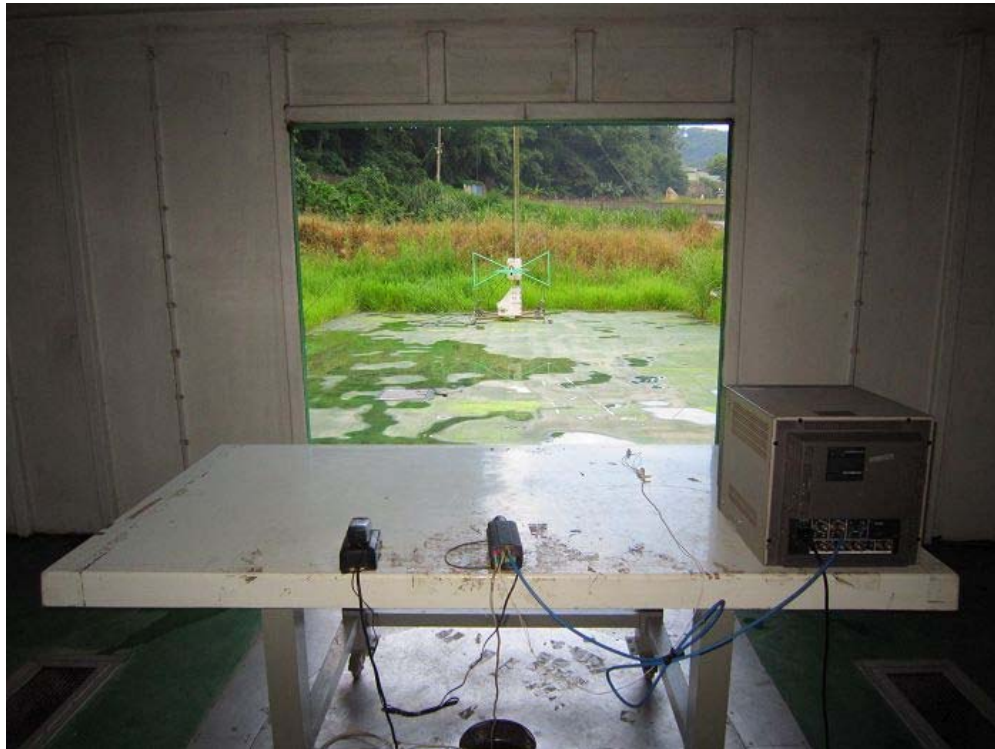

Test Mode : Mode 2: DC 12V

Description : Front View of High Frequency Radiated Test



Test Mode : Mode 3: PoE

Description : Front View of Radiated Test



Test Mode : Mode 3: PoE

Description : Back View of Radiated Test



Test Mode : Mode 3: PoE

Description : Front View of High Frequency Radiated Test



6. Harmonic Current Emission

6.1. Test Specification

According to EMC Standard : EN 61000-3-2

6.2. Test Setup

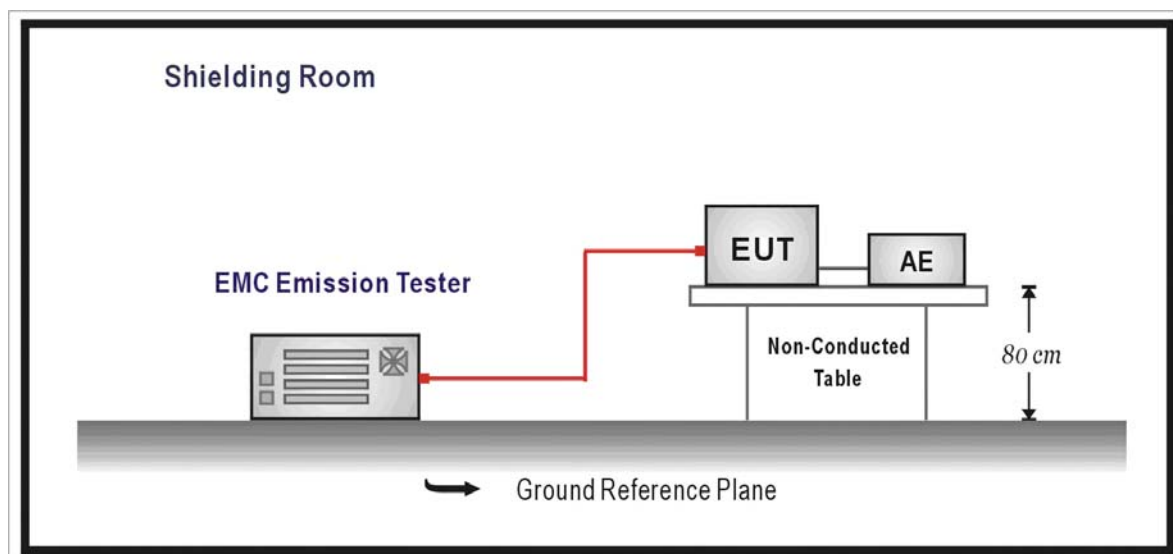

6.3. Limit

(a) Limits of Class A Harmonics Currents

Harmonics Order n	Maximum Permissible harmonic current A	Harmonics Order n	Maximum Permissible harmonic current A
Odd harmonics		Even harmonics	
3	2.30	2	1.08
5	1.14	4	0.43
7	0.77	6	0.30
9	0.40	$8 \leq n \leq 40$	$0.23 * 8/n$
11	0.33		
13	0.21		
$15 \leq n \leq 39$	$0.15 * 15/n$		

(b) Limits of Class B Harmonics Currents

For Class B equipment, the harmonic of the input current shall not exceed the maximum permissible values given in table that is the limit of Class A multiplied by a factor of 1.5.

(c) Limits of Class C Harmonics Currents

Harmonics Order n	Maximum Permissible harmonic current Expressed as a percentage of the input current at the fundamental frequency %
2	2
3	$30 \cdot \lambda^*$
5	10
7	7
9	5
$11 \leq n \leq 39$ (odd harmonics only)	3

* λ is the circuit power factor

(d) Limits of Class D Harmonics Currents

Harmonics Order n	Maximum Permissible harmonic current per watt mA/W	Maximum Permissible harmonic current A
3	3.4	2.30
5	1.9	1.14
7	1.0	0.77
9	0.5	0.40
11	0.35	0.33
$11 \leq n \leq 39$ (odd harmonics only)	$3.85/n$	See limit of Class A

6.4. Test Procedure

The EUT is supplied in series with power analyzer from a power source having the same normal voltage and frequency as the rated supply voltage and the equipment under test. And the rated voltage at the supply voltage of EUT of 0.94 times and 1.06 times shall be performed.

6.5. Deviation from Test Standard

No deviation.

6.6. Test Result

Product	Network Camera		
Test Item	Power Harmonics		
Test Mode	Mode 1: AC 24V		
Date of Test	2012/09/15	Test Site	No.3 Shielded Room

Test Result: Pass Source qualification: Normal

Current & voltage waveforms

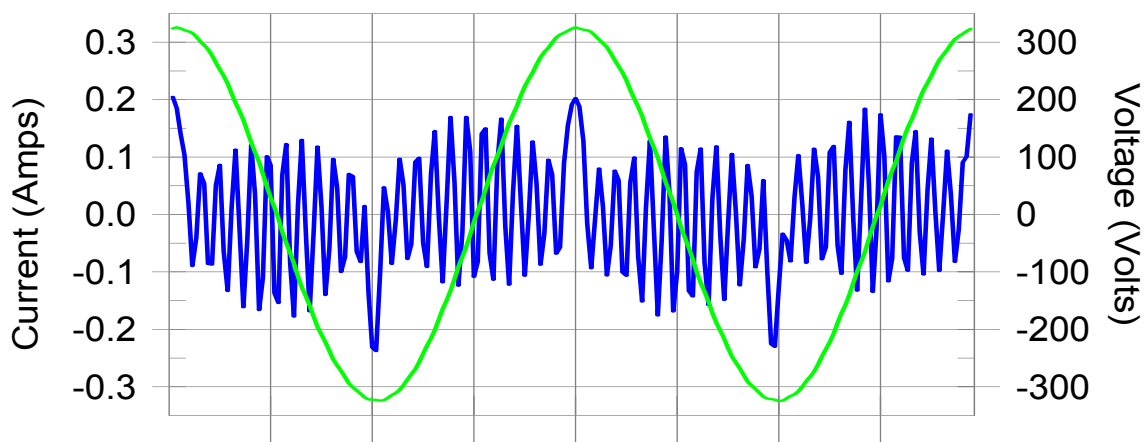

Harmonics and Class A limit line

European Limits

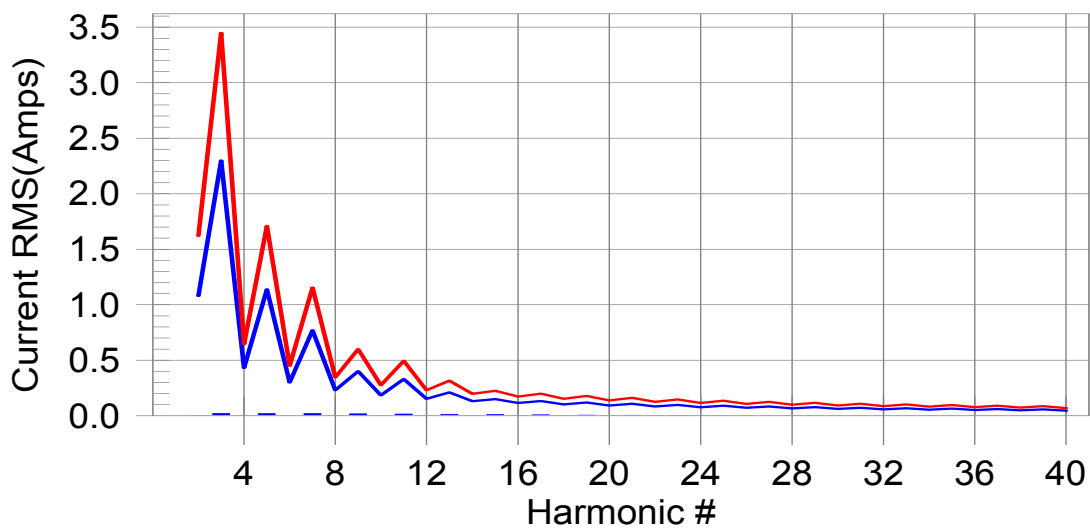

Test result: Pass Worst harmonic was #15 with 6.96% of the limit.

Test Result: Pass Source qualification: Normal
 THC(A): 0.05 I-THD(%): 166.83 POHC(A): 0.006 POHC Limit(A): 0.251
 Highest parameter values during test:

V_RMS (Volts):	229.48	Frequency(Hz):	50.00
I_Peak (Amps):	0.274	I_RMS (Amps):	0.105
I_Fund (Amps):	0.028	Crest Factor:	2.622
Power (Watts):	5.1	Power Factor:	0.213

Harm#	Harms(avg)	100%Limit	%of Limit	Harms(max)	150%Limit	%of Limit	Status
2	0.000	1.080	0.0	0.000	1.620	0.02	Pass
3	0.022	2.300	0.9	0.022	3.450	0.63	Pass
4	0.000	0.430	0.0	0.000	0.645	0.04	Pass
5	0.020	1.140	1.8	0.021	1.710	1.21	Pass
6	0.000	0.300	0.1	0.000	0.450	0.09	Pass
7	0.019	0.770	2.5	0.019	1.155	1.66	Pass
8	0.000	0.230	0.1	0.000	0.345	0.07	Pass
9	0.017	0.400	4.3	0.017	0.600	2.88	Pass
10	0.000	0.184	0.1	0.000	0.276	0.08	Pass
11	0.015	0.330	4.5	0.015	0.495	3.06	Pass
12	0.000	0.153	0.1	0.000	0.230	0.10	Pass
13	0.013	0.210	6.1	0.013	0.315	4.09	Pass
14	0.000	0.131	0.1	0.000	0.197	0.10	Pass
15	0.010	0.150	7.0	0.011	0.225	4.69	Pass
16	0.000	0.115	0.1	0.000	0.173	0.09	Pass
17	0.008	0.132	6.2	0.008	0.199	4.17	Pass
18	0.000	0.102	0.1	0.000	0.153	0.12	Pass
19	0.006	0.118	5.2	0.006	0.178	3.50	Pass
20	0.000	0.092	0.1	0.000	0.138	0.11	Pass
21	0.004	0.107	4.0	0.004	0.161	2.70	Pass
22	0.000	0.084	0.1	0.000	0.125	0.14	Pass
23	0.003	0.098	2.8	0.003	0.147	1.91	Pass
24	0.000	0.077	0.1	0.000	0.115	0.13	Pass
25	0.001	0.090	1.6	0.002	0.135	1.14	Pass
26	0.000	0.071	0.2	0.000	0.106	0.15	Pass
27	0.001	0.083	0.8	0.001	0.125	0.59	Pass
28	0.000	0.066	0.2	0.000	0.099	0.19	Pass
29	0.001	0.078	0.7	0.001	0.116	0.53	Pass
30	0.000	0.061	0.4	0.000	0.092	0.35	Pass
31	0.001	0.073	1.1	0.001	0.109	0.80	Pass
32	0.000	0.058	0.2	0.000	0.086	0.22	Pass
33	0.001	0.068	1.4	0.001	0.102	1.01	Pass
34	0.000	0.054	0.2	0.000	0.081	0.22	Pass
35	0.001	0.064	1.6	0.001	0.096	1.08	Pass
36	0.000	0.051	0.3	0.000	0.077	0.24	Pass
37	0.001	0.061	1.5	0.001	0.091	1.08	Pass
38	0.000	0.048	0.3	0.000	0.073	0.26	Pass
39	0.001	0.058	1.4	0.001	0.087	0.95	Pass
40	0.000	0.046	0.3	0.000	0.069	0.32	Pass

1. Dynamic limits were applied for this test. The highest harmonics values in the above table may not occur at the same window as the maximum harmonics/limit ratio.

2: According to EN61000-3-2 paragraph 7 the note 1 and 2 are valid for all applications having an active input power >75W. Others the result should be pass.

Product	Network Camera		
Test Item	Power Harmonics		
Test Mode	Mode 2: DC 12V		
Date of Test	2012/09/15	Test Site	No.3 Shielded Room

Test Result: Pass Source qualification: Normal

Current & voltage waveforms

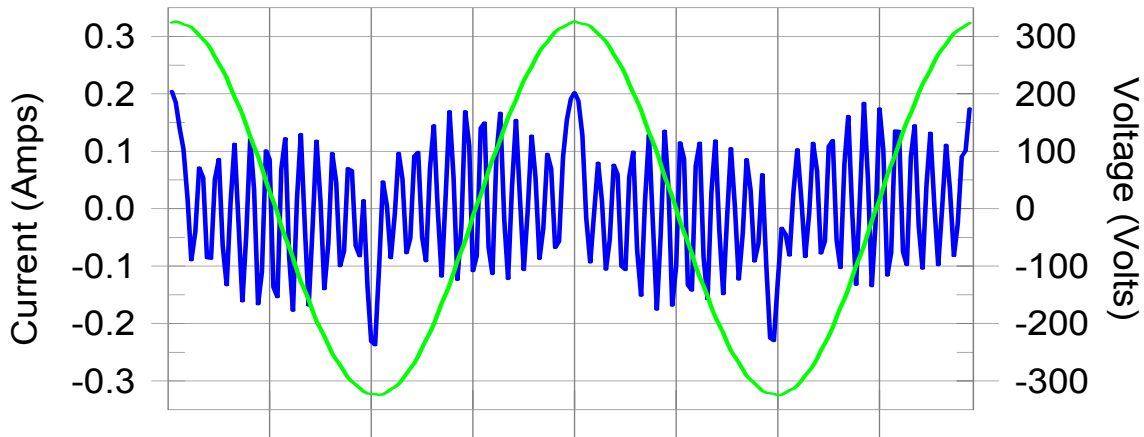

Harmonics and Class A limit line

European Limits

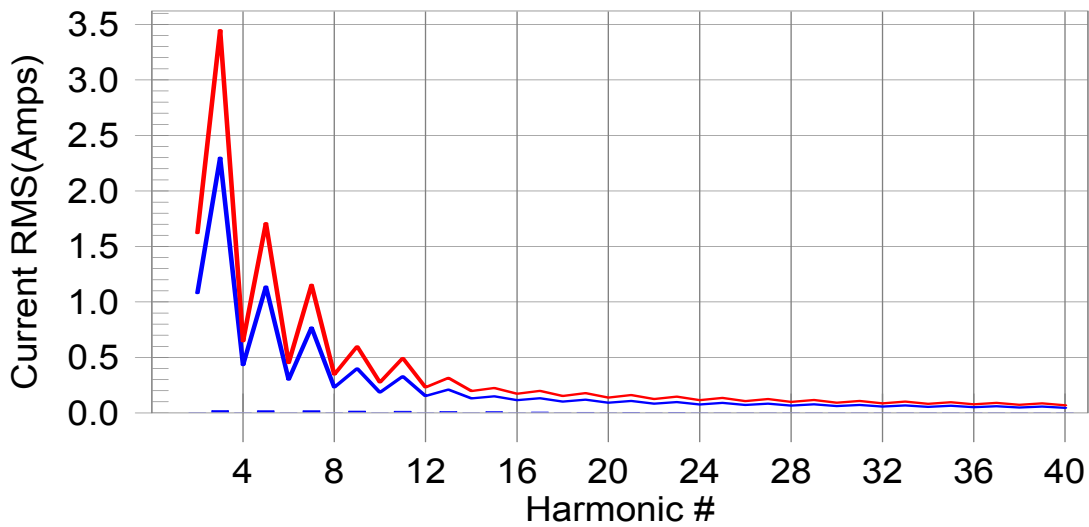

Test result: Pass Worst harmonic was #15 with 6.96% of the limit.

Test Result: Pass Source qualification: Normal

THC(A): 0.05 I-THD(%): 166.83 POHC(A): 0.006 POHC Limit(A): 0.251

Highest parameter values during test:

V_RMS (Volts):	229.48	Frequency(Hz):	50.00
I_Peak (Amps):	0.274	I_RMS (Amps):	0.105
I_Fund (Amps):	0.028	Crest Factor:	2.622
Power (Watts):	5.1	Power Factor:	0.213

Harm#	Harms(avg)	100%Limit	%of Limit	Harms(max)	150%Limit	%of Limit	Status
2	0.000	1.080	0.0	0.000	1.620	0.02	Pass
3	0.022	2.300	0.9	0.022	3.450	0.63	Pass
4	0.000	0.430	0.0	0.000	0.645	0.04	Pass
5	0.020	1.140	1.8	0.021	1.710	1.21	Pass
6	0.000	0.300	0.1	0.000	0.450	0.09	Pass
7	0.019	0.770	2.5	0.019	1.155	1.66	Pass
8	0.000	0.230	0.1	0.000	0.345	0.07	Pass
9	0.017	0.400	4.3	0.017	0.600	2.88	Pass
10	0.000	0.184	0.1	0.000	0.276	0.08	Pass
11	0.015	0.330	4.5	0.015	0.495	3.06	Pass
12	0.000	0.153	0.1	0.000	0.230	0.10	Pass
13	0.013	0.210	6.1	0.013	0.315	4.09	Pass
14	0.000	0.131	0.1	0.000	0.197	0.10	Pass
15	0.010	0.150	7.0	0.011	0.225	4.69	Pass
16	0.000	0.115	0.1	0.000	0.173	0.09	Pass
17	0.008	0.132	6.2	0.008	0.199	4.17	Pass
18	0.000	0.102	0.1	0.000	0.153	0.12	Pass
19	0.006	0.118	5.2	0.006	0.178	3.50	Pass
20	0.000	0.092	0.1	0.000	0.138	0.11	Pass
21	0.004	0.107	4.0	0.004	0.161	2.70	Pass
22	0.000	0.084	0.1	0.000	0.125	0.14	Pass
23	0.003	0.098	2.8	0.003	0.147	1.91	Pass
24	0.000	0.077	0.1	0.000	0.115	0.13	Pass
25	0.001	0.090	1.6	0.002	0.135	1.14	Pass
26	0.000	0.071	0.2	0.000	0.106	0.15	Pass
27	0.001	0.083	0.8	0.001	0.125	0.59	Pass
28	0.000	0.066	0.2	0.000	0.099	0.19	Pass
29	0.001	0.078	0.7	0.001	0.116	0.53	Pass
30	0.000	0.061	0.4	0.000	0.092	0.35	Pass
31	0.001	0.073	1.1	0.001	0.109	0.80	Pass
32	0.000	0.058	0.2	0.000	0.086	0.22	Pass
33	0.001	0.068	1.4	0.001	0.102	1.01	Pass
34	0.000	0.054	0.2	0.000	0.081	0.22	Pass
35	0.001	0.064	1.6	0.001	0.096	1.08	Pass
36	0.000	0.051	0.3	0.000	0.077	0.24	Pass
37	0.001	0.061	1.5	0.001	0.091	1.08	Pass
38	0.000	0.048	0.3	0.000	0.073	0.26	Pass
39	0.001	0.058	1.4	0.001	0.087	0.95	Pass
40	0.000	0.046	0.3	0.000	0.069	0.32	Pass

1.Dynamic limits were applied for this test. The highest harmonics values in the above table may not occur at the same window as the maximum harmonics/limit ratio.

2:According to EN61000-3-2 paragraph 7 the note 1 and 2 are valid for all applications having an active input power >75W. Others the result should be pass.

6.7. Test Photograph

Test Mode : Mode 1: AC 24V

Description : Power Harmonics Test Setup



Test Mode : Mode 2: DC 12V

Description : Power Harmonics Test Setup

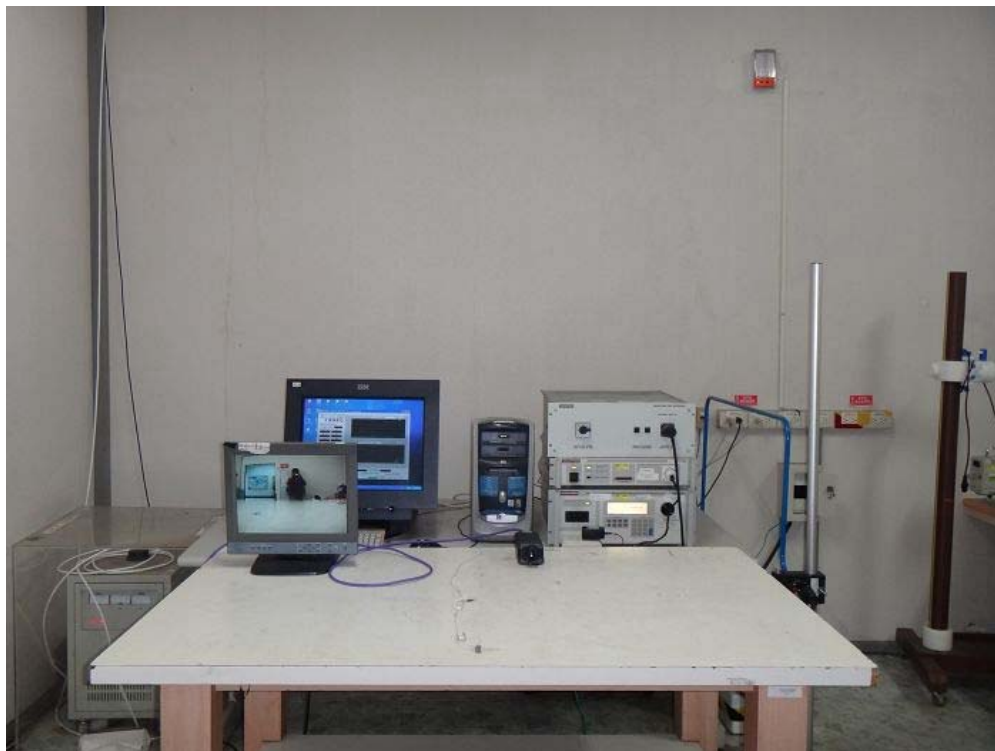

7. Voltage Fluctuation and Flicker

7.1. Test Specification

According to EMC Standard : EN 61000-3-3

7.2. Test Setup

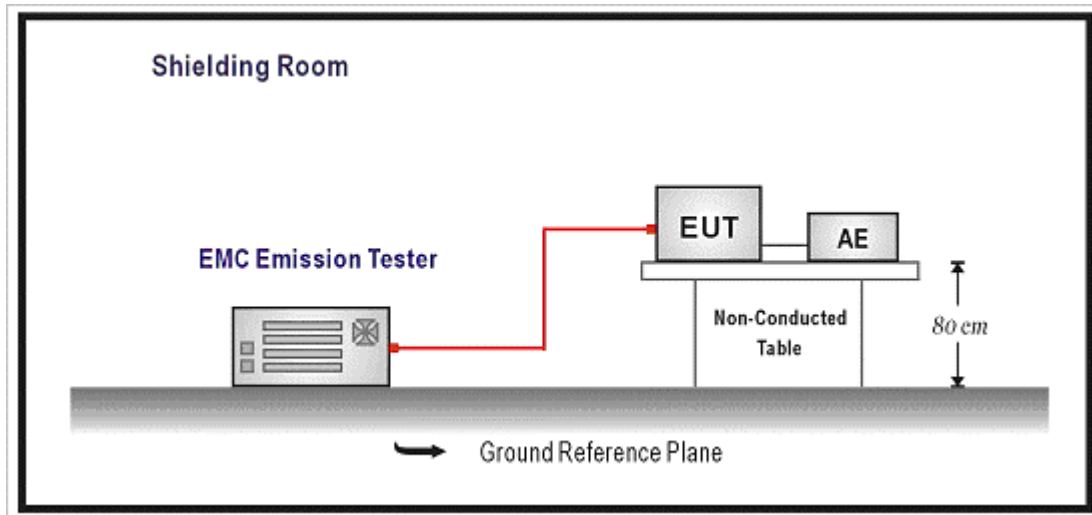

7.3. Limit

The following limits apply:

- the value of P_{st} shall not be greater than 1.0;
- the value of P_{1t} shall not be greater than 0.65;
- the value of $d(t)$ during a voltage change shall not exceed 3.3 % for more than 500 ms;
- the relative steady-state voltage change, d_c , shall not exceed 3.3 %;
- the maximum relative voltage change, d_{max} , shall not exceed;
 - a) 4 % without additional conditions;
 - b) 6 % for equipment which is:
 - switched manually, or
 - switched automatically more frequently than twice per day, and also has either a delayed restart (the delay being not less than a few tens of seconds), or manual restart, after a power supply interruption.

NOTE The cycling frequency will be further limited by the P_{st} and P_{1t} limit.

For example: a d_{max} of 6% producing a rectangular voltage change characteristic twice per hour will give a P_{1t} of about 0.65.

- c) 7 % for equipment which is:
- attended whilst in use (for example: hair dryers, vacuum cleaners, kitchen equipment such as mixers, garden equipment such as lawn mowers, portable tools such as electric drills), or
 - switched on automatically, or is intended to be switched on manually, no more than twice per day, and also has either a delayed restart (the delay being not less than a few tens of seconds) or manual restart, after a power supply interruption.

P_{st} and P_{1t} requirements shall not be applied to voltage changes caused by manual switching.

7.4. Test Procedure

The EUT is supplied in series with power analyzer from a power source having the same normal voltage and frequency as the rated supply voltage and the equipment under test. And the rated voltage at the supply voltage of EUT of 0.94 times and 1.06 times shall be performed.

7.5. Deviation from Test Standard

No deviation.

7.6. Test Result

Product	Network Camera		
Test Item	Voltage Fluctuation and Flicker		
Test Mode	Mode 1: AC 24V		
Date of Test	2012/09/15	Test Site	No.3 Shielded Room

Test Result: Pass

Status: Test Completed

Pst_i and limit line

European Limits

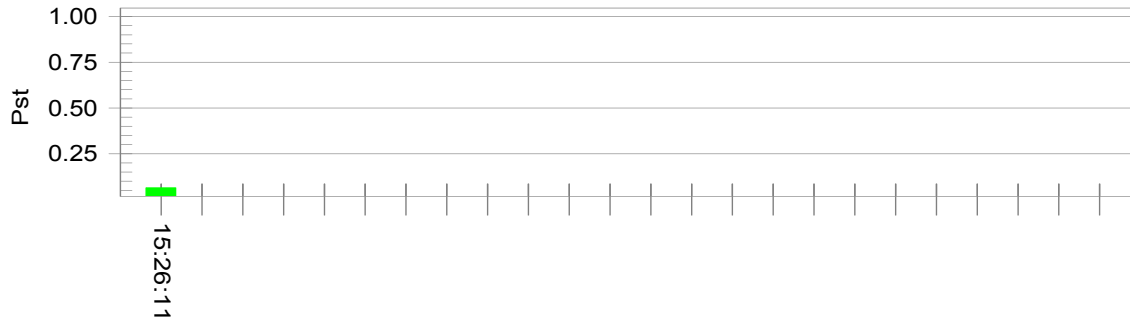

Plt and limit line

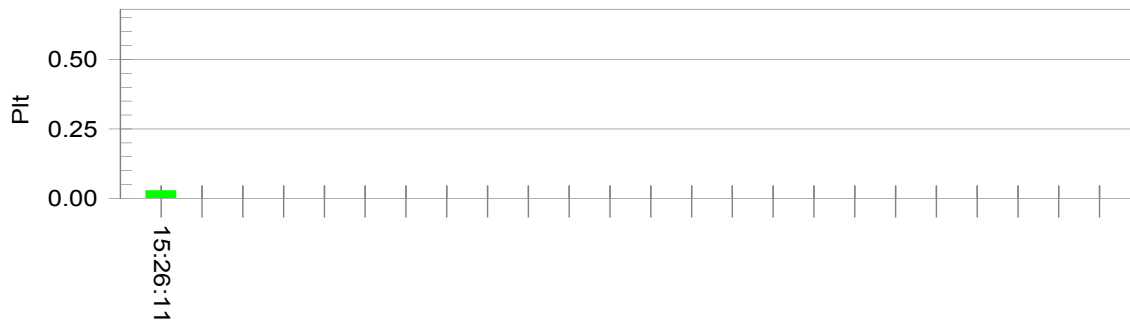

Parameter values recorded during the test:

Vrms at the end of test (Volt):	229.42			
Highest dt (%):	0.00	Test limit (%):	3.30	Pass
Time(mS) > dt:	0.0	Test limit (mS):	500.0	Pass
Highest dc (%):	0.00	Test limit (%):	3.30	Pass
Highest dmax (%):	0.00	Test limit (%):	4.00	Pass
Highest Pst (10 min. period):	0.064	Test limit:	1.000	Pass
Highest Plt (2 hr. period):	0.028	Test limit:	0.650	Pass

Product	Network Camera		
Test Item	Voltage Fluctuation and Flicker		
Test Mode	Mode 2: DC 12V		
Date of Test	2012/09/15	Test Site	No.3 Shielded Room

Test Result: Pass

Status: Test Completed

Pstj and limit line

European Limits

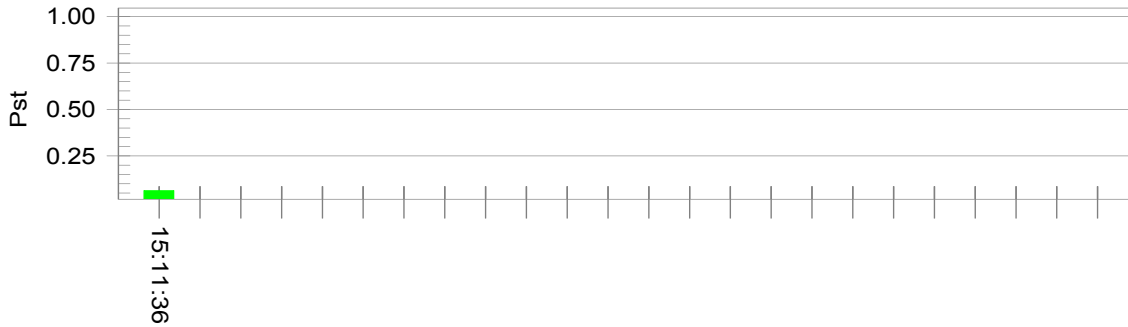

Plt and limit line

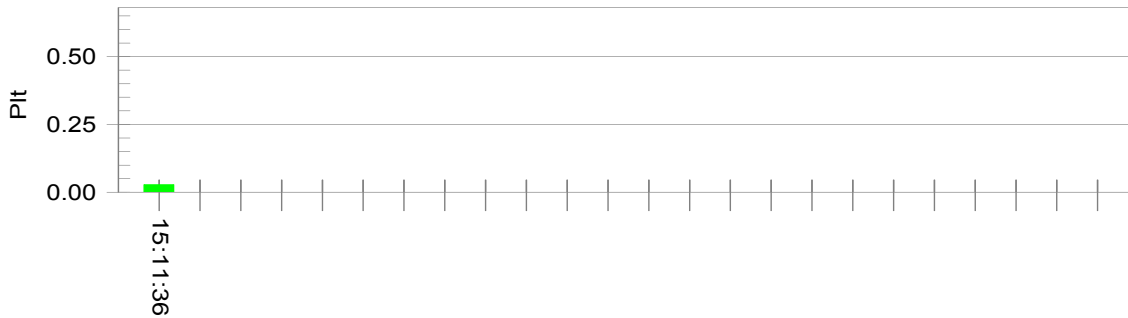

Parameter values recorded during the test:

Vrms at the end of test (Volt):	229.51		
Highest dt (%):	0.00	Test limit (%):	3.30 Pass
Time(mS) > dt:	0.0	Test limit (mS):	500.0 Pass
Highest dc (%):	0.00	Test limit (%):	3.30 Pass
Highest dmax (%):	0.00	Test limit (%):	4.00 Pass
Highest Pst (10 min. period):	0.064	Test limit:	1.000 Pass
Highest Plt (2 hr. period):	0.028	Test limit:	0.650 Pass

7.7. Test Photograph

Test Mode : Mode 1: AC 24V

Description : Flicker Test Setup

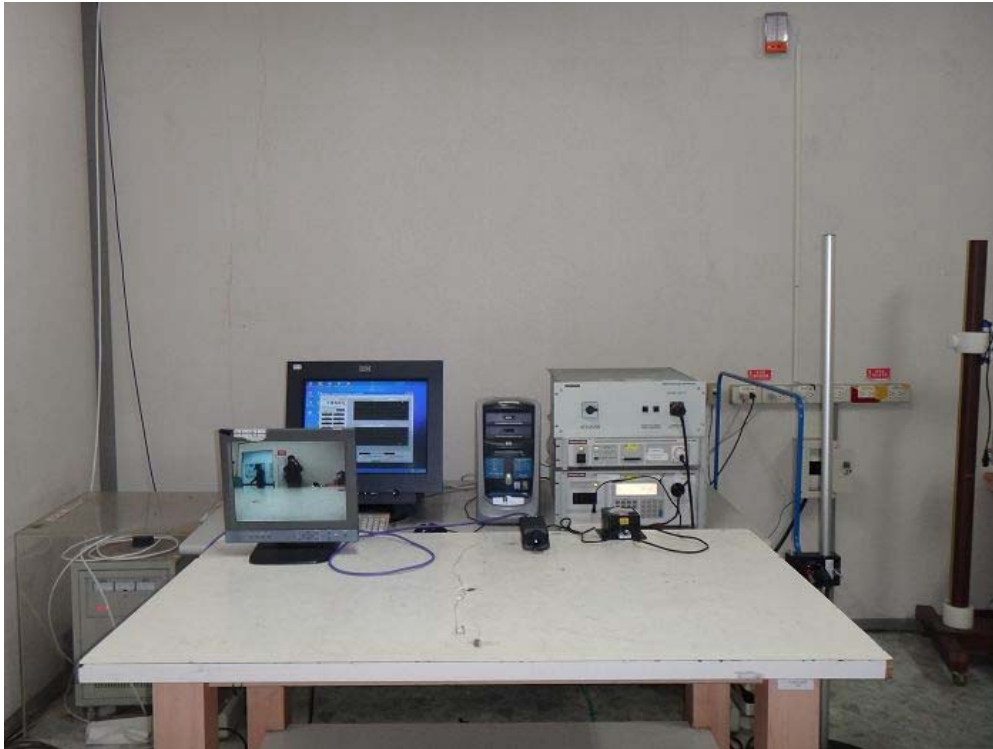

Test Mode : Mode 2: DC 12V

Description : Flicker Test Setup

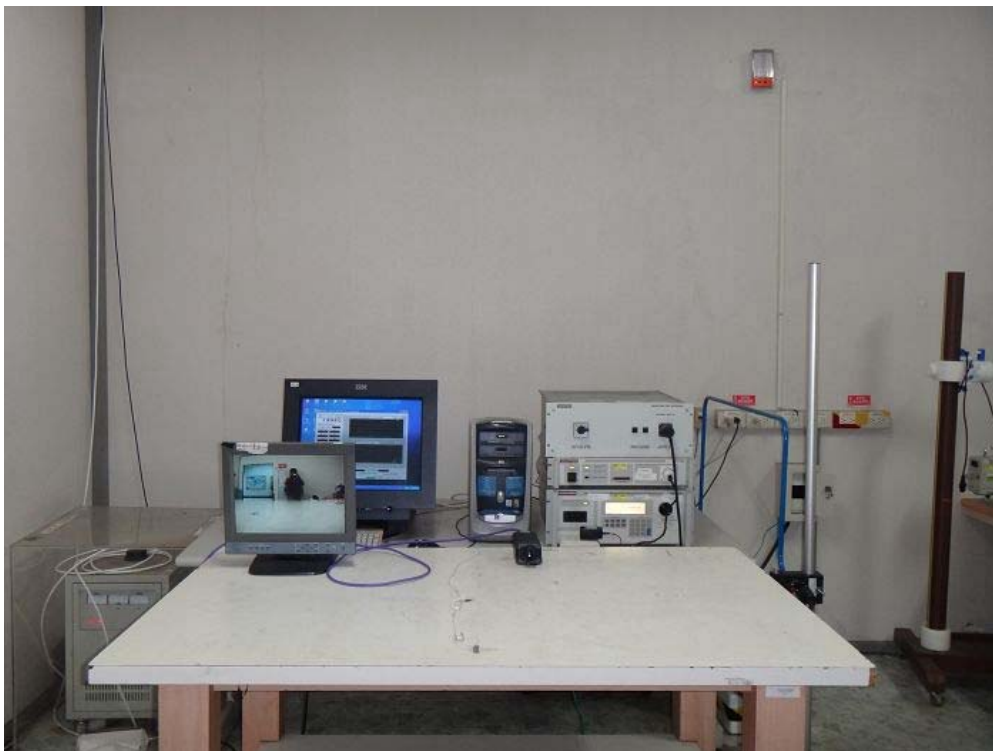

8. Electrostatic Discharge

8.1. Test Specification

According to Standard : IEC 61000-4-2

8.2. Test Setup

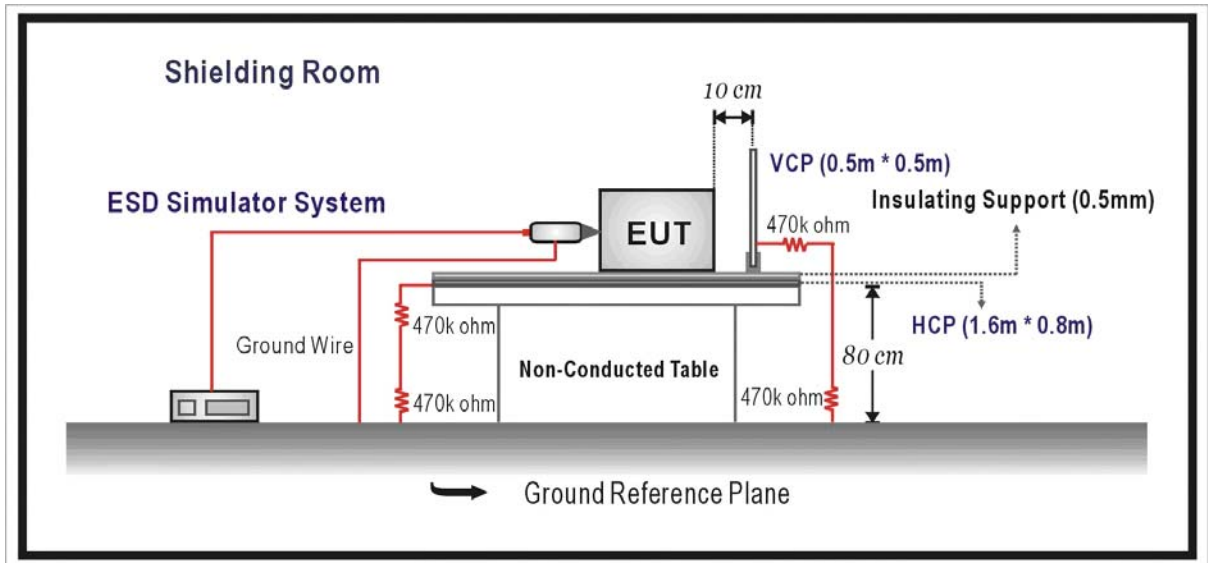

8.3. Limit

Item	Environmental Phenomena	Units	Test Specification	Performance Criteria
Enclosure Port				
	Electrostatic Discharge	kV(Charge Voltage)	±8 Air Discharge ±4 Contact Discharge	B

8.4. Test Procedure

Direct application of discharges to the EUT:

Contact discharge was applied only to conductive surfaces of the EUT.

Air discharges were applied only to non-conductive surfaces of the EUT.

During the test, it was performed with single discharges. For the single discharge time between successive single discharges will be keep longer 1 second. It was at least ten single discharges with positive and negative at the same selected point.

The selected point, which was performed with electrostatic discharge, was marked on the red label of the EUT.

Indirect application of discharges to the EUT:

Vertical Coupling Plane (VCP):

The coupling plane, of dimensions 0.5m x 0.5m, is placed parallel to, and positioned at a distance 0.1m from, the EUT, with the Discharge Electrode touching the coupling plane.

The four faces of the EUT will be performed with electrostatic discharge. It was at least ten single discharges with positive and negative at the same selected point.

Horizontal Coupling Plane (HCP):

The coupling plane is placed under to the EUT. The generator shall be positioned vertically at a distance of 0.1m from the EUT, with the Discharge Electrode touching the coupling plane.

The four faces of the EUT will be performed with electrostatic discharge. It was at least ten single discharges with positive and negative at the same selected point.

8.5. Deviation from Test Standard

No deviation.

8.6. Test Result

Product	Network Camera		
Test Item	Electrostatic Discharge		
Test Mode	Mode 1: AC 24V		
Date of Test	2012/09/18	Test Site	No.6 Shielded Room

Item	Amount of Discharge	Voltage	Required Criteria	Complied To Criteria (A,B,C)	Results
Air Discharge	10	+8kV	B	B	Pass
	10	-8kV	B	B	Pass
Contact Discharge	25	+4kV	B	B	Pass
	25	-4kV	B	B	Pass
Indirect Discharge (HCP)	25	+4kV	B	B	Pass
	25	-4kV	B	B	Pass
Indirect Discharge (VCP)	25	+4kV	B	B	Pass
	25	-4kV	B	B	Pass

Note:

The testing performed is from lowest level up to the highest level as required by standard, but only highest level is shown on the report.

NR: No Requirement

- Meet criteria A: Operate as intended during and after the test
- Meet criteria B: Operate as intended after the test
- Meet criteria C: Loss/Error of function
- Additional Information
 - EUT stopped operation and could / could not be reset by operator at ____ kV.
 - No false alarms or other malfunctions were observed during or after the test.

Remark:

The Contact discharges were applied at least total 200 discharges at a minimum of four test points.

Product	Network Camera		
Test Item	Electrostatic Discharge		
Test Mode	Mode 2: DC 12V		
Date of Test	2012/09/18	Test Site	No.6 Shielded Room

Item	Amount of Discharge	Voltage	Required Criteria	Complied To Criteria (A,B,C)	Results
Air Discharge	10	+8kV	B	B	Pass
	10	-8kV	B	B	Pass
Contact Discharge	25	+4kV	B	B	Pass
	25	-4kV	B	B	Pass
Indirect Discharge (HCP)	25	+4kV	B	B	Pass
	25	-4kV	B	B	Pass
Indirect Discharge (VCP)	25	+4kV	B	B	Pass
	25	-4kV	B	B	Pass

Note:

The testing performed is from lowest level up to the highest level as required by standard, but only highest level is shown on the report.

NR: No Requirement

- Meet criteria A: Operate as intended during and after the test
- Meet criteria B: Operate as intended after the test
- Meet criteria C: Loss/Error of function
- Additional Information
 - EUT stopped operation and could / could not be reset by operator at ____ kV.
 - No false alarms or other malfunctions were observed during or after the test.

Remark:

The Contact discharges were applied at least total 200 discharges at a minimum of four test points.

Product	Network Camera		
Test Item	Electrostatic Discharge		
Test Mode	Mode 3: PoE		
Date of Test	2012/09/18	Test Site	No.6 Shielded Room

Item	Amount of Discharge	Voltage	Required Criteria	Complied To Criteria (A,B,C)	Results
Air Discharge	10	+8kV	B	B	Pass
	10	-8kV	B	B	Pass
Contact Discharge	25	+4kV	B	B	Pass
	25	-4kV	B	B	Pass
Indirect Discharge (HCP)	25	+4kV	B	B	Pass
	25	-4kV	B	B	Pass
Indirect Discharge (VCP)	25	+4kV	B	B	Pass
	25	-4kV	B	B	Pass

Note:

The testing performed is from lowest level up to the highest level as required by standard, but only highest level is shown on the report.

NR: No Requirement

- Meet criteria A: Operate as intended during and after the test
- Meet criteria B: Operate as intended after the test
- Meet criteria C: Loss/Error of function
- Additional Information
 - EUT stopped operation and could / could not be reset by operator at ____ kV.
 - No false alarms or other malfunctions were observed during or after the test.

Remark:

The Contact discharges were applied at least total 200 discharges at a minimum of four test points.

8.7. Test Photograph

Test Mode : Mode 1: AC 24V

Description : ESD Test Setup



Test Mode : Mode 2: DC 12V

Description : ESD Test Setup



Test Mode : Mode 3: PoE
Description : ESD Test Setup



9. Radiated Susceptibility

9.1. Test Specification

According to Standard : IEC 61000-4-3

9.2. Test Setup

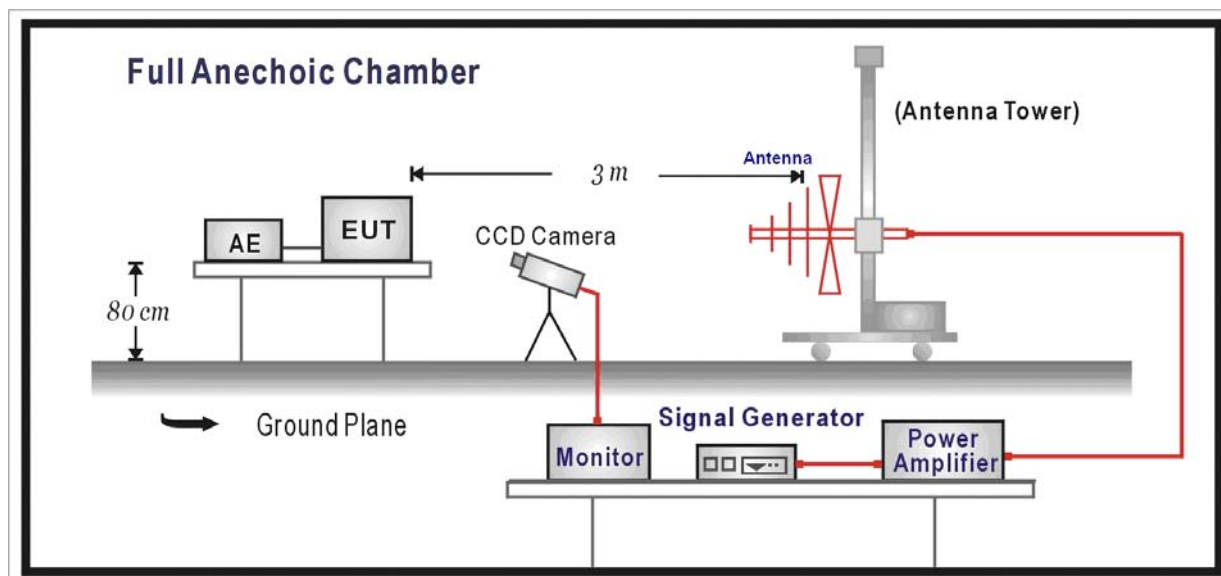

9.3. Limit

Item	Environmental Phenomena	Units	Test Specification	Performance Criteria
Enclosure Port				
	Radio-Frequency	MHz	80-1000	A
	Electromagnetic Field	V/m(Un-modulated, rms)	3	
	Amplitude Modulated	% AM (1kHz)	80	

9.4. Test Procedure

The EUT and load, which are placed on a table that is 0.8 meter above ground, are placed with one coincident with the calibration plane such that the distance from antenna to the EUT was 3 meters.

Both horizontal and vertical polarization of the antenna and four sides of the EUT are set on measurement.

In order to judge the EUT performance, a CCD camera is used to monitor EUT screen.

All the scanning conditions are as follows:

Condition of Test	Remarks
1. Field Strength	3 V/m Level 2
2. Radiated Signal	AM 80% Modulated with 1kHz
3. Scanning Frequency	80MHz - 1000MHz
4. Dwell Time	3 Seconds
5. Frequency step size Δf :	1%
6. The rate of Swept of Frequency	1.5×10^{-3} decades/s

9.5. Deviation from Test Standard

No deviation.

9.6. Test Result

Product	Network Camera		
Test Item	Radiated susceptibility		
Test Mode	Mode 1: AC 24V		
Date of Test	2012/09/18	Test Site	Chamber5

Frequency (MHz)	Position (Angle)	Polarity (H or V)	Field Strength (V/m)	Required Criteria	Complied To Criteria (A, B, C)	Results
80-1000	0°	H	3	A	A	PASS
80-1000	0°	V	3	A	A	PASS
80-1000	90°	H	3	A	A	PASS
80-1000	90°	V	3	A	A	PASS
80-1000	180°	H	3	A	A	PASS
80-1000	180°	V	3	A	A	PASS
80-1000	270°	H	3	A	A	PASS
80-1000	270°	V	3	A	A	PASS

Note:

The testing performed is from lowest level up to the highest level as required by standard, but only highest level is shown on the report.

- Meet criteria A: Operate as intended during and after the test
- Meet criteria B: Operate as intended after the test
- Meet criteria C: Loss/Error of function
- Additional Information
 - There was no observable degradation in performance.
 - EUT stopped operation and could / could not be reset by operator at _____ V/m at frequency _____MHz.
- No false alarms or other malfunctions were observed during or after the test.

Product	Network Camera		
Test Item	Radiated susceptibility		
Test Mode	Mode 2: DC 12V		
Date of Test	2012/09/18	Test Site	Chamber5

Frequency (MHz)	Position (Angle)	Polarity (H or V)	Field Strength (V/m)	Required Criteria	Complied To Criteria (A, B, C)	Results
80-1000	0°	H	3	A	A	PASS
80-1000	0°	V	3	A	A	PASS
80-1000	90°	H	3	A	A	PASS
80-1000	90°	V	3	A	A	PASS
80-1000	180°	H	3	A	A	PASS
80-1000	180°	V	3	A	A	PASS
80-1000	270°	H	3	A	A	PASS
80-1000	270°	V	3	A	A	PASS

Note:

The testing performed is from lowest level up to the highest level as required by standard, but only highest level is shown on the report.

- Meet criteria A: Operate as intended during and after the test
- Meet criteria B: Operate as intended after the test
- Meet criteria C: Loss/Error of function
- Additional Information
 - There was no observable degradation in performance.
 - EUT stopped operation and could / could not be reset by operator at _____ V/m at frequency _____MHz.
- No false alarms or other malfunctions were observed during or after the test.

Product	Network Camera		
Test Item	Radiated susceptibility		
Test Mode	Mode 3: PoE		
Date of Test	2012/09/18	Test Site	Chamber5

Frequency (MHz)	Position (Angle)	Polarity (H or V)	Field Strength (V/m)	Required Criteria	Complied To Criteria (A, B, C)	Results
80-1000	0°	H	3	A	A	PASS
80-1000	0°	V	3	A	A	PASS
80-1000	90°	H	3	A	A	PASS
80-1000	90°	V	3	A	A	PASS
80-1000	180°	H	3	A	A	PASS
80-1000	180°	V	3	A	A	PASS
80-1000	270°	H	3	A	A	PASS
80-1000	270°	V	3	A	A	PASS

Note:

The testing performed is from lowest level up to the highest level as required by standard, but only highest level is shown on the report.

- Meet criteria A: Operate as intended during and after the test
- Meet criteria B: Operate as intended after the test
- Meet criteria C: Loss/Error of function
- Additional Information
 - There was no observable degradation in performance.
 - EUT stopped operation and could / could not be reset by operator at _____ V/m at frequency _____MHz.
- No false alarms or other malfunctions were observed during or after the test.

9.7. Test Photograph

Test Mode : Mode 1: AC 24V

Description : Radiated Susceptibility Test Setup

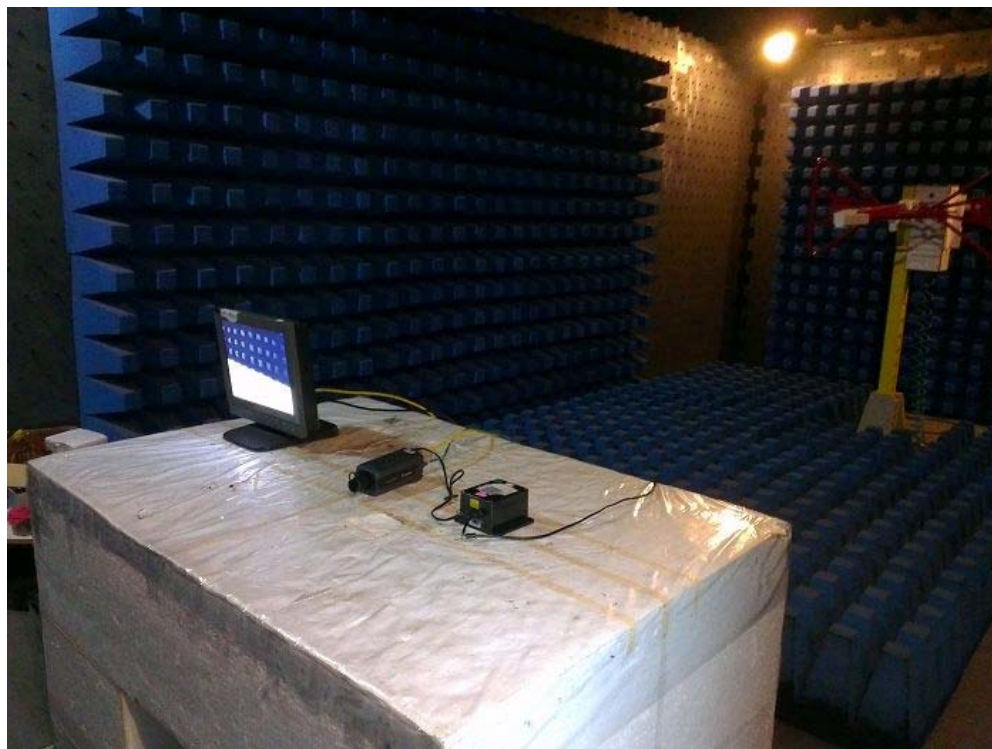

Test Mode : Mode 1: AC 24V

Description : Radiated Susceptibility Test Setup

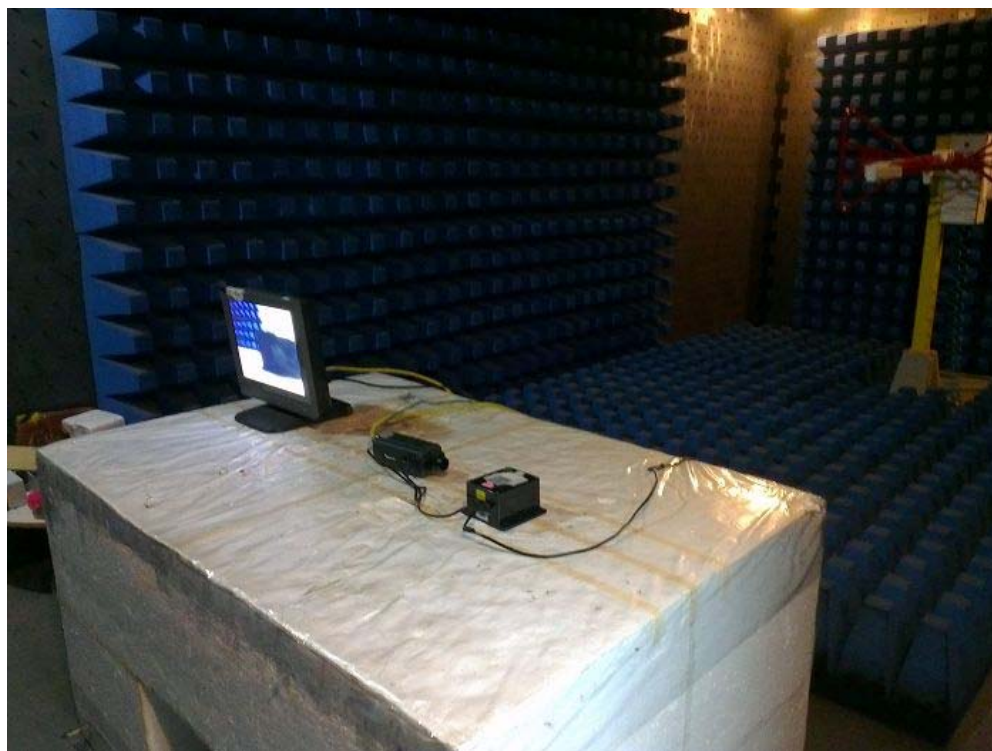

Test Mode : Mode 1: AC 24V

Description : Radiated Susceptibility Test Setup



Test Mode : Mode 1: AC 24V

Description : Radiated Susceptibility Test Setup

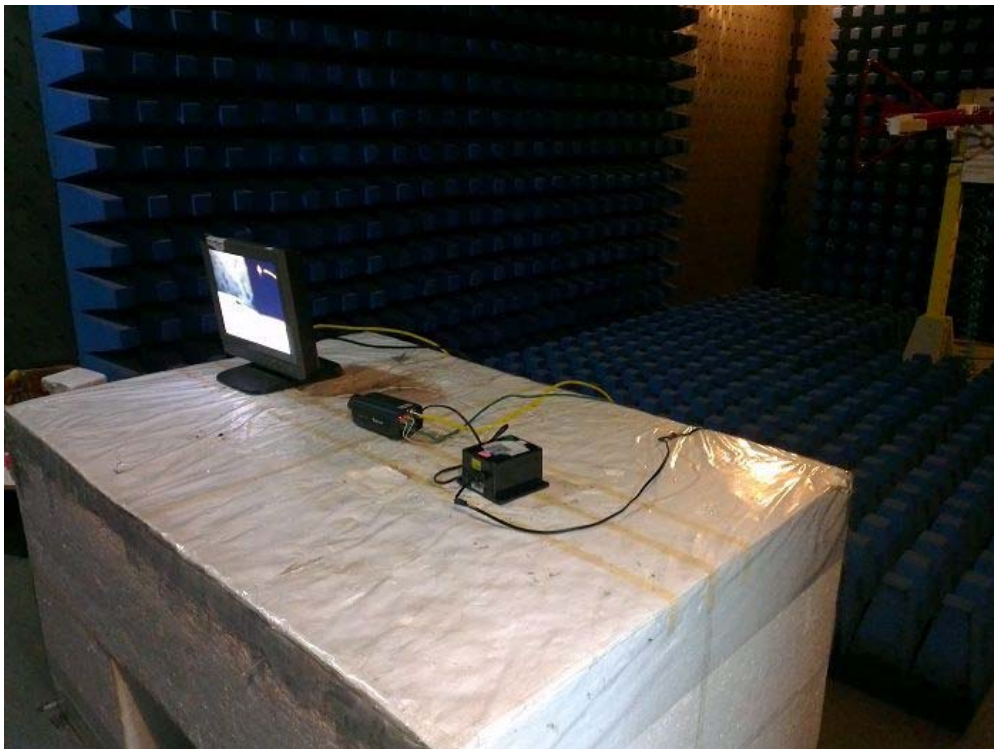

Test Mode : Mode 1: AC 24V

Description : Radiated Susceptibility Test Setup

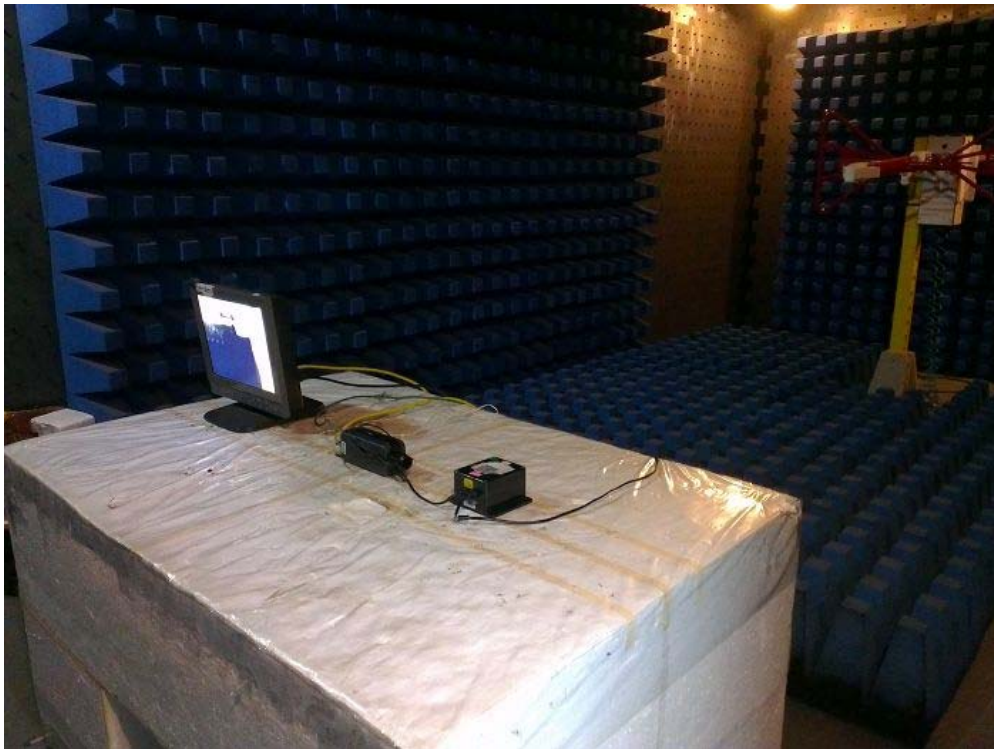

Test Mode : Mode 1: AC 24V

Description : Radiated Susceptibility Test Setup

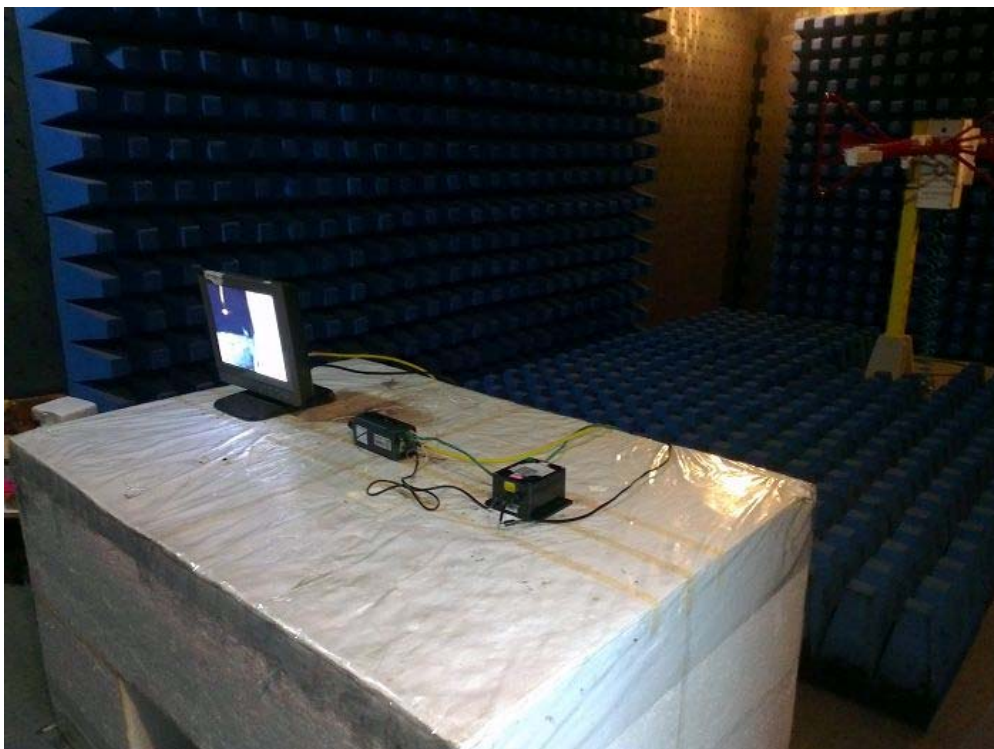

Test Mode : Mode 2: DC 12V

Description : Radiated Susceptibility Test Setup



Test Mode : Mode 2: DC 12V

Description : Radiated Susceptibility Test Setup

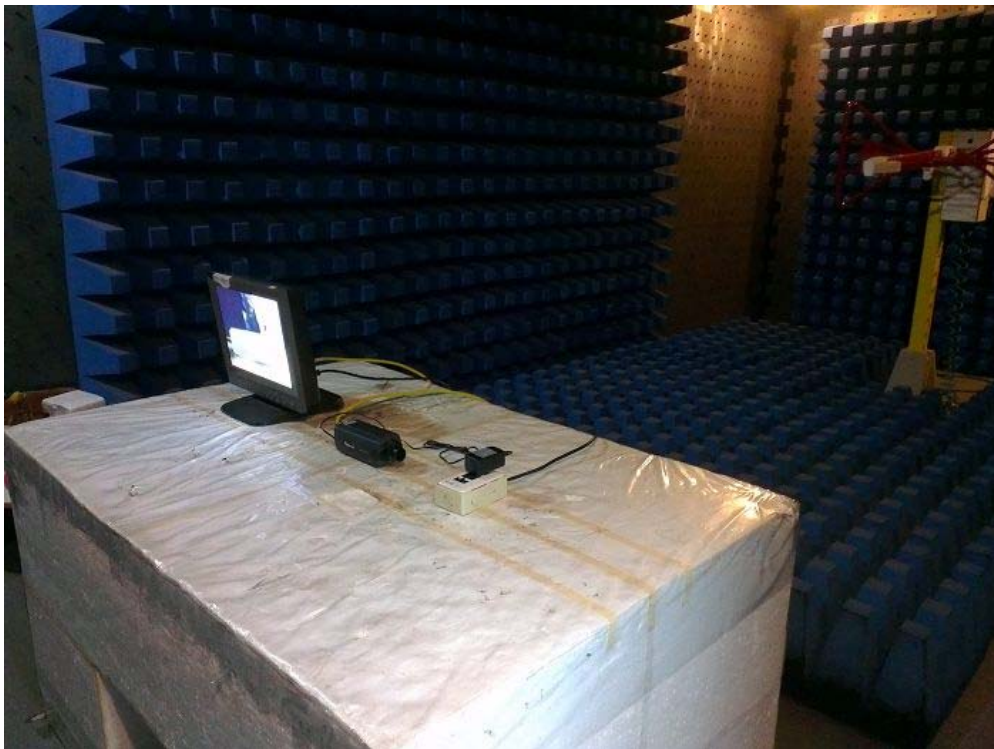

Test Mode : Mode 2: DC 12V

Description : Radiated Susceptibility Test Setup



Test Mode : Mode 2: DC 12V

Description : Radiated Susceptibility Test Setup

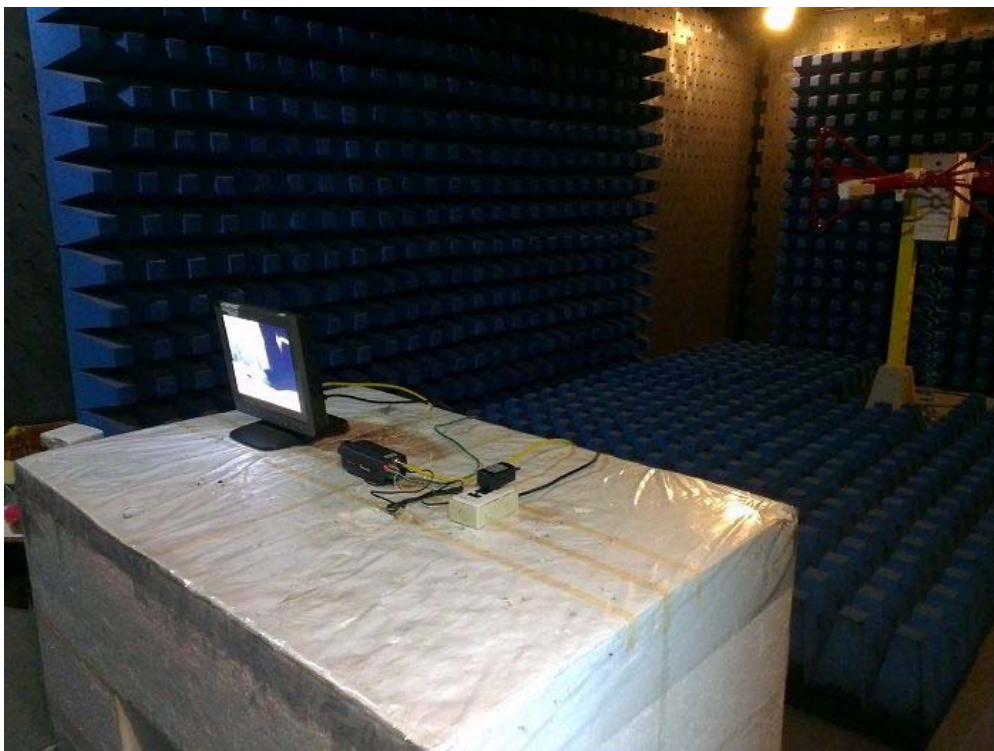

Test Mode : Mode 2: DC 12V

Description : Radiated Susceptibility Test Setup

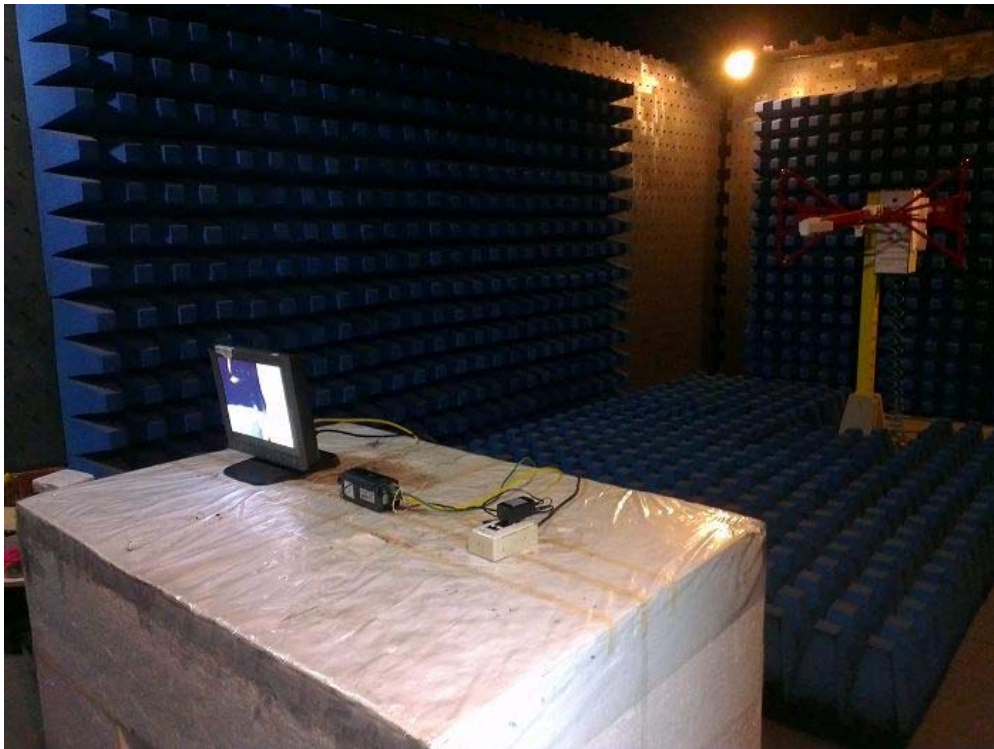

Test Mode : Mode 2: DC 12V

Description : Radiated Susceptibility Test Setup



Test Mode : Mode 3: PoE

Description : Radiated Susceptibility Test Setup



Test Mode : Mode 3: PoE

Description : Radiated Susceptibility Test Setup



Test Mode : Mode 3: PoE

Description : Radiated Susceptibility Test Setup



Test Mode : Mode 3: PoE

Description : Radiated Susceptibility Test Setup

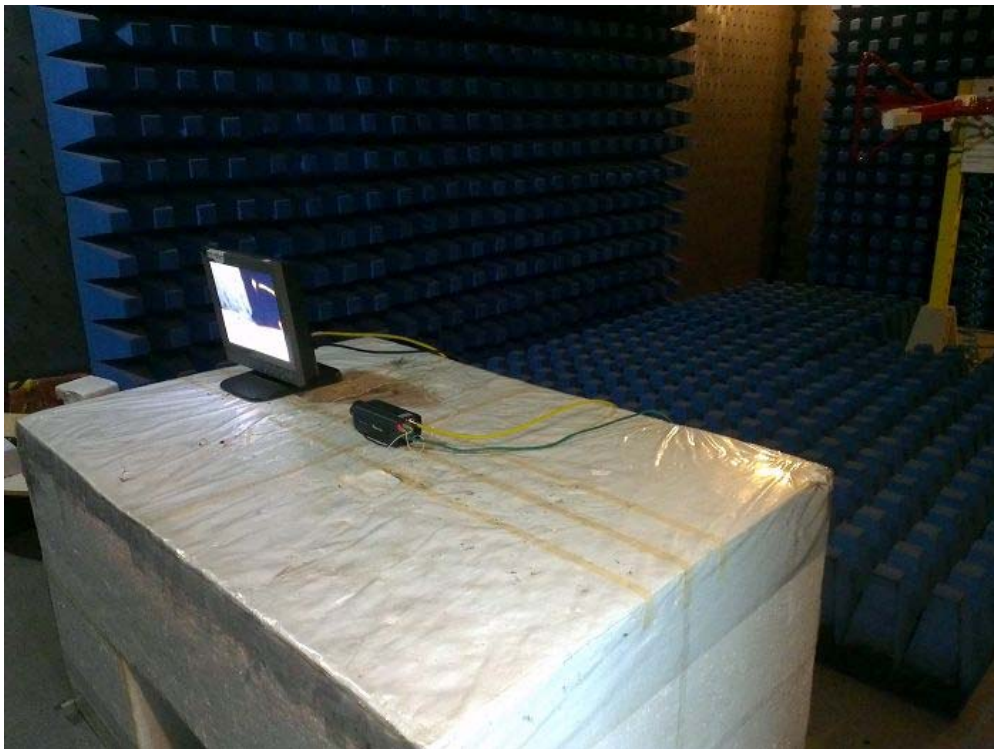

Test Mode : Mode 3: PoE

Description : Radiated Susceptibility Test Setup



Test Mode : Mode 3: PoE

Description : Radiated Susceptibility Test Setup



10. Electrical Fast Transient/Burst

10.1. Test Specification

According to Standard : IEC 61000-4-4

10.2. Test Setup

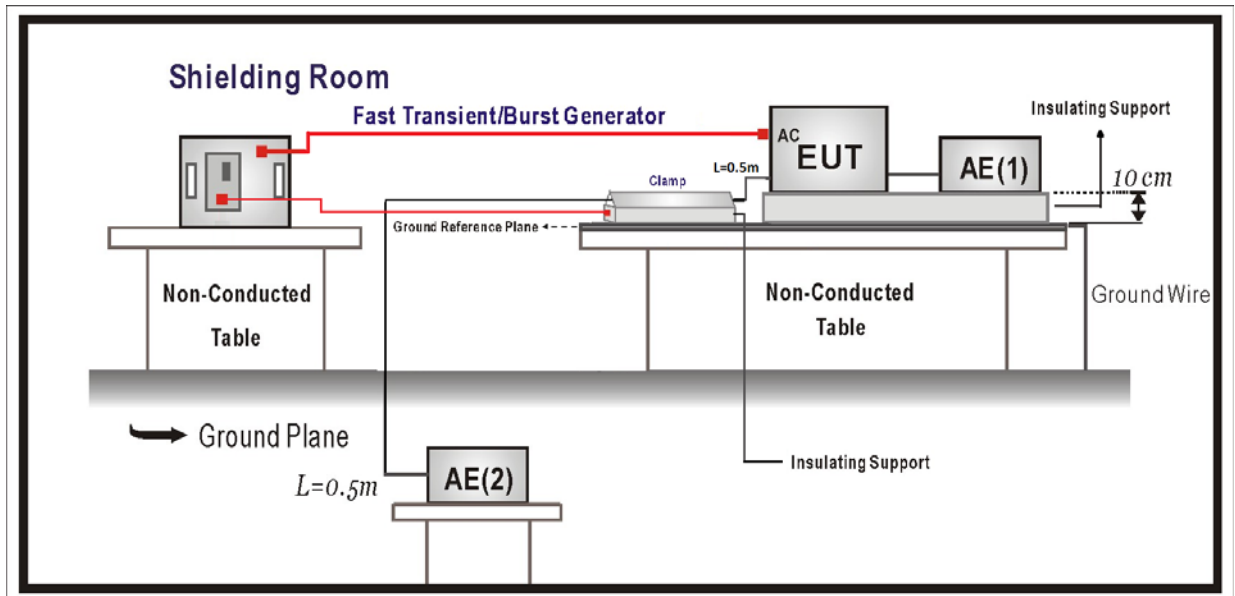

10.3. Limit

Item	Environmental Phenomena	Units	Test Specification	Performance Criteria
I/O and communication ports				
	Fast Transients Common Mode	kV (Peak) Tr/Th ns Rep. Frequency kHz	+0.5 5/50 5	B
Input DC Power Ports				
	Fast Transients Common Mode	kV (Peak) Tr/Th ns Rep. Frequency kHz	+0.5 5/50 5	B
Input AC Power Ports				
	Fast Transients Common Mode	kV (Peak) Tr/Th ns Rep. Frequency kHz	+1 5/50 5	B

10.4. Test Procedure

The EUT is placed on a table that is 0.8 meter height. A ground reference plane is placed on the table, and uses a 0.1m insulation between the EUT and ground reference plane.

The minimum area of the ground reference plane is 1m*1m, and 0.65mm thick min, and projected beyond the EUT by at least 0.1m on all sides.

Test on I/O and communication ports:

The EFT interference signal is through a coupling clamp device couples to the signal and control lines of the EUT with burst noise for 1 minute.

Test on power supply ports:

The EUT is connected to the power mains through a coupling device that directly couples the EFT/B interference signal.

Each of the Line and Neutral conductors is impressed with burst noise for 1 minute.

The length of the signal and power lines between the coupling device and the EUT is 0.5m.

10.5. Deviation from Test Standard

No deviation.

10.6. Test Result

Product	Network Camera		
Test Item	Electrical fast transient/burst		
Test Mode	Mode 1: AC 24V		
Date of Test	2012/09/18	Test Site	No.3 Shielded Room

Inject Line	Polarity	Voltage kV	Inject Time (Second)	Inject Method	Required Criteria	Complied to Criteria	Result
L-N	±	1kV	60	Direct	B	A	PASS
LAN	±	0.5kV	60	Clamp	B	A	PASS
Coaxial	±	0.5kV	60	Clamp	B	A	PASS

Note:

The testing performed is from lowest level up to the highest level as required by standard, but only highest level is shown on the report.

- Meet criteria A : Operate as intended during and after the test
- Meet criteria B : Operate as intended after the test
- Meet criteria C : Loss/Error of function
- Additional Information
 - EUT stopped operation and could / could not be reset by operator at _____ kV of Line _____.
- No false alarms or other malfunctions were observed during or after the test.

Product	Network Camera		
Test Item	Electrical fast transient/burst		
Test Mode	Mode 2: DC 12V		
Date of Test	2012/09/18	Test Site	No.3 Shielded Room

Inject Line	Polarity	Voltage kV	Inject Time (Second)	Inject Method	Required Criteria	Complied to Criteria	Result
L-N	±	1kV	60	Direct	B	A	PASS
LAN	±	0.5kV	60	Clamp	B	A	PASS
Coaxial	±	0.5kV	60	Clamp	B	A	PASS

Note:

The testing performed is from lowest level up to the highest level as required by standard, but only highest level is shown on the report.

- Meet criteria A : Operate as intended during and after the test
- Meet criteria B : Operate as intended after the test
- Meet criteria C : Loss/Error of function
- Additional Information
 - EUT stopped operation and could / could not be reset by operator at _____ kV of Line _____.
- No false alarms or other malfunctions were observed during or after the test.

Product	Network Camera		
Test Item	Electrical fast transient/burst		
Test Mode	Mode 3: PoE		
Date of Test	2012/09/18	Test Site	No.3 Shielded Room

Inject Line	Polarity	Voltage kV	Inject Time (Second)	Inject Method	Required Criteria	Complied to Criteria	Result
LAN	±	0.5kV	60	Clamp	B	A	PASS
Coaxial	±	0.5kV	60	Clamp	B	A	PASS

Note:

The testing performed is from lowest level up to the highest level as required by standard, but only highest level is shown on the report.

- Meet criteria A : Operate as intended during and after the test
- Meet criteria B : Operate as intended after the test
- Meet criteria C : Loss/Error of function
- Additional Information
 - EUT stopped operation and could / could not be reset by operator at _____ kV of Line _____.
- No false alarms or other malfunctions were observed during or after the test.

10.7. Test Photograph

Test Mode : Mode 1: AC 24V

Description : EFT/B Test Setup



Test Mode : Mode 1: AC 24V

Description : EFT/B Test Setup-Clamp



Test Mode : Mode 2: DC 12V
Description : EFT/B Test Setup



Test Mode : Mode 2: DC 12V
Description : EFT/B Test Setup-Clamp



Test Mode : Mode 3: PoE
Description : EFT/B Test Setup-Clamp



11. Surge

11.1. Test Specification

According to Standard : IEC 61000-4-5

11.2. Test Setup

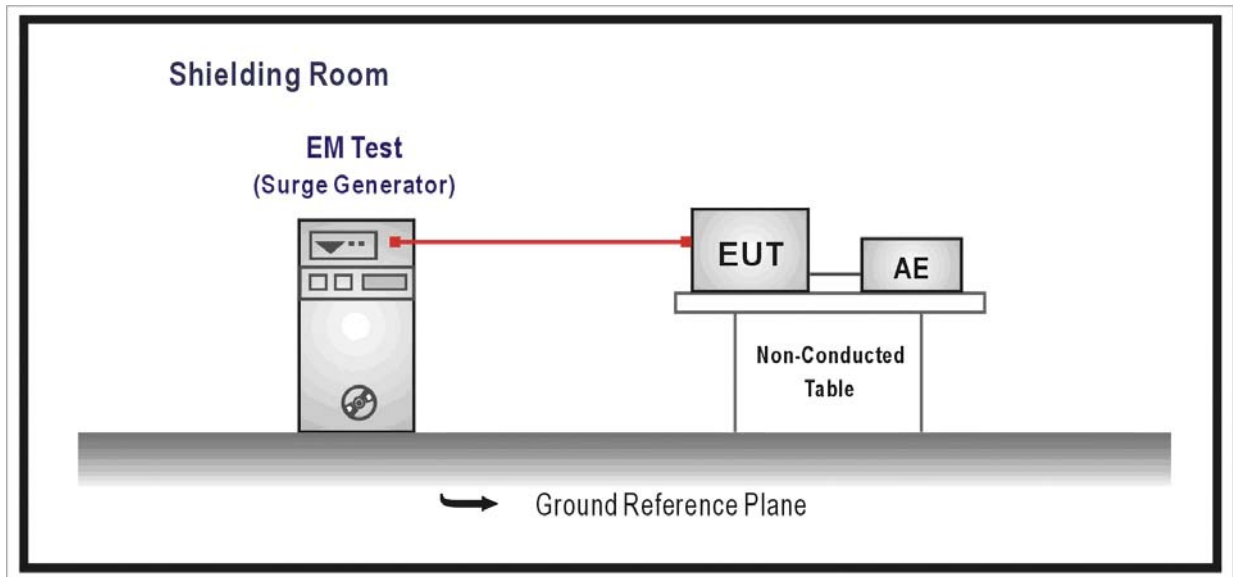

11.3. Limit

Item	Environmental Phenomena	Units	Test Specification	Performance Criteria
Signal Ports and Telecommunication Ports(See 1) and 2))				
	Surges Line to Ground	Tr/Th us kV	10/700 ± 1	C
Input DC Power Ports				
	Surges Line to Ground	Tr/Th us kV	1.2/50 (8/20) ± 0.5	B
AC Input and AC Output Power Ports				
	Surges Line to Line Line to Ground	Tr/Th us kV kV	1.2/50 (8/20) ± 1 ± 2	B

Notes:

- 1) Applicable only to ports which according to the manufacturer’s may directly to outdoor cables.
- 2) Where normal functioning cannot be achieved because of the impact of the CDN on the EUT, no immunity test shall be required.

11.4. Test Procedure

The EUT and its load are placed on a table that is 0.8 meter above a metal ground plane measured 1m*1m min. and 0.65mm thick min. And projected beyond the EUT by at least 0.1m on all sides. The length of power cord between the coupling device and the EUT shall be 2m or less.

For Input and Output AC Power or DC Input and DC Output Power Ports:

The EUT is connected to the power mains through a coupling device that directly couples the Surge interference signal.

The surge noise shall be applied synchronized to the voltage phase at 0° , 90° , 180° , 270° and the peak value of the a.c. voltage wave. (Positive and negative)

Each of Line-Earth and Line-Line is impressed with a sequence of five surge voltages with interval of 1 min.

11.5. Deviation from Test Standard

No deviation.

11.6. Test Result

Product	Network Camera		
Test Item	Surge		
Test Mode	Mode 1: AC 24V		
Date of Test	2012/09/18	Test Site	No.3 Shielded Room

Inject Line	Polarity	Voltage kV	Angle	Time Interval (Second)	Inject Method	Required Criteria	Complied to Criteria	Result
L-N	±	1kV	0	60	Direct	B	A	PASS
L-N	±	1kV	90	60	Direct	B	A	PASS
L-N	±	1kV	180	60	Direct	B	A	PASS
L-N	±	1kV	270	60	Direct	B	A	PASS

Note:

The testing performed is from lowest level up to the highest level as required by standard, but only highest level is shown on the report.

- Meet criteria A : Operate as intended during and after the test
- Meet criteria B : Operate as intended after the test
- Meet criteria C : Loss/Error of function
- Additional Information
 - EUT stopped operation and could / could not be reset by operator at _____ kV of Line _____.
- No false alarms or other malfunctions were observed during or after the test.

Product	Network Camera		
Test Item	Surge		
Test Mode	Mode 2: DC 12V		
Date of Test	2012/09/18	Test Site	No.3 Shielded Room

Inject Line	Polarity	Voltage kV	Angle	Time Interval (Second)	Inject Method	Required Criteria	Complied to Criteria	Result
L-N	±	1kV	0	60	Direct	B	A	PASS
L-N	±	1kV	90	60	Direct	B	A	PASS
L-N	±	1kV	180	60	Direct	B	A	PASS
L-N	±	1kV	270	60	Direct	B	A	PASS

Note:

The testing performed is from lowest level up to the highest level as required by standard, but only highest level is shown on the report.

- Meet criteria A : Operate as intended during and after the test
- Meet criteria B : Operate as intended after the test
- Meet criteria C : Loss/Error of function
- Additional Information
 - EUT stopped operation and could / could not be reset by operator at _____ kV of Line _____.
- No false alarms or other malfunctions were observed during or after the test.

11.7. Test Photograph

Test Mode : Mode 1: AC 24V

Description : SURGE Test Setup



Test Mode : Mode 2: DC 12V

Description : SURGE Test Setup



12. Conducted Susceptibility

12.1. Test Specification

According to Standard : IEC 61000-4-6

12.2. Test Setup

CDN Inject Method

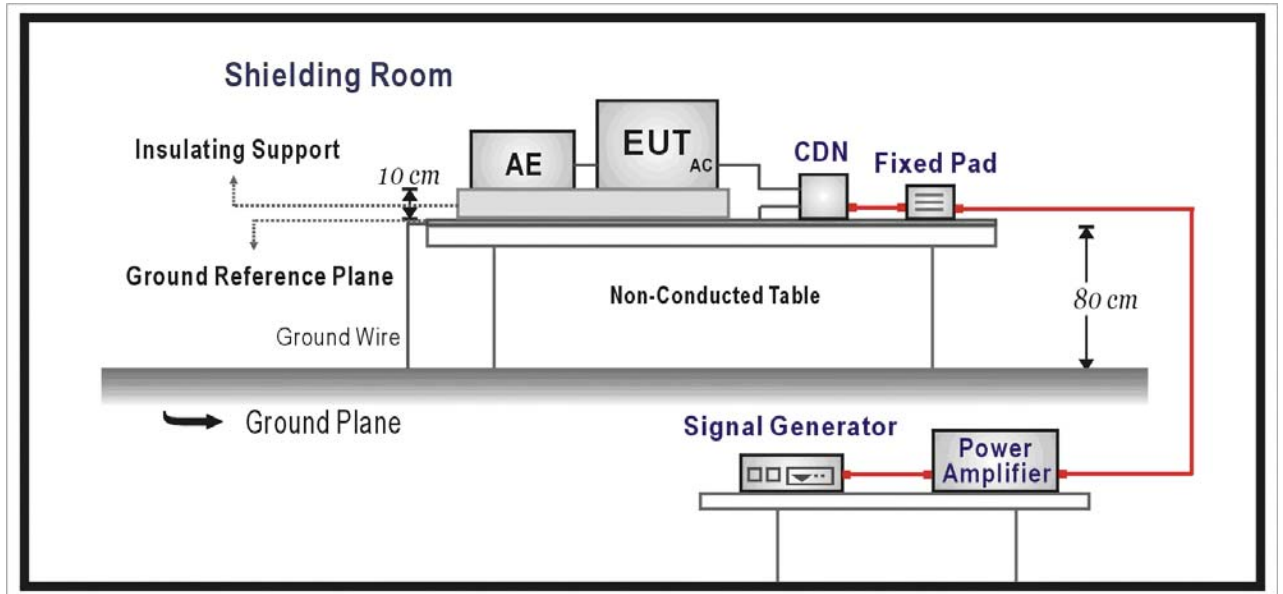

EM Clamp Inject Method

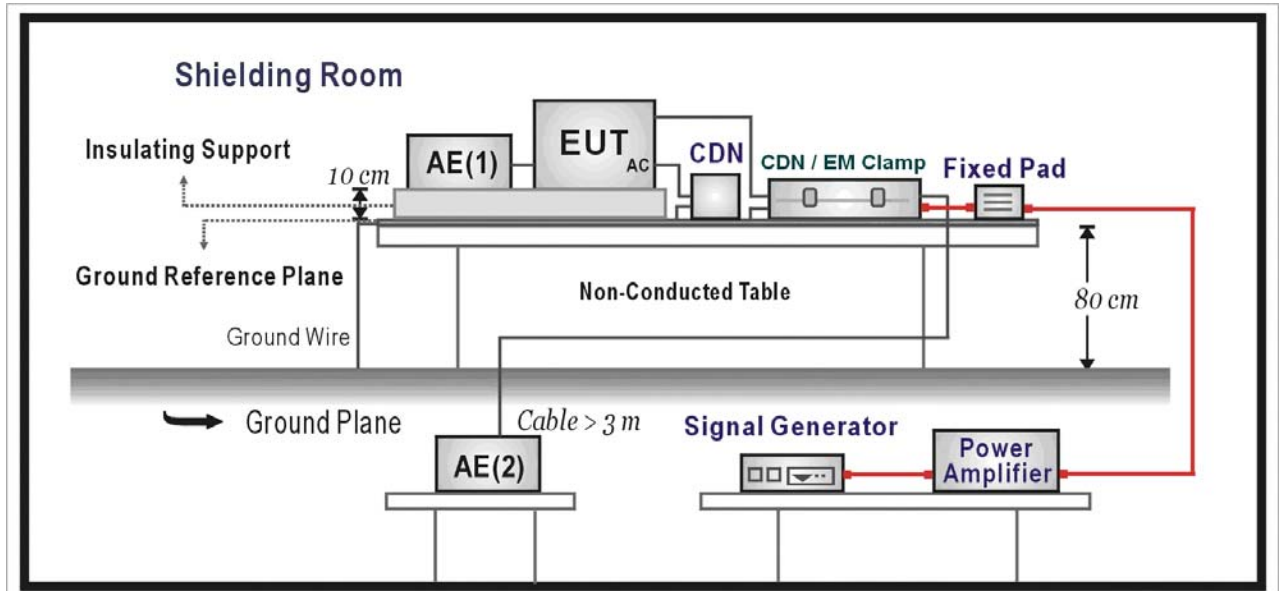

12.3. Limit

Item	Environmental Phenomena	Units	Test Specification	Performance Criteria
Signal Ports and Telecommunication Ports				
	Radio-Frequency Continuous Conducted	MHz V (rms, Un-modulated) % AM (1kHz)	0.15-80 3 80	A
Input DC Power Ports				
	Radio-Frequency Continuous Conducted	MHz V (rms, Un-modulated) % AM (1kHz)	0.15-80 3 80	A
Input AC Power Ports				
	Radio-Frequency Continuous Conducted	MHz V (rms, Un-modulated) % AM (1kHz)	0.15-80 3 80	A

12.4. Test Procedure

The EUT are placed on a table that is 0.8 meter height, and a Ground reference plane on the table, EUT are placed upon table and use a 10cm insulation between the EUT and Ground reference plane.

For Signal Ports and Telecommunication Ports

The disturbance signal is through a coupling and decoupling networks (CDN) or EM-clamp device couples to the signal and Telecommunication lines of the EUT.

For Input DC and AC Power Ports

The EUT is connected to the power mains through a coupling and decoupling networks for power supply lines. And directly couples the disturbances signal into EUT.

Used CDN-M2 for two wires or CDN-M3 for three wires.

All the scanning conditions are as follows:

Condition of Test	Remarks
1. Field Strength	130dBuV(3V) Level 2
2. Radiated Signal	AM 80% Modulated with 1kHz
3. Scanning Frequency	0.15MHz – 80MHz
4. Dwell Time	3 Seconds
5. Frequency step size Δf :	1%
6. The rate of Swept of Frequency	1.5×10^{-3} decades/s

12.5. Deviation from Test Standard

No deviation.

12.6. Test Result

Product	Network Camera		
Test Item	Conducted susceptibility		
Test Mode	Mode 1: AC 24V		
Date of Test	2012/09/18	Test Site	No.6 Shielded Room

Frequency Range (MHz)	Voltage Applied dBuV(V)	Inject Method	Tested Port of EUT	Required Criteria	Performance Criteria Complied To	Result
0.15~80	130 (3V)	CDN	AC IN	A	A	PASS
0.15~80	130 (3V)	CDN	LAN	A	A	PASS
0.15~80	130 (3V)	Clamp	Coaxial	A	A	PASS

Note:

The testing performed is from lowest level up to the highest level as required by standard, but only highest level is shown on the report.

- Meet criteria A : Operate as intended during and after the test
- Meet criteria B : Operate as intended after the test
- Meet criteria C : Loss/Error of function
- Additional Information
 - EUT stopped operation and could / could not be reset by operator at _____ dBuV(V) at frequency _____MHz.
 - No false alarms or other malfunctions were observed during or after the test. The acceptance criteria were met, and the EUT passed the test.

Product	Network Camera		
Test Item	Conducted susceptibility		
Test Mode	Mode 2: DC 12V		
Date of Test	2012/09/18	Test Site	No.6 Shielded Room

Frequency Range (MHz)	Voltage Applied dBuV(V)	Inject Method	Tested Port of EUT	Required Criteria	Performance Criteria Complied To	Result
0.15~80	130 (3V)	CDN	DC IN	A	A	PASS
0.15~80	130 (3V)	CDN	LAN	A	A	PASS
0.15~80	130 (3V)	Clamp	Coaxial	A	A	PASS

Note:

The testing performed is from lowest level up to the highest level as required by standard, but only highest level is shown on the report.

- Meet criteria A : Operate as intended during and after the test
- Meet criteria B : Operate as intended after the test
- Meet criteria C : Loss/Error of function
- Additional Information
 - EUT stopped operation and could / could not be reset by operator at _____ dBuV(V) at frequency _____MHz.
 - No false alarms or other malfunctions were observed during or after the test. The acceptance criteria were met, and the EUT passed the test.

Product	Network Camera		
Test Item	Conducted susceptibility		
Test Mode	Mode 3: PoE		
Date of Test	2012/09/18	Test Site	No.6 Shielded Room

Frequency Range (MHz)	Voltage Applied dBuV(V)	Inject Method	Tested Port of EUT	Required Criteria	Performance Criteria Complied To	Result
0.15~80	130 (3V)	Clamp	LAN	A	A	PASS
0.15~80	130 (3V)	Clamp	Coaxial	A	A	PASS

Note:

The testing performed is from lowest level up to the highest level as required by standard, but only highest level is shown on the report.

- Meet criteria A : Operate as intended during and after the test
- Meet criteria B : Operate as intended after the test
- Meet criteria C : Loss/Error of function
- Additional Information
 - EUT stopped operation and could / could not be reset by operator at ____ dBuV(V) at frequency ____MHz.
 - No false alarms or other malfunctions were observed during or after the test. The acceptance criteria were met, and the EUT passed the test.

12.7. Test Photograph

Test Mode : Mode 1: AC 24V

Description : Conducted Susceptibility Test Setup



Test Mode : Mode 1: AC 24V

Description : Conducted Susceptibility Test Setup-Clamp

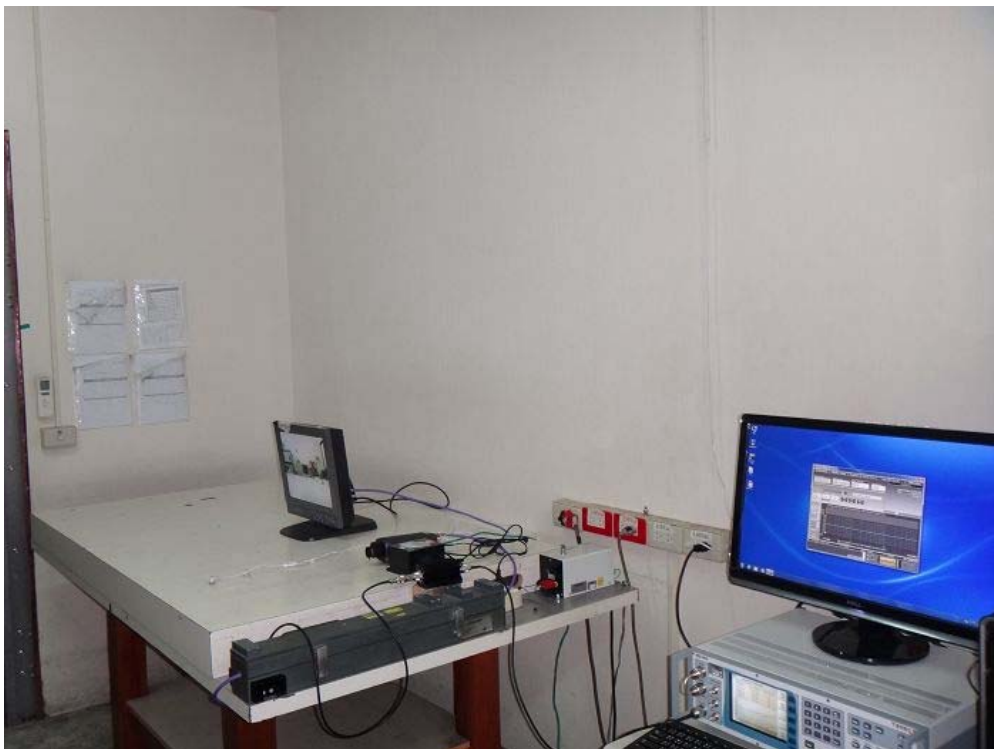

Test Mode : Mode 2: DC 12V

Description : Conducted Susceptibility Test Setup



Test Mode : Mode 2: DC 12V

Description : Conducted Susceptibility Test Setup-Clamp

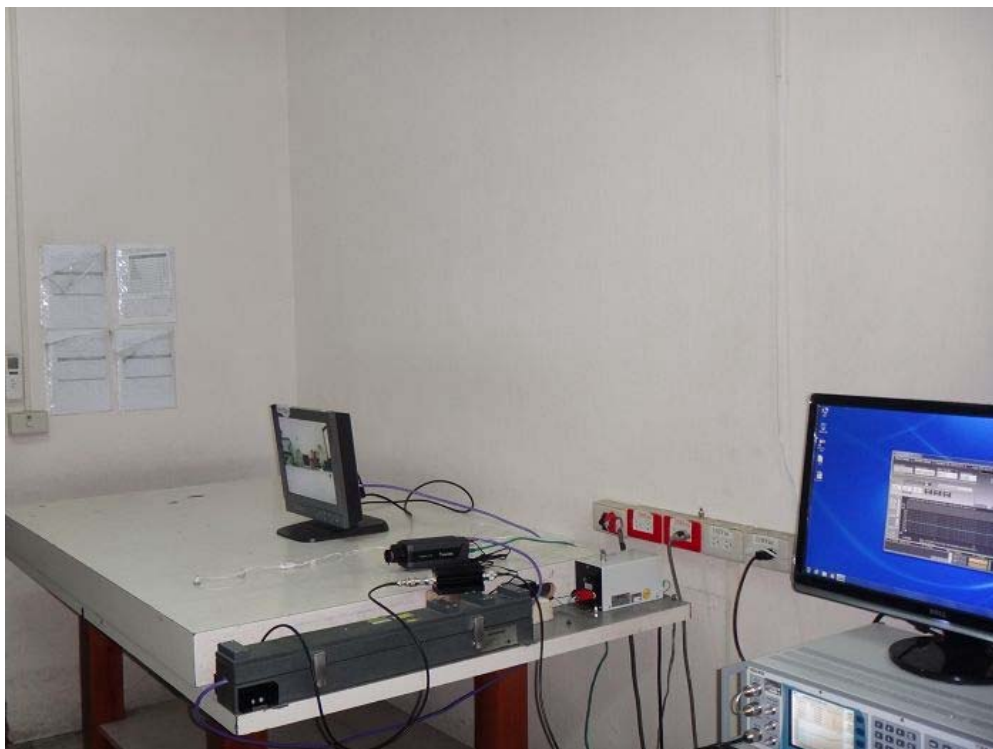

Test Mode : Mode 3: PoE

Description : Conducted Susceptibility Test Setup-Clamp



13. Power Frequency Magnetic Field

13.1. Test Specification

According to Standard : IEC 61000-4-8

13.2. Test Setup

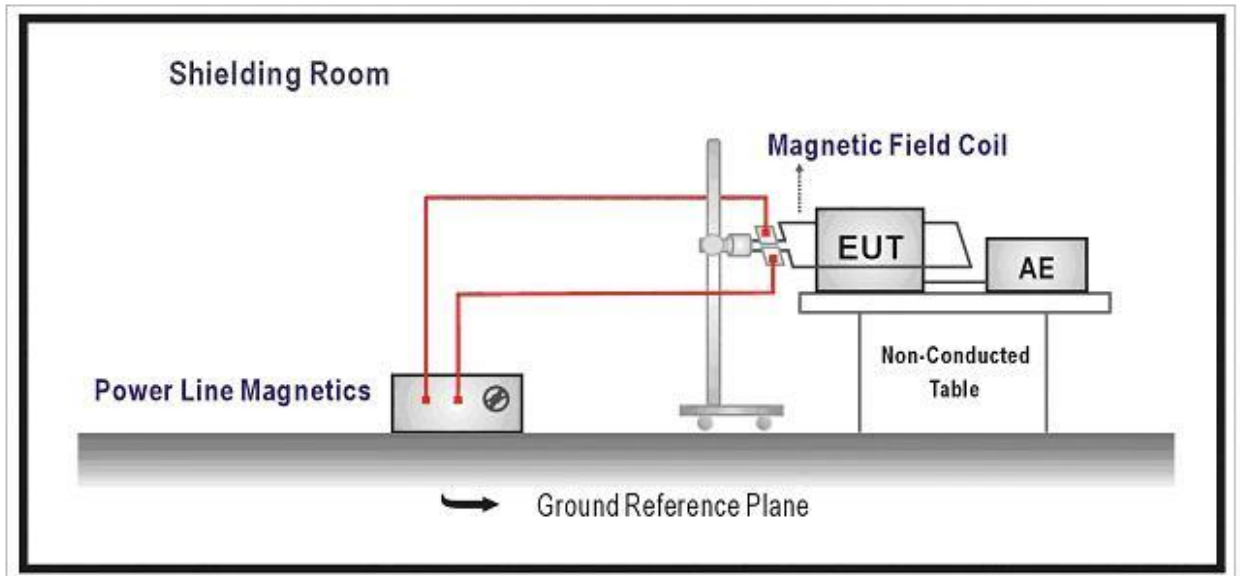

13.3. Limit

Item	Environmental Phenomena	Units	Test Specification	Performance Criteria
Enclosure Port				
	Power-Frequency Magnetic Field	Hz A/m (r.m.s.)	50 1	A

13.4. Test Procedure

The EUT and its load are placed on a table which is 0.8 meter above a metal ground plane measured at least 1m*1m min. The test magnetic field shall be placed at central of the induction coil.

The test magnetic Field shall be applied 10 minutes by the immersion method to the EUT. And the induction coil shall be rotated by 90° in order to expose the EUT to the test field with different orientation (X, Y, Z Orientations).

13.5. Deviation from Test Standard

No deviation.

13.6. Test Result

Product	Network Camera		
Test Item	Power frequency magnetic field		
Test Mode	Mode 1: AC 24V		
Date of Test	2012/09/18	Test Site	No.3 Shielded Room

Polarization	Frequency (Hz)	Magnetic Strength (A/m)	Required Performance Criteria	Performance Criteria Complied To	Test Result
X Orientation	50	1	A	A	PASS
Y Orientation	50	1	A	A	PASS
Z Orientation	50	1	A	A	PASS

- Meet criteria A: Operate as intended during and after the test
- Meet criteria B: Operate as intended after the test
- Meet criteria C: Loss/Error of function
- Additional Information
 - EUT stopped operation and could / could not be reset by operator at _____ kV of Line _____.
- No false alarms or other malfunctions were observed during or after the test. The acceptance criteria were met, and the EUT passed the test.

Product	Network Camera		
Test Item	Power frequency magnetic field		
Test Mode	Mode 2: DC 12V		
Date of Test	2012/09/18	Test Site	No.3 Shielded Room

Polarization	Frequency (Hz)	Magnetic Strength (A/m)	Required Performance Criteria	Performance Criteria Complied To	Test Result
X Orientation	50	1	A	A	PASS
Y Orientation	50	1	A	A	PASS
Z Orientation	50	1	A	A	PASS

- Meet criteria A: Operate as intended during and after the test
- Meet criteria B: Operate as intended after the test
- Meet criteria C: Loss/Error of function
- Additional Information
 - EUT stopped operation and could / could not be reset by operator at _____ kV of Line _____.
- No false alarms or other malfunctions were observed during or after the test. The acceptance criteria were met, and the EUT passed the test.

Product	Network Camera		
Test Item	Power frequency magnetic field		
Test Mode	Mode 3: PoE		
Date of Test	2012/09/18	Test Site	No.3 Shielded Room

Polarization	Frequency (Hz)	Magnetic Strength (A/m)	Required Performance Criteria	Performance Criteria Complied To	Test Result
X Orientation	50	1	A	A	PASS
Y Orientation	50	1	A	A	PASS
Z Orientation	50	1	A	A	PASS

- Meet criteria A: Operate as intended during and after the test
- Meet criteria B: Operate as intended after the test
- Meet criteria C: Loss/Error of function
- Additional Information
 - EUT stopped operation and could / could not be reset by operator at _____ kV of Line _____.
- No false alarms or other malfunctions were observed during or after the test. The acceptance criteria were met, and the EUT passed the test.

13.7. Test Photograph

Test Mode : Mode 1: AC 24V

Description : Power Frequency Magnetic Field Test Setup

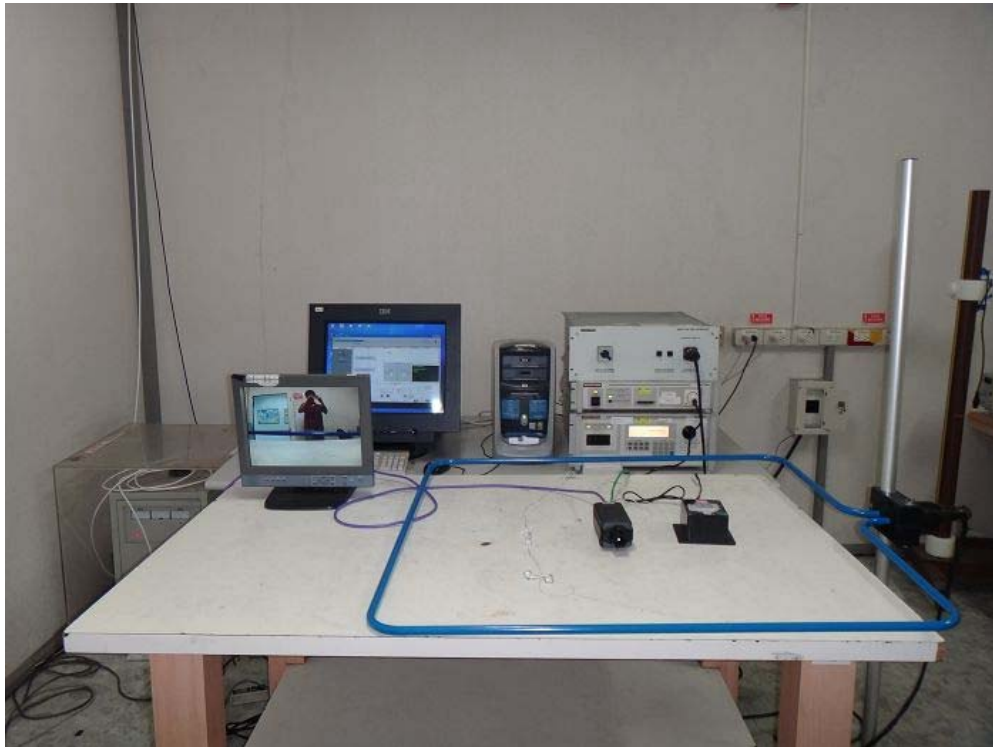

Test Mode : Mode 2: DC 12V

Description : Power Frequency Magnetic Field Test Setup



Test Mode : Mode 3: PoE

Description : Power Frequency Magnetic Field Test Setup



14. Voltage Dips and Interruption

14.1. Test Specification

According to Standard : IEC 61000-4-11

14.2. Test Setup

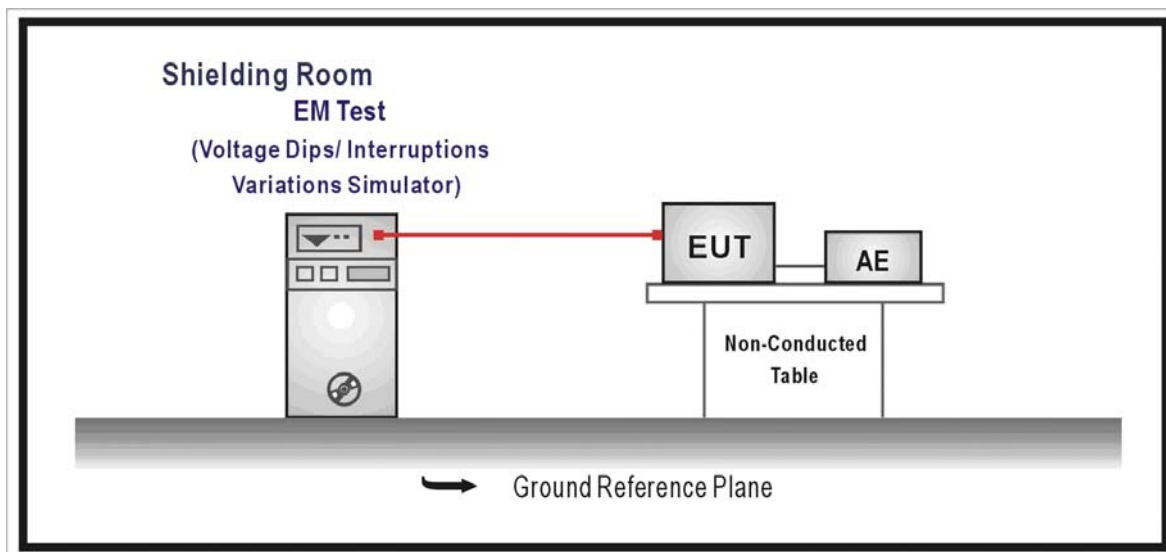

14.3. Limit

Item	Environmental Phenomena	Units	Test Specification	Performance Criteria
Input AC Power Ports				
	Voltage Dips	% Reduction	30	C
		Period	25	
	Voltage Dips	% Reduction	>95	B
		Period	0.5	
	Voltage Interruptions	% Reduction	> 95	C
		Period	250	

14.4. Test Procedure

The EUT and its load are placed on a table which is 0.8 meter above a metal ground plane measured 1m*1m min. And 0.65mm thick min. And projected beyond the EUT by at least 0.1m on all sides. The power cord shall be used the shortest power cord as specified by the manufacturer.

For Voltage Dips/ Interruptions test:

The selection of test voltage is based on the rated power range. If the operation range is large than 20% of lower power range, both end of specified voltage shall be tested.

Otherwise, the typical voltage specification is selected as test voltage.

The EUT is connected to the power mains through a coupling device that directly couples to the Voltage Dips and Interruption Generator.

The EUT shall be tested for 30% voltage dip of supplied voltage and duration 25 Periods, for 95% voltage dip of supplied voltage and duration 0.5 Periods with a sequence of three voltage dips with intervals of 10 seconds, and for 95% voltage interruption of supplied voltage and duration 250 Periods with a sequence of three voltage interruptions with intervals of 10 seconds.

Voltage phase shifting are shall occur at 0° , 45° , 90° , 135° , 180° , 225° , 270° , 315° of the voltage.

14.5. Deviation from Test Standard

No deviation.

14.6. Test Result

Product	Network Camera		
Test Item	Voltage dips and interruption		
Test Mode	Mode 1: AC 24V		
Date of Test	2012/09/18	Test Site	No.3 Shielded Room

Voltage Dips and Interruption Reduction(%)	Angle	Test Duration (Periods)	Required Performance Criteria	Performance Criteria Complied To	Test Result
30	0	25	C	A	PASS
30	45	25	C	A	PASS
30	90	25	C	A	PASS
30	135	25	C	A	PASS
30	180	25	C	A	PASS
30	225	25	C	A	PASS
30	270	25	C	A	PASS
30	315	25	C	A	PASS
>95	0	0.5	B	A	PASS
>95	45	0.5	B	A	PASS
>95	90	0.5	B	A	PASS
>95	135	0.5	B	A	PASS
>95	180	0.5	B	A	PASS
>95	225	0.5	B	A	PASS
>95	270	0.5	B	A	PASS
>95	315	0.5	B	A	PASS
>95	0	250	C	B	PASS
>95	45	250	C	B	PASS
>95	90	250	C	B	PASS
>95	135	250	C	B	PASS
>95	180	250	C	B	PASS
>95	225	250	C	B	PASS
>95	270	250	C	B	PASS
>95	315	250	C	B	PASS

- Meet criteria A: Operate as intended during and after the test
- Meet criteria B: Operate as intended after the test
- Meet criteria C: Loss/Error of function
- Additional Information
 - The nominal voltage of EUT is 230V.
 - EUT stopped operation and could / could not be reset by operator at _____ kV of Line _____.

No false alarms or other malfunctions were observed during or after the test. The acceptance criteria were met, and the EUT passed the test.

Product	Network Camera		
Test Item	Voltage dips and interruption		
Test Mode	Mode 2: DC 12V		
Date of Test	2012/09/18	Test Site	No.3 Shielded Room

Voltage Dips and Interruption Reduction(%)	Angle	Test Duration (Periods)	Required Performance Criteria	Performance Criteria Complied To	Test Result
30	0	25	C	A	PASS
30	45	25	C	A	PASS
30	90	25	C	A	PASS
30	135	25	C	A	PASS
30	180	25	C	A	PASS
30	225	25	C	A	PASS
30	270	25	C	A	PASS
30	315	25	C	A	PASS
>95	0	0.5	B	A	PASS
>95	45	0.5	B	A	PASS
>95	90	0.5	B	A	PASS
>95	135	0.5	B	A	PASS
>95	180	0.5	B	A	PASS
>95	225	0.5	B	A	PASS
>95	270	0.5	B	A	PASS
>95	315	0.5	B	A	PASS
>95	0	250	C	B	PASS
>95	45	250	C	B	PASS
>95	90	250	C	B	PASS
>95	135	250	C	B	PASS
>95	180	250	C	B	PASS
>95	225	250	C	B	PASS
>95	270	250	C	B	PASS
>95	315	250	C	B	PASS

- Meet criteria A: Operate as intended during and after the test
- Meet criteria B: Operate as intended after the test
- Meet criteria C: Loss/Error of function
- Additional Information
 - The nominal voltage of EUT is 230V.
 - EUT stopped operation and could / could not be reset by operator at _____ kV of Line _____.
- No false alarms or other malfunctions were observed during or after the test. The acceptance criteria were met, and the EUT passed the test.

14.7. Test Photograph

Test Mode : Mode 1: AC 24V

Description : Voltage Dips Test Setup



Test Mode : Mode 2: DC 12V

Description : Voltage Dips Test Setup



15. Attachment

➤ EUT Photograph

(1) EUT Photo



(2) EUT Photo



(3) EUT Photo



(4) EUT Photo



(5) EUT Photo



(6) EUT Photo

