







TEST REPORT	
EN 60950-1	
Information Technology Equipment – Safety – Part 1: General Requirements	
Test Report No.:	L120309-02-A0
Client	
Name :	VIVOTEK INC.
Address :	6F, No.192, Lien-Cheng Rd., Chung-Ho , New Taipei City, 235, Taiwan, R.O.C.
Test Item :	(1) Indoor Dome Network Camera (2) Outdoor Dome Network Camera
Identification :	(1) FD8135H (2) FD8335H
Testing laboratory	
Name :	Prodigy Technology Consultant Co., Ltd.
Address :	No.181, Sec. 2, Wunhua 1st Rd., Linkou District, New Taipei City 244, Taiwan CHINESE TAIPEI
Test specification	
Standard :	EN 60950-1:2006+A11:2009+A1:2010+A12:2011
Test Result :	The test item passed.
Prepared By :	
Signature	<u>2012-04-10</u>
<u>Candy Huang</u>	Date
Senior Engineer	
Approved By:	
Signature	<u>2012-04-10</u>
<u>Angus Hsu</u>	Date
General Manager	
Other Aspects:	 
The completed test report includes the following documents:	
<ul style="list-style-type: none"> ■ EN 60950-1 report (42 pages) ■ National Differences (19 pages) ■ Enclosures (28 pages) 	
The test report shall not be reproduced except in full, without written approval of the laboratory. This test report does not entitle to carry any safety mark on this or similar products.	



TEST REPORT	
EN 60950-1	
Information Technology Equipment – Safety – Part 1: General Requirements	
Report Reference No.	L120309-02-A0
Tested by (+ signature)	See cover sheet
Approved by (+ signature).....	See cover sheet
Date of issue.....	2012-04-10
Testing laboratory	
Name	Prodigy Technology Consultant Co., Ltd.
Address	No.181, Sec. 2, Wunhua 1st Rd., Linkou District, New Taipei City 244, Taiwan CHINESE TAIPEI
Testing location	Prodigy Technology Consultant Co., Ltd.
Address	No.181, Sec. 2, Wunhua 1st Rd., Linkou District, New Taipei City 244, Taiwan CHINESE TAIPEI
Applicant	
Name	VIVOTEK INC.
Address	6F, No.192, Lien-Cheng Rd., Chung-Ho , New Taipei City, 235, Taiwan, R.O.C.
Test specification	
Standard	EN 60950-1:2006+A11:2009+A1:2010+A12:2011
Test procedure	CE Marking serial in LVD
Procedure deviation	N/A
Non-standard test method.....	N/A
Test Report Form/blank test report	
Test Report Form No.....	IEC60950_1B
TRF originator.....	SGS Fimko Ltd
Master TRF	Dated 2010-04
Test equipment	
Description.....	(1) Indoor Dome Network Camera (2) Outdoor Dome Network Camera
Trademark	
Manufacturer	Same as applicant.
Model and/or type reference	(1) FD8135H (2) FD8335H
Rating(s).....	Optional, (1) 24Vac, 0.46A, 50-60Hz (2) 48Vdc, 0.154A (For POE)



Summary of Testing:

Unless otherwise indicated, all tests were conducted at Prodigy Technology Consultant Co., Ltd.
No.181, Sec. 2, Wunhua 1st Rd., Linkou District, New Taipei City 244, Taiwan CHINESE TAIPEI.

Tests performed (name of test and test clause)	Testing location / Comments
End Product Reference Page	
General Guidelines	
1.6.2 - Input Test: Single-Phase	
2.2.2, 2.2.3, 2.2.4, Part 22 6.1 - Selv Reliability Test Including Hazardous Voltage Measurements	
2.5 - Limited Power Source Measurements	
4.2.1 - 4.2.4 - Steady Force Tests	
4.2.5, 4.2.1, Part 22 10.2 - Impact Test	
4.2.10 - Loading Tests – Wall And Ceiling Mounted Equipment	
4.5.1, 1.4.12, 1.4.13 - Heating Test	
5.3.7 - Overload Of Operator Accessible Connector Test	

Copy of Marking Plate - Refer to Enclosure titled Marking Plate for copy.

The artwork below may be only a draft. The use of certification marks on a product must be authorized by the respective NCBs that own these marks. (Additional requirements for markings. See 1.7 NOTE)



<p>Particulars: test item vs. test requirements</p> <p>Equipment mobility : fixed</p> <p>Operating condition : Continuous</p> <p>Mains supply tolerance (%) No direct connection</p> <p>Tested for IT power systems : No</p> <p>IT testing, phase-phase voltage (V) : N/A</p> <p>Class of equipment..... : Class III</p> <p>Mass of equipment (kg)..... : 0.77 Kg (For model FD8135H) 1.26 Kg (For model FD8335H)</p> <p>Protection against ingress of water : IP66</p>
<p>Test case verdicts</p> <p>Test case does not apply to the test object..... : N/A</p> <p>Test item does meet the requirement : Pass</p> <p>Test item does not meet the requirement : Fail</p>
<p>Testing</p> <p>Date of receipt of test item.: 2012-03-05</p> <p>Date(s) of performance of test.....: 2012-03-13 to 2012-03-28</p>
<p>General remarks</p> <p>This test report shall not be reproduced except in full without the written approval of the testing laboratory. The test results presented in this report relate only to the item tested. "(see remark #)" refers to a remark appended to the report. "(see appended table)" refers to a table appended to the report. Throughout this report a point is used as the decimal separator.</p> <p>Brief description of the test equipment</p> <ul style="list-style-type: none"> - The equipment is a Class III Network Camera, The EUT is equipped with a progressive scan CMOS sensor and provides a general I/O terminal block which is used to connect external input/output devices. - The EUT installs to the ceiling. The power source can choose to use PoE or external DC(AC) power adapter. - The maximum ambient temperature specified by manufacturer is 50 °C <p>Model Differences</p> <p>Model FD8135H is identical to model FD8335H except the enclosure shape.</p> <p>Additional Information</p> <p>N/A</p> <p>Factory Location(s):</p> <p>VIVOTEK INC. 5F, No.168, Lien-Cheng Rd., Chung-Ho , New Taipei City, 235, Taiwan, R.O.C.</p> <p>Test condition</p> <p>Temperature: 25°C Relative humidity: 60% Air pressure: 950 mbar</p> <p>The test samples are pre-production without serial numbers.</p>



EN 60950-1			
------------	--	--	--

Clause	Requirement + Test	Result - Remark	Verdict
--------	--------------------	-----------------	---------

1	GENERAL		Pass
---	----------------	--	------



1.5	Components		Pass
1.5.1	General	See below.	Pass
	Comply with IEC 60950 or relevant component standard	(see appended table 1.5.1 for details.)	Pass
1.5.2	Evaluation and testing of components	<ul style="list-style-type: none"> - Components certified to IEC harmonized standard and checked for correct application. - Components, for which no relevant IEC-Standard exist, have been tested under the conditions occurring in the equipment, using applicable parts of IEC 60950-1. - Components not certified are used in accordance with their ratings and they comply with applicable parts of IEC 60950-1 and the relevant component Standard. 	Pass
1.5.3	Thermal controls		N/A
1.5.4	Transformers		N/A
1.5.5	Interconnecting cables	Interconnecting cables comply with the relevant requirements of this standard.	Pass
1.5.6	Capacitors bridging insulation	Class III equipment.	N/A
1.5.7	Resistors bridging insulation		N/A
1.5.7.1	Resistors bridging functional, basic or supplementary insulation	Class III equipment.	N/A
1.5.7.2	Resistors bridging double or reinforced insulation between a.c. mains and other circuits		N/A
1.5.7.3	Resistors bridging double or reinforced insulation between a.c. mains and antenna or coaxial cable		N/A
1.5.8	Components in equipment for IT power systems		N/A
1.5.9	Surge suppressors		N/A
1.5.9.1	General		N/A
1.5.9.2	Protection of VDRs		N/A
1.5.9.3	Bridging of functional insulation by a VDR		N/A
1.5.9.4	Bridging of basic insulation by a VDR		N/A



EN 60950-1			
Clause	Requirement + Test	Result - Remark	Verdict

1.5.9.5	Bridging of supplementary, double or reinforced insulation by a VDR		N/A
---------	---	--	-----

1.6	Power interface		Pass
1.6.1	AC power distribution systems	Class III equipment.	N/A
1.6.2	Input current	The steady state input current of the equipment did not exceed the RATED CURRENT by more than 10% under normal load See appended table 1.6.2 for details	Pass
1.6.3	Voltage limit of hand-held equipment	The unit is not a hand-held equipment.	N/A
1.6.4	Neutral conductor	Class III equipment.	N/A

1.7	Marking and instructions		Pass
1.7.1	Power rating and identification markings	Rating marking readily visible to operator. (Optional)	Pass
1.7.1.1	Power rating marking		Pass
	Multiple mains supply connections.....:		N/A
	Rated voltage(s) or voltage range(s) (V)	Optional, (1) 24Vac (2) 48Vdc (For POE)	Pass
	Symbol for nature of supply, for d.c. only	(Optional)  (60417-2-IEC-5031) for 48Vdc	Pass
	Rated frequency or frequency range (Hz)	50-60Hz for 24Vac	N/A
	Rated current (mA or A)	Optional, (1) 0.46A (2) 0.154A (For POE)	Pass
1.7.1.2	Identification markings		Pass
	Manufacturer's name or trade-mark or identification mark	Manufacturer: VIVOTEK INC or Trademark: 	Pass
	Model identification or type reference	(1) FD8135H (2) FD8335H	Pass
	Symbol for Class II equipment only	Class III equipment.	N/A
	Other markings and symbols	Additional markings are used and are defined in the installation instructions.	Pass
1.7.2	Safety instructions and marking	Operating/safety instructions made available to the user.	Pass



EN 60950-1			
Clause	Requirement + Test	Result - Remark	Verdict
1.7.2.1	General	Safety instructions in English. Other languages will be provided when submitted for national approval. - The Safety instructions may be forming by a hard copy format, website or CD-ROM.	Pass
1.7.2.2	Disconnect devices		N/A
1.7.2.3	Overcurrent protective device		N/A
1.7.2.4	IT power distribution systems		N/A
1.7.2.5	Operator access with a tool		N/A
1.7.2.6	Ozone		N/A
1.7.3	Short duty cycles	Continuous operation.	N/A
1.7.4	Supply voltage adjustment		N/A
	Methods and means of adjustment; reference to installation instructions		N/A
1.7.5	Power outlets on the equipment	No power outlets	N/A
1.7.6	Fuse identification (marking, special fusing characteristics, cross-reference)		N/A
1.7.7	Wiring terminals		N/A
1.7.7.1	Protective earthing and bonding terminals		N/A
1.7.7.2	Terminal for a.c. mains supply conductors		N/A
1.7.7.3	Terminals for d.c. mains supply conductors		N/A
1.7.8	Controls and indicators		N/A
1.7.8.1	Identification, location and marking		N/A
1.7.8.2	Colours		N/A
1.7.8.3	Symbols according to IEC 60417		N/A
1.7.8.4	Markings using figures		N/A
1.7.9	Isolation of multiple power sources		N/A
1.7.10	Thermostats and other regulating devices		N/A
1.7.11	Durability	Comply with the durability test	Pass
1.7.12	Removable parts	No marking is located on a removable parts.	Pass
1.7.13	Replaceable batteries		N/A
	Language(s)		--
1.7.14	Equipment for restricted access locations		N/A



EN 60950-1			
Clause	Requirement + Test	Result - Remark	Verdict

2	PROTECTION FROM HAZARDS		Pass
---	--------------------------------	--	------

2.1	Protection from electric shock and energy hazards		Pass
2.1.1	Protection in operator access areas		Pass
2.1.1.1	Access to energized parts	Class III equipment; no operator access to energized parts.	Pass
	Test by inspection	The operator has access only to bare parts of SELV Circuits	Pass
	Test with test finger (Figure 2A)		Pass
	Test with test pin (Figure 2B)		Pass
	Test with test probe (Figure 2C)	No TNV circuit.	N/A
2.1.1.2	Battery compartments		N/A
2.1.1.3	Access to ELV wiring	No ELV wiring in operator accessible area.	N/A
	Working voltage (V_{peak} or V_{rms}); minimum distance through insulation (mm)		—
2.1.1.4	Access to hazardous voltage circuit wiring	The operator has access only to bare parts of SELV Circuits	Pass
2.1.1.5	Energy hazards	There are no hazardous energy levels in this product.	Pass
2.1.1.6	Manual controls		N/A
2.1.1.7	Discharge of capacitors in equipment		N/A
	Measured voltage (V); time-constant (s)		—
2.1.1.8	Energy hazards – d.c. mains supply		N/A
	a) Capacitor connected to the d.c. mains supply .		N/A
	b) Internal battery connected to the d.c. mains supply		N/A
2.1.1.9	Audio amplifiers	No Audio amplifier.	N/A
2.1.2	Protection in service access areas		N/A
2.1.3	Protection in restricted access locations	No restricted access location.	N/A

2.2	SELV circuits		Pass
2.2.1	General requirements	The unit intended to be supplied by SELV.	Pass
2.2.2	Voltages under normal conditions (V)	All accessible voltage are less than 42.4Vp or 60Vdc and are classified as SELV.	Pass



EN 60950-1			
Clause	Requirement + Test	Result - Remark	Verdict

2.2.3	Voltages under fault conditions (V)..... :		Pass
2.2.4	Connection of SELV circuits to other circuits..... :	SELV circuits are only connected to other SELV circuit.	Pass

2.3	TNV circuits		N/A
2.3.1	Limits	No TNV circuit.	N/A
	Type of TNV circuits		—
2.3.2	Separation from other circuits and from accessible parts		N/A
2.3.2.1	General requirements		N/A
2.3.2.2	Protection by basic insulation		N/A
2.3.2.3	Protection by earthing		N/A
2.3.2.4	Protection by other constructions		N/A
2.3.3	Separation from hazardous voltages		N/A
	Insulation employed..... :		—
2.3.4	Connection of TNV circuits to other circuits		N/A
	Insulation employed..... :		—
2.3.5	Test for operating voltages generated externally		N/A

2.4	Limited current circuits		N/A
2.4.1	General requirements		N/A
2.4.2	Limit values		N/A
	Frequency (Hz)		—
	Measured current (mA)..... :		—
	Measured voltage (V)		—
	Measured capacitance (nF or μ F)		—
2.4.3	Connection of limited current circuits to other circuits		N/A

2.5	Limited power sources		Pass
	a) Inherently limited output	See appended table 2.5 for details.	Pass
	b) Impedance limited output	See appended table 2.5 for details.	Pass



EN 60950-1			
Clause	Requirement + Test	Result - Remark	Verdict

	c) Regulating network limited output under normal operating and single fault condition		N/A
	d) Overcurrent protective device limited output		N/A
	Max. output voltage (V), max. output current (A), max. apparent power (VA).....	See appended table 2.5 for details.	—
	Current rating of overcurrent protective device (A)		—
	Use of integrated circuit (IC) current limiters		—

2.6	Provisions for earthing and bonding		N/A
2.6.1	Protective earthing	Class III equipment.	N/A
2.6.2	Functional earthing		N/A
2.6.3	Protective earthing and protective bonding conductors		N/A
2.6.3.1	General		N/A
2.6.3.2	Size of protective earthing conductors		N/A
	Rated current (A), cross-sectional area (mm ²), AWG.....		—
2.6.3.3	Size of protective bonding conductors		N/A
	Rated current (A), cross-sectional area (mm ²), AWG.....		—
	Protective current rating (A), cross-sectional area (mm ²), AWG.....		—
2.6.3.4	Resistance of earthing conductors and their terminations; resistance (Ω), voltage drop (V), test current (A), duration (min).....		N/A
2.6.3.5	Colour of insulation.....		N/A
2.6.4	Terminals		N/A
2.6.4.1	General		N/A
2.6.4.2	Protective earthing and bonding terminals		N/A
	Rated current (A), type and nominal thread diameter (mm).....		—
2.6.4.3	Separation of the protective earthing conductor from protective bonding conductors		N/A
2.6.5	Integrity of protective earthing		—
2.6.5.1	Interconnection of equipment		N/A
2.6.5.2	Components in protective earthing conductors and protective bonding conductors		N/A



EN 60950-1			
------------	--	--	--

Clause	Requirement + Test	Result - Remark	Verdict
--------	--------------------	-----------------	---------

2.6.5.3	Disconnection of protective earth		N/A
2.6.5.4	Parts that can be removed by an operator		N/A
2.6.5.5	Parts removed during servicing		N/A
2.6.5.6	Corrosion resistance		N/A
2.6.5.7	Screws for protective bonding		N/A
2.6.5.8	Reliance on telecommunication network or cable distribution system		N/A

2.7	Overcurrent and earth fault protection in primary circuits		N/A
2.7.1	Basic requirements	Class III equipment.	N/A
	Instructions when protection relies on building installation		N/A
2.7.2	Faults not simulated in 5.3.7		N/A
2.7.3	Short-circuit backup protection		N/A
2.7.4	Number and location of protective devices		N/A
2.7.5	Protection by several devices		N/A
2.7.6	Warning to service personnel		N/A

2.8	Safety interlocks		N/A
2.8.1	General principles	No safety interlocks provided.	N/A
2.8.2	Protection requirements		N/A
2.8.3	Inadvertent reactivation		N/A
2.8.4	Fail-safe operation		N/A
	Protection against extreme hazard		N/A
2.8.5	Moving parts		N/A
2.8.6	Overriding		N/A
2.8.7	Switches and relays		N/A
2.8.7.1	Contact gaps (mm)		N/A
2.8.7.2	Overload test		N/A
2.8.7.3	Endurance test		N/A
2.8.7.4	Electric strength test (V)		N/A
2.8.8	Mechanical actuators		N/A

2.9	Electrical insulation		Pass
-----	------------------------------	--	------



EN 60950-1			
Clause	Requirement + Test	Result - Remark	Verdict

2.9.1	Properties of insulating materials	Natural rubber, materials containing asbestos and hygroscopic materials are not used.	N/A
2.9.2	Humidity conditioning	Class III equipment.	N/A
	Relative humidity (%), temperature (°C)		—
2.9.3	Grade of insulation	Functional insulation only.	Pass
2.9.4	Separation from hazardous voltages		N/A
	Method(s) used		—

2.10	Clearances, creepage distances and distances through insulation		Pass
2.10.1	General	See below.	Pass
2.10.1.1	Frequency		N/A
2.10.1.2	Pollution degrees	Pollution degree 2 applicable	Pass
2.10.1.3	Reduced values for functional insulation		N/A
2.10.1.4	Intervening unconnected conductive parts		N/A
2.10.1.5	Insulation with varying dimensions		N/A
2.10.1.6	Special separation requirements		N/A
2.10.1.7	Insulation in circuits generating starting pulses		N/A
2.10.2	Determination of working voltage	Class III equipment.	N/A
2.10.2.1	General		N/A
2.10.2.2	RMS working voltage		N/A
2.10.2.3	Peak working voltage		N/A
2.10.3	Clearances	Class III product - secondary circuits comply with Sub clause 5.3.4. Function insulation. (See appended table 2.10.3 and 2.10.4).	Pass
2.10.3.1	General		Pass
2.10.3.2	Mains transient voltages		N/A
	a) AC mains supply		N/A
	b) Earthed d.c. mains supplies		N/A
	c) Unearthed d.c. mains supplies		N/A
	d) Battery operation		N/A
2.10.3.3	Clearances in primary circuits		N/A
2.10.3.4	Clearances in secondary circuits	Functional insulation.	Pass



EN 60950-1			
Clause	Requirement + Test	Result - Remark	Verdict
2.10.3.5	Clearances in circuits having starting pulses		N/A
2.10.3.6	Transients from a.c. mains supply		N/A
2.10.3.7	Transients from d.c. mains supply		N/A
2.10.3.8	Transients from telecommunication networks and cable distribution systems		N/A
2.10.3.9	Measurement of transient voltage levels		N/A
	a) Transients from a mains supply		N/A
	For an a.c. mains supply		N/A
	For a d.c. mains supply		N/A
	b) Transients from a telecommunication network .		N/A
2.10.4	Creepage distances	Functional insulation	Pass
2.10.4.1	General		Pass
2.10.4.2	Material group and comparative tracking index		Pass
	CTI tests.....	Material group IIIb; 100 ≤ CTI <175.	—
2.10.4.3	Minimum creepage distances		N/A
2.10.5	Solid insulation		N/A
2.10.5.1	General		N/A
2.10.5.2	Distances through insulation		N/A
2.10.5.3	Insulating compound as solid insulation		N/A
2.10.5.4	Semiconductor devices		N/A
2.10.5.5.	Cemented joints		N/A
2.10.5.6	Thin sheet material – General		N/A
2.10.5.7	Separable thin sheet material		N/A
	Number of layers (pcs)		—
2.10.5.8	Non-separable thin sheet material		N/A
2.10.5.9	Thin sheet material – standard test procedure		N/A
	Electric strength test		—
2.10.5.10	Thin sheet material – alternative test procedure		N/A
	Electric strength test		—
2.10.5.11	Insulation in wound components		N/A
2.10.5.12	Wire in wound components		N/A
	Working voltage		N/A
	a) Basic insulation not under stress		N/A



EN 60950-1			
Clause	Requirement + Test	Result - Remark	Verdict
	b) Basic, supplementary, reinforced insulation		N/A
	c) Compliance with Annex U		N/A
	Two wires in contact inside wound component; angle between 45° and 90°		N/A
2.10.5.13	Wire with solvent-based enamel in wound components		N/A
	Electric strength test		—
	Routine test		N/A
2.10.5.14	Additional insulation in wound components		N/A
	Working voltage		N/A
	- Basic insulation not under stress		N/A
	- Supplementary, reinforced insulation		N/A
2.10.6	Construction of printed boards		N/A
2.10.6.1	Uncoated printed boards		N/A
2.10.6.2	Coated printed boards	No special coating is used.	N/A
2.10.6.3	Insulation between conductors on the same inner surface of a printed board		N/A
2.10.6.4	Insulation between conductors on different layers of a printed board		N/A
	Distance through insulation		N/A
	Number of insulation layers (pcs)		N/A
2.10.7	Component external terminations		N/A
2.10.8	Tests on coated printed boards and coated components		N/A
2.10.8.1	Sample preparation and preliminary inspection		N/A
2.10.8.2	Thermal conditioning		N/A
2.10.8.3	Electric strength test		N/A
2.10.8.4	Abrasion resistance test		N/A
2.10.9	Thermal cycling		N/A
2.10.10	Test for Pollution Degree 1 environment and insulating compound		N/A
2.10.11	Tests for semiconductor devices and cemented joints		N/A
2.10.12	Enclosed and sealed parts		N/A
3	WIRING, CONNECTIONS AND SUPPLY		Pass



EN 60950-1			
Clause	Requirement + Test	Result - Remark	Verdict

3.1	General		Pass
3.1.1	Current rating and overcurrent protection	All wires/conductors possess adequate cross-sectional areas for their intended application and internal wiring are adequately insulated.	Pass
3.1.2	Protection against mechanical damage	The wires are well routed away from sharp edges , etc. and are adequately fixed to prevent excessive strain on wire and terminals	Pass
3.1.3	Securing of internal wiring	The wires are positioned in such a manner that prevents excessive strain, loosening of terminal connections and damage of conductor.	Pass
3.1.4	Insulation of conductors		N/A
3.1.5	Beads and ceramic insulators		N/A
3.1.6	Screws for electrical contact pressure		N/A
3.1.7	Insulating materials in electrical connections	No contact pressure through insulating material.	Pass
3.1.8	Self-tapping and spaced thread screws		N/A
3.1.9	Termination of conductors		Pass
	10 N pull test		Pass
3.1.10	Sleeving on wiring		N/A

3.2	Connection to a mains supply		N/A
3.2.1	Means of connection	No direct connection to mains supply.	N/A
3.2.1.1	Connection to an a.c. mains supply		N/A
3.2.1.2	Connection to a d.c. mains supply		N/A
3.2.2	Multiple supply connections		N/A
3.2.3	Permanently connected equipment		N/A
	Number of conductors, diameter of cable and conduits (mm)		—
3.2.4	Appliance inlets		N/A
3.2.5	Power supply cords		N/A
3.2.5.1	AC Power supply cords		N/A



EN 60950-1			
Clause	Requirement + Test	Result - Remark	Verdict

	Type		—
	Rated current (A), cross-sectional area (mm ²), AWG		—
3.2.5.2	DC power supply cords		N/A
3.2.6	Cord anchorages and strain relief		N/A
	Mass of equipment (kg), pull (N)		—
	Longitudinal displacement (mm)		—
3.2.7	Protection against mechanical damage		N/A
3.2.8	Cord guards		N/A
	D (mm); test mass (g)		—
	Radius of curvature of cord (mm)		—
3.2.9	Supply wiring space		N/A

3.3	Wiring terminals for connection of external conductors		N/A
3.3.1	Wiring terminals	Class III equipment.	N/A
3.3.2	Connection of non-detachable power supply cords		N/A
3.3.3	Screw terminals		N/A
3.3.4	Conductor sizes to be connected		N/A
	Rated current (A), cord/cable type, cross-sectional area (mm ²)		—
3.3.5	Wiring terminals sizes		N/A
	Rated current (A), type, nominal thread diameter (mm)		—
3.3.6	Wiring terminals design		N/A
3.3.7	Grouping of wiring terminals		N/A
3.3.8	Standard wire		N/A

3.4	Disconnection from the mains supply		N/A
3.4.1	General requirement	Class III equipment.	N/A
3.4.2	Disconnect devices		N/A
3.4.3	Permanently connected equipment		N/A
3.4.4	Parts which remain energised		N/A
3.4.5	Switches in flexible cords		N/A



EN 60950-1			
Clause	Requirement + Test	Result - Remark	Verdict

3.4.6	Number of poles - single-phase and d.c. equipment		N/A
3.4.7	Number of poles - three-phase equipment		N/A
3.4.8	Switches as disconnect devices		N/A
3.4.9	Plugs as disconnect devices		N/A
3.4.10	Interconnected equipment		N/A
3.4.11	Multiple power sources		N/A

3.5	Interconnection of equipment		Pass
3.5.1	General requirements		Pass
3.5.2	Types of interconnection circuits	Interconnection circuits are SELV	Pass
3.5.3	ELV circuits as interconnection circuits	No ELV interconnections.	N/A
3.5.4	Data ports for additional equipment	Complied with LPS, See table 2.5 for details.	Pass

4	PHYSICAL REQUIREMENTS		Pass
---	------------------------------	--	------

4.1	Stability		N/A
	Angle of 10°	fixed equipment	N/A
	Test: force (N)	Not floor standing equipment.	N/A

4.2	Mechanical strength		Pass
4.2.1	General		Pass
4.2.2	Steady force test, 10 N		N/A
4.2.3	Steady force test, 30 N		N/A
4.2.4	Steady force test, 250 N		Pass
4.2.5	Impact test		Pass
	Fall test		Pass
	Swing test		N/A
4.2.6	Drop test; height (mm)		N/A
4.2.7	Stress relief		N/A
4.2.8	Cathode ray tubes		No CRT provided.
	Picture tube separately certified		N/A



EN 60950-1			
Clause	Requirement + Test	Result - Remark	Verdict

4.2.9	High pressure lamps	No high pressure lamp provided.	N/A
4.2.10	Wall or ceiling mounted equipment; force (N) ...:	Mounting means withstands three times unit weight, Force applied: 50N.	Pass
4.2.11	Rotating solid media		N/A
	Test to cover on the door.....:		N/A

4.3	Design and construction		Pass
4.3.1	Edges and corners	All edges and corners are judged to be sufficiently well rounded so as not to constitute a hazard.	Pass
4.3.2	Handles and manual controls; force (N).....:		N/A
4.3.3	Adjustable controls		N/A
4.3.4	Securing of parts		Pass
4.3.5	Connection by plugs and sockets		N/A
4.3.6	Direct plug-in equipment	Not direct plug-in equipment.	N/A
	Torque		—
	Compliance with the relevant mains plug standard		N/A
4.3.7	Heating elements in earthed equipment	No heating element.	N/A
4.3.8	Batteries		N/A
	- Overcharging of a rechargeable battery		N/A
	- Unintentional charging of a non-rechargeable battery		N/A
	- Reverse charging of a rechargeable battery		N/A
	- Excessive discharging rate for any battery		N/A
4.3.9	Oil and grease	No oil or grease.	N/A
4.3.10	Dust, powders, liquids and gases		N/A
4.3.11	Containers for liquids or gases	No liquids or gases.	N/A
4.3.12	Flammable liquids.....:	No flammable liquids.	N/A
	Quantity of liquid (l).....:		N/A
	Flash point (°C).....:		N/A
4.3.13	Radiation		Pass
4.3.13.1	General		N/A



EN 60950-1			
Clause	Requirement + Test	Result - Remark	Verdict

4.3.13.2	Ionizing radiation		N/A
	Measured radiation (pA/kg)		—
	Measured high-voltage (kV)		—
	Measured focus voltage (kV)		—
	CRT markings		—
4.3.13.3	Effect of ultraviolet (UV) radiation on materials		N/A
	Part, property, retention after test, flammability classification		N/A
4.3.13.4	Human exposure to ultraviolet (UV) radiation		N/A
4.3.13.5	Laser (including laser diodes) and LEDs	This product contains only visible indicator LEDs (Class 1)	Pass
4.3.13.5.1	Lasers (including laser laser diodes)		N/A
	Laser class		—
4.3.13.5.2	Light emitting diodes (LEDs)		—
4.3.13.6	Other types		N/A

4.4	Protection against hazardous moving parts		N/A
4.4.1	General		N/A
4.4.2	Protection in operator access areas		N/A
4.4.3	Protection in restricted access locations		N/A
4.4.4	Protection in service access areas		N/A
4.4.5	Protection against moving fan blades		N/A
4.4.5.1	General		N/A
	Not considered to cause pain or injury. a).....		N/A
	Is considered to cause pain, not injury. b)		N/A
	Considered to cause injury. c)		N/A
4.4.5.2	Protection for users		N/A
	Use of symbol or warning		N/A
4.4.5.3	Protection for service persons		N/A
	Use of symbol or warning		N/A

4.5	Thermal requirements		Pass
4.5.1	General		Pass



EN 60950-1			
Clause	Requirement + Test	Result - Remark	Verdict

4.5.2	Temperature tests	The equipment and its component parts did not attain excessive temperatures during normal operation. (see appended table 4.5)	Pass
	Normal load condition per Annex L	Operated in the most unfavorable way of operation given in the operating instructions until steady conditions established.	--
4.5.3	Temperature limits for materials	(see appended table 4.5)	Pass
4.5.4	Touch temperature limits	(see appended table 4.5)	Pass
4.5.5	Resistance to abnormal heat		N/A

4.6	Openings in enclosures		Pass
4.6.1	Top and side openings	No opening	Pass
	Dimensions (mm)		—
4.6.2	Bottoms of fire enclosures	No opening	Pass
	Construction of the bottom, dimensions (mm)		—
4.6.3	Doors or covers in fire enclosures		N/A
4.6.4	Openings in transportable equipment		N/A
4.6.4.1	Constructional design measures		N/A
	Dimensions (mm)		—
4.6.4.2	Evaluation measures for larger openings		N/A
4.6.4.3	Use of metallized parts		N/A
4.6.5	Adhesives for constructional purposes		N/A
	Conditioning temperature (°C), time (weeks).....		—

4.7	Resistance to fire		Pass
4.7.1	Reducing the risk of ignition and spread of flame	Method 1: Selection and application of components and materials which minimize the possibility of ignition and spread of flame.	Pass
	Method 1, selection and application of components wiring and materials	See appended table 1.5.1	Pass
	Method 2, application of all of simulated fault condition tests		N/A



EN 60950-1			
Clause	Requirement + Test	Result - Remark	Verdict

4.7.2	Conditions for a fire enclosure	Powered by LPS, no fire enclosure needed	Pass
4.7.2.1	Parts requiring a fire enclosure		N/A
4.7.2.2	Parts not requiring a fire enclosure		Pass
4.7.3	Materials	See table 1.5.1.	Pass
4.7.3.1	General	See below.	Pass
4.7.3.2	Materials for fire enclosures	Powered by LPS, no fire enclosure needed	N/A
4.7.3.3	Materials for components and other parts outside fire enclosures	HB or better.	Pass
4.7.3.4	Materials for components and other parts inside fire enclosures	All internal materials are rated V-2 or better or are mounted on a PWB rated V-1 or better	Pass
4.7.3.5	Materials for air filter assemblies		N/A
4.7.3.6	Materials used in high-voltage components		N/A

5	ELECTRICAL REQUIREMENTS AND SIMULATED ABNORMAL CONDITIONS		N/A
---	--	--	-----

5.1	Touch current and protective conductor current		N/A
5.1.1	General	Class III equipment	N/A
5.1.2	Configuration of equipment under test (EUT)		N/A
5.1.2.1	Single connection to an a.c. mains supply		N/A
5.1.2.2	Redundant multiple connections to an a.c. mains supply		N/A
5.1.2.3	Simultaneous multiple connections to an a.c. mains supply		N/A
5.1.3	Test circuit		N/A
5.1.4	Application of measuring instrument		N/A
5.1.5	Test procedure		N/A
5.1.6	Test measurements		N/A
	Supply voltage (V)		—
	Measured touch current (mA)		—
	Max. allowed touch current (mA)		—
	Measured protective conductor current (mA)		—



EN 60950-1			
Clause	Requirement + Test	Result - Remark	Verdict

	Max. allowed protective conductor current (mA) :		—
5.1.7	Equipment with touch current exceeding 3,5 mA		N/A
5.1.7.1	General		N/A
5.1.7.2	Simultaneous multiple connections to the supply		N/A
5.1.8	Touch currents to and from telecommunication networks and cable distribution systems and from telecommunication networks		N/A
5.1.8.1	Limitation of the touch current to a telecommunication network or to a cable distribution system		N/A
	Supply voltage (V)		—
	Measured touch current (mA)		—
	Max. allowed touch current (mA)		—
5.1.8.2	Summation of touch currents from telecommunication networks		N/A
	a) EUT with earthed telecommunication ports		N/A
	b) EUT whose telecommunication ports have no reference to protective earth		N/A

5.2	Electric strength		N/A
5.2.1	General	Class III equipment	N/A
5.2.2	Test procedure		N/A

5.3	Abnormal operating and fault conditions		N/A
5.3.1	Protection against overload and abnormal operation		N/A
5.3.2	Motors		N/A
5.3.3	Transformers		N/A
5.3.4	Functional insulation		N/A
5.3.5	Electromechanical components		N/A
5.3.6	Audio amplifiers in ITE		N/A
5.3.7	Simulation of faults		N/A
5.3.8	Unattended equipment		N/A
5.3.9	Compliance criteria for abnormal operating and fault conditions		N/A
5.3.9.1	During the tests		N/A



EN 60950-1			
Clause	Requirement + Test	Result - Remark	Verdict

5.3.9.2	After the tests		N/A
---------	-----------------	--	-----

6	CONNECTION TO TELECOMMUNICATION NETWORKS		N/A
----------	---	--	-----

6.1	Protection of telecommunication network service personnel, and users of other equipment connected to the network, from hazards in the equipment		N/A
6.1.1	Protection from hazardous voltages		N/A
6.1.2	Separation of the telecommunication network from earth		N/A
6.1.2.1	Requirements		N/A
	Supply voltage (V)		—
	Current in the test circuit (mA)		—
6.1.2.2	Exclusions		N/A

6.2	Protection of equipment users from overvoltages on telecommunication networks		N/A
6.2.1	Separation requirements		N/A
6.2.2	Electric strength test procedure		N/A
6.2.2.1	Impulse test		N/A
6.2.2.2	Steady-state test		N/A
6.2.2.3	Compliance criteria		N/A

6.3	Protection of telecommunication wiring system from overheating		N/A
	Max. output current (A)		—
	Current limiting method		—

7	CONNECTION TO CABLE DISTRIBUTION SYSTEMS		N/A
----------	---	--	-----

7.1	General		N/A
7.2	Protection of cable distribution system service persons, and users of other equipment connected to the system, from hazardous voltages in the equipment		N/A



EN 60950-1			
Clause	Requirement + Test	Result - Remark	Verdict
7.3	Protection of equipment users from overvoltages on the cable distribution system		N/A
7.4	Insulation between primary circuits and cable distribution systems		N/A
7.4.1	General		N/A
7.4.2	Voltage surge test		N/A
7.4.3	Impulse test		N/A



EN 60950-1			
Clause	Requirement + Test	Result - Remark	Verdict

A	ANNEX A, TESTS FOR RESISTANCE TO HEAT AND FIRE		N/A
A.1	Flammability test for fire enclosures of movable equipment having a total mass exceeding 18 kg, and of stationary equipment (see 4.7.3.2)		N/A
A.1.1	Samples		N/A
	Wall thickness (mm).....:		—
A.1.2	Conditioning of samples; temperature (°C)		N/A
A.1.3	Mounting of samples.....:		N/A
A.1.4	Test flame (see IEC 60695-11-3)		N/A
	Flame A, B, C or D		—
A.1.5	Test procedure		N/A
A.1.6	Compliance criteria		N/A
	Sample 1 burning time (s).....:		—
	Sample 2 burning time (s).....:		—
	Sample 3 burning time (s).....:		—
A.2	Flammability test for fire enclosures of movable equipment having a total mass not exceeding 18 kg, and for material and components located inside fire enclosures (see 4.7.3.2 and 4.7.3.4)		N/A
A.2.1	Samples		N/A
	Wall thickness (mm).....:		—
A.2.2	Conditioning of samples; temperature (°C)		N/A
A.2.3	Mounting of samples.....:		N/A
A.2.4	Test flame (see IEC 60695-11-4)		N/A
	Flame A, B or C		—
A.2.5	Test procedure		N/A
A.2.6	Compliance criteria		N/A
	Sample 1 burning time (s).....:		—
	Sample 2 burning time (s).....:		—
	Sample 3 burning time (s).....:		—
A.2.7	Alternative test acc. to IEC 60695-11-5, cl. 5 and 9		N/A
	Sample 1 burning time (s).....:		—
	Sample 2 burning time (s).....:		—
	Sample 3 burning time (s).....:		—
A.3	Hot flaming oil test (see 4.6.2)		N/A
A.3.1	Mounting of samples		N/A



EN 60950-1			
Clause	Requirement + Test	Result - Remark	Verdict

A.3.2	Test procedure		N/A
A.3.3	Compliance criterion		N/A

B	ANNEX B, MOTOR TESTS UNDER ABNORMAL CONDITIONS (see 4.7.2.2 and 5.3.2)		N/A
B.1	General requirements		N/A
	Position		—
	Manufacturer		—
	Type		—
	Rated values		—
B.2	Test conditions		N/A
B.3	Maximum temperatures		N/A
B.4	Running overload test		N/A
B.5	Locked-rotor overload test		N/A
	Test duration (days)		—
	Electric strength test: test voltage (V)		—
B.6	Running overload test for DC motors in secondary circuits		N/A
B.6.1	General		N/A
B.6.2	Test procedure		N/A
B.6.3	Alternative test procedure		N/A
B.6.4	Electric strength test; test voltage (V)		N/A
B.7	Locked-rotor overload test for DC motors in secondary circuits		N/A
B.7.1	General		N/A
B.7.2	Test procedure		N/A
B.7.3	Alternative test procedure		N/A
B.7.4	Electric strength test; test voltage (V)		N/A
B.8	Test for motors with capacitors		N/A
B.9	Test for three-phase motors		N/A
B.10	Test for series motors		N/A
	Operating voltage (V)		—

C	ANNEX C, TRANSFORMERS (see 1.5.4 and 5.3.3)		N/A
	Position		—



EN 60950-1			
Clause	Requirement + Test	Result - Remark	Verdict

	Manufacturer		—
	Type		—
	Rated values		
	Method of protection		—
C.1	Overload test		N/A
C.2	Insulation		N/A
	Protection from displacement of windings		—

D	ANNEX D, MEASURING INSTRUMENTS FOR TOUCH-CURRENT TESTS (see 5.1.4)		N/A
D.1	Measuring instrument		N/A
D.2	Alternative measuring instrument		N/A

E	ANNEX E, TEMPERATURE RISE OF A WINDING (see 1.4.13)		N/A
---	--	--	-----

F	ANNEX F, MEASUREMENT OF CLEARANCES AND CREEPAGE DISTANCES (see 2.10 and Annex G)		Pass
---	---	--	------

G	ANNEX G, ALTERNATIVE METHOD FOR DETERMINING MINIMUM CLEARANCES		N/A
G.1	Clearances		N/A
G.1.1	General		N/A
G.1.2	Summary of the procedure for determining minimum clearances		N/A
G.2	Determination of mains transient voltage (V)		N/A
G.2.1	AC mains supply		N/A
G.2.2	Earthed d.c. mains supplies		N/A
G.2.3	Unearthed d.c. mains supplies		N/A
G.2.4	Battery operation		N/A
G.3	Determination of telecommunication network transient voltage (V)		N/A
G.4	Determination of required withstand voltage (V)		N/A
G.4.1	Mains transients and internal repetitive peaks		N/A
G.4.2	Transients from telecommunication networks		N/A
G.4.3	Combination of transients		N/A



EN 60950-1			
Clause	Requirement + Test	Result - Remark	Verdict

G.4.4	Transients from cable distribution systems		N/A
G.5	Measurement of transient voltages (V)		N/A
	a) Transients from a mains supply		N/A
	For an a.c. mains supply		N/A
	For a d.c. mains supply		N/A
	b) Transients from a telecommunication network		N/A
G.6	Determination of minimum clearances		N/A

H	ANNEX H, IONIZING RADIATION (see 4.3.13)		N/A
---	---	--	-----

J	ANNEX J, TABLE OF ELECTROCHEMICAL POTENTIALS (see 2.6.5.6)		N/A
	Metal(s) used		—

K	ANNEX K, THERMAL CONTROLS (see 1.5.3 and 5.3.8)		N/A
K.1	Making and breaking capacity	No thermal control.	N/A
K.2	Thermostat reliability; operating voltage (V)		N/A
K.3	Thermostat endurance test; operating voltage(V):		N/A
K.4	Temperature limiter endurance; operating voltage (V)		N/A
K.5	Thermal cut-out reliability		N/A
K.6	Stability of operation		N/A

L	ANNEX L, NORMAL LOAD CONDITIONS FOR SOME TYPES OF ELECTRICAL BUSINESS EQUIPMENT (see 1.2.2.1 and 4.5.2)		Pass
L.1	Typewriters		N/A
L.2	Adding machines and cash registers		N/A
L.3	Erasers		N/A
L.4	Pencil sharpeners		N/A
L.5	Duplicators and copy machines		N/A
L.6	Motor-operated files		N/A
L.7	Other business equipment		Pass

M	ANNEX M, CRITERIA FOR TELEPHONE RINGING SIGNALS (see 2.3.1)		N/A
M.1	Introduction		N/A



EN 60950-1			
Clause	Requirement + Test	Result - Remark	Verdict

M.2	Method A		N/A
M.3	Method B		N/A
M.3.1	Ringling signal		N/A
M.3.1.1	Frequency (Hz)		N/A
M.3.1.2	Voltage (V)		N/A
M.3.1.3	Cadence; time (s), voltage (V)		N/A
M.3.1.4	Single fault current (mA)		N/A
M.3.2	Tripping device and monitoring voltage.....		N/A
M.3.2.1	Conditions for use of a tripping device or a monitoring voltage		N/A
M.3.2.2	Tripping device		N/A
M.3.2.3	Monitoring voltage (V).....		N/A

N	ANNEX N, IMPULSE TEST GENERATORS (see 1.5.7.2, 1.5.7.3, 2.10.3.9, 6.2.2.1, 7.3.2, 7.4.3 and Clause G.5)		N/A
N.1	ITU-T impulse test generators		N/A
N.2	IEC 60065 impulse test generator		N/A

P	ANNEX P, NORMATIVE REFERENCES		Pass
---	--------------------------------------	--	------

Q	ANNEX Q, Voltage dependent resistors (VDRs) (see 1.5.9.1)		N/A
	a) Preferred climatic categories		N/A
	b) Maximum continuous voltage		N/A
	c) Pulse current		N/A

R	ANNEX R, EXAMPLES OF REQUIREMENTS FOR QUALITY CONTROL PROGRAMMES		N/A
R.1	Minimum separation distances for unpopulated coated printed boards (see 2.10.6.2)		N/A
R.2	Reduced clearances (see 2.10.3)		N/A

S	ANNEX S, PROCEDURE FOR IMPULSE TESTING (see 6.2.2.3)		N/A
S.1	Test equipment		N/A
S.2	Test procedure		N/A
S.3	Examples of waveforms during impulse testing		N/A



EN 60950-1			
Clause	Requirement + Test	Result - Remark	Verdict

T	ANNEX T, GUIDANCE ON PROTECTION AGAINST INGRESS OF WATER (see 1.1.2)		N/A
	Separate test report		—

U	ANNEX U, INSULATED WINDING WIRES FOR USE WITHOUT INTERLEAVED INSULATION (see 2.10.5.4)		N/A
	Separate test report		N/A

V	ANNEX V, AC POWER DISTRIBUTION SYSTEMS (see 1.6.1)		N/A
V.1	Introduction		N/A
V.2	TN power systems		N/A

W	ANNEX W, SUMMATION OF TOUCH CURRENTS		N/A
W.1	Touch current from electronic circuits		N/A
W.1.1	Floating circuits		N/A
W.1.2	Earthed circuits		N/A
W.2	Interconnection of several equipments		N/A
W.2.1	Isolation		N/A
W.2.2	Common return, isolated from earth		N/A
W.2.3	Common return, connected to protective earth		N/A
X	ANNEX X, MAXIMUM HEATING EFFECT IN TRANSFORMER TESTS (see clause C.1)		N/A
X.1	Determination of maximum input current		N/A
X.2	Overload test procedure		N/A

Y	ANNEX Y, ULTRAVIOLET LIGHT CONDITIONING TEST (see 4.3.13.3)		N/A
Y.1	Test apparatus		N/A
Y.2	Mounting of test samples		N/A
Y.3	Carbon-arc light-exposure apparatus		N/A
Y.4	Xenon-arc light exposure apparatus		N/A

Z	ANNEX Z, OVERVOLTAGE CATEGORIES (see 2.10.3.2 and Clause G.2)		N/A
---	--	--	-----

AA	ANNEX AA, MANDREL TEST (see 2.10.5.8)		N/A
----	--	--	-----



EN 60950-1			
Clause	Requirement + Test	Result - Remark	Verdict

BB	ANNEX BB, CHANGES IN THE SECOND EDITION		N/A
----	--	--	-----

CC	ANNEX CC, Evaluation of integrated circuit (IC) current limiters		N/A
CC.1	General		N/A
CC.2	Test program 1.....:		N/A
CC.3	Test program 2.....:		N/A

DD	ANNEX DD, Requirements for the mounting means of rack-mounted equipment		N/A
DD.1	General		N/A
DD.2	Mechanical strength test, variable N.....:		N/A
DD.3	Mechanical strength test, 250N, including end stops.....:		N/A
DD.4	Compliance.....:		N/A

EE	ANNEX EE, Household and home/office document/media shredders		N/A
EE.1	General		N/A
EE.2	Markings and instructions		N/A
	Use of markings or symbols.....:		N/A
	Information of user instructions, maintenance and/or servicing instructions.....:		N/A
EE.3	Inadvertent reactivation test.....:		N/A
EE.4	Disconnection of power to hazardous moving parts:		N/A
	Use of markings or symbols.....:		N/A
EE.5	Protection against hazardous moving parts		N/A
	Test with test finger (Figure 2A)		N/A
	Test with wedge probe (Figure EE1 and EE2)		N/A



IEC 60950-1			
Clause	Requirement - Test	Result - Remark	Verdict

1.5.1	TABLE: List of critical components					Pass
object/part No.	manufacturer/ trademark	type/model	technical data	standard	mark(s) of conformity ¹⁾	
Power from AC source (optional)	Various	Various	O/P: 24Vac, 50-60Hz, 0.46A Minimum, Marked with "LPS" or "Limited Power Source" or complied with "Limited Power Source" checked by inspection	IEC 60950-1 EN 60950-1	TUV, CE	
Metal Enclosure for Models FD8335H, FD8135H	--	--	Al, 2.0 mm thickness minimum, overall see Diagrams for detail.	--	--	
Plastic Enclosure for Model FD8135H	--	--	Rated HB min, 2.5 mm thickness minimum, overall see Diagrams for detail.	UL 94, UL746C	UL	
Lens cover	TEIJIN CHEMICALS LTD	L-1225#(f2)	HB , 2.5mm min., outdoor used.	UL 94, UL746C	UL	
PWB	--	--	V-1 or better, 105 °C	UL 796	UL	
Transformer of PoE Board (T1)	Coilcraft, Inc.	POE13F-12L	105 °C. See Enclosure 4-01	--	--	
Alternate of transformer of PoE Board (T1)	Acroparts Technology Co., Ltd.	POE13F-12L (13W12V)	105 °C. See Enclosure 4-02	--	--	
O-ring for Models FD8335H	MING YEE INDUSTRIAL CO., LTD.	612013200G	EPDM rubber, overall see Diagrams for detail.	--	--	
Liquid-tight flexible cord connectors (for General I/O Terminal)(optional)	AVC Industrial Corp.	MG16A-2H2.8C-6H2.0B-ST-SPM-XA	V-2 min., 80 °C	--	--	
Liquid-tight plug (for General I/O Terminal)(optional)	AVC Industrial Corp.	SPG-M16-G	V-2 min., 80 °C	--	--	
Liquid-tight plug (for network wire)(optional)	AVC Industrial Corp.	GEW16-08-05SG	-40~130 °C	--	--	



IEC60950_1B - ATTACHMENT			
Clause	Requirement + Test	Result - Remark	Verdict

1.5.1	TABLE: List of critical components					Pass
object/part No.	manufacturer/ trademark	type/model	technical data	standard	mark(s) of conformity ¹⁾	
Supplementary information:--						

1.5.1	TABLE: Opto Electronic Devices					N/A
Manufacturer						
Type						
Separately tested.....						
Bridging insulation						
External creepage distance.....						
Internal creepage distance						
Distance through insulation						
Tested under the following conditions						
Input.....						
Output.....						
supplementary information						



IEC 60950-1			
Clause	Requirement - Test	Result - Remark	Verdict

1.6.2	TABLE: Electrical data (in normal conditions)						Pass
U(V)/f(Hz)	I (A)	I _{rated} (A)	P (W)	Fuse #	I _{fuse} (A)	Condition/status	
--	--	--	--	--	--	For model: FD8335H	
48Vdc (POE)	0.10	0.154	4.80	--	--	Maximum Normal Load	
24Vac/50 Hz	0.30	0.46	4.80	--	--	Maximum Normal Load	
24Vac/60 Hz	0.30	0.46	4.80	--	--	Maximum Normal Load	
--	--	--	--	--	--	For model: FD8135H	
48Vdc (POE)	0.12	0.154	5.76	--	--	Maximum Normal Load	
24Vac/50 Hz	0.29	0.46	4.7	--	--	Maximum Normal Load	
24Vac/60 Hz	0.29	0.46	4.7	--	--	Maximum Normal Load	

Note: Maximum Normal Load: Unit transfer video signal from RJ-45 connected to the computer and working continuously.

2.2.2	Table Hazardous Voltage (Circuit) Measurement			Pass
Clearance (cl) and creepage distance (cr) at/of/between:	U _p (V)	U r.m.s. (V)	Limiting component	
T1 Pin 1,2 –GND	--	49.6	--	
T1 Pin 3 –GND	--	0	--	
T1 Pin 5,6 –GND	0.9	--	--	
T1 Pin 7,8 –GND	17.8	--	--	
T1 Pin 10 –GND	22.8	--	--	
T1 Pin 11,12 –GND	108	--	T1 Pin 11,12 –GND	
C334 Pin 1 – 2	0.9	--	--	
U40 Pin 3 – 1	1.1	--	--	
U40 Pin 3 – 2	1.1	--	--	
U40 Pin 4 – 1	1.02	--	--	
U40 Pin 4 – 2	1.06	--	--	
L76 Pin 1 – GND	--	48.8	--	
D34 Pin 2 – GND	--	96.0	D34	
D35 Pin 2 – GND	--	12.8	--	
Q13 Pin 1,2,3 - GND	0.4	--	--	
Q13 Pin 4 - GND	11.8	--	--	
Fault test performed on voltage limiting components	Voltage measured (V) in SELV circuits (V peak or V d.c.)			
T1 Pin11,12-GND Short	7.2Vdc			
C4 Short	2.4Vdc			
Note(s): GND:T1 Pin3				



IEC60950_1B - ATTACHMENT

Clause	Requirement + Test	Result - Remark	Verdict
--------	--------------------	-----------------	---------

2.2.3	TABLE: SELV Reliability Test							N/A
No. Accessible Part From – To	Component No. (Voltage Limiting)	Fault	Test Voltage	Test time (Duration)	Fuse No.	Fuse Current (A)	Result Specify Maximum Vpk or V dc	
--	--	--	--	--	--	--	--	

Note(s):--

2.5	TABLE: limited power source measurements						Pass
output tested	measured		single fault condition	measured value (maximum)			
	from	to		Uoc	Isc	VA	
For model FD8135H							
For 48Vdc							
Impedance limited							
Micro SD Card Pin 4 - GND	V+	V-	--	3.32	1.55	2.54	
General I/O terminal Pin 8 – GND	V+	V-	--	11.75	1.80	8.83	
Micro SD Card Pin 1,2,7,8	V+	V-	--	2.78	0.01	0.01	
Micro SD Card Pin 3	V+	V-	--	3.32	0.03	0.01	
Micro SD Card Pin 9	V+	V-	--	3.00	0.01	0.01	
General I/O terminal Pin 3,4,5	V+	V-	--	6.40	0.01	0.01	
Inherently limited							
Micro SD Card Pin5,6,10-13	V+	V-	--	0	--	--	
general I/O terminal Pin 1,2,6,7,	V+	V-	--	0	--	--	
AV out All pin	V+	V-	--	0	--	--	
Audio in All pin	V+	V-	--	0	--	--	
For 24Vac							
Impedance limited							
Micro SD Card Pin 4 - GND	V+	V-	--	3.32	1.55	2.54	
General I/O terminal Pin	V+	V-	--	11.75	1.80	8.83	



IEC60950_1B - ATTACHMENT

Clause	Requirement + Test			Result - Remark		Verdict
8 – GND						
Micro SD Card Pin 1,2,7,8	V+	V-	--	2.78	0.01	0.01
Micro SD Card Pin 3	V+	V-	--	3.32	0.03	0.01
Micro SD Card Pin 9	V+	V-	--	3.00	0.01	0.01
General I/O terminal Pin 3,4,5	V+	V-	--	6.40	0.01	0.01
Inherently limited						
Micro SD Card Pin5,6,10-13	V+	V-	--	0	--	--
general I/O terminal Pin 1,2,6,7,	V+	V-	--	0	--	--
AV out All pin	V+	V-	--	0	--	--
Audio in All pin	V+	V-	--	0	--	--
Ethernet All pins	V+	V-	--	0	--	--
Note : --						

2.10.3 and 2.10.4	TABLE: Clearance and creepage distance measurements						N/A
Clearance (cl) and creepage distance (cr) at/of/between:	U peak (V)	U r.m.s. (V)	Required cl (mm)	cl (mm)	Required cr (mm)	cr (mm)	
Functional:							
--	--	--	--	--	--	--	
Basic/supplementary:							
--	--	--	--	--	--	--	
Reinforced:							
--	--	--	--	--	--	--	
Supplementary information: -- All circuits are SELV, only functional insulation required.							

4.3.8	TABLE: Batteries		N/A
The tests of 4.3.8 are applicable only when appropriate battery data is not available.	--		--
Is it possible to install the battery in a reverse polarity position	--		--
	Non-rechargeable batteries	Rechargeable batteries	



IEC60950_1B - ATTACHMENT

Clause	Requirement + Test	Result - Remark	Verdict
--------	--------------------	-----------------	---------

	Discharging		Un-intentional charging	Charging		Discharging		Reversed charging	
	Meas. current	Manuf. specs.		Meas. current	Manuf. specs.	Meas. current	Manuf. specs.	Meas. current	Manuf. specs.
Max. current during normal condition	--	--	--	--	--	--	--	--	--
Max. A during fault condition	--	--	--	--	--	--	--	--	--
--									
Test results:						--			Verdict
- Chemical leaks						--			N/A
- Explosion of the battery						--			N/A
- Emission of flame or expulsion of molten metal						--			N/A
- Electric strength tests of equipment after completion of tests						--			N/A
supplementary information:-- See Enclosure/Miscellaneous 7-01, appended table 4.3.8 for details.									

4.5	TABLE: Temperature rise measurements				Pass	
	test voltage (V)	See below			---	
	t _{amb1} (°C)	--			---	
	t _{amb2} (°C)	--			---	
maximum temperature T of part/at::		T (°C)			allowed T _{max} (°C)	
For model FD8135H		Maximum Normal Load at 48Vdc (H)	Maximum Normal Load at 48Vdc (H) (Shift to T _{ma} 50°C)	Maximum Normal Load at 48Vdc (V)	Maximum Normal Load at 48Vdc (V) (Shift to T _{ma} 50°C)	--
--		Ceiling	Ceiling	Wall	Wall	--
01. Ambient		21.1	50.0	20.8	50.0	--
For main board		--	--	--	--	--
02.AC terminal		44.4	73.3	44.4	73.6	95
03.L25 coil		47.4	76.3	44.6	73.8	105



IEC60950_1B - ATTACHMENT

Clause	Requirement + Test	Result - Remark			Verdict
04.C16 body	44.1	73.0	43.1	72.3	85
05.T1 core	50.6	79.5	48.6	77.8	105
06.T1 coil	55.9	84.8	53.2	82.4	105
07.L16 coil	46.0	74.9	44.4	73.6	105
08.PWB under U1	41.4	70.3	39.7	68.9	105
For I/O board	--	--	--	--	--
09.BT1 body	40.3	69.2	38.5	67.7	85
10.PWB under U28	40.7	69.6	38.7	67.9	105
11.Metal enclosure	36.2	65.1	35.7	64.9	70
12.Plastic enclosure inside near top	31.5	60.4	35.0	64.2	65
13.Plastic enclosure outside near top	28.4	57.3	31.1	60.3	95
Test duration :	2.1 hrs	2.1 hrs	1.5 hrs	1.5 hrs	--
--	Maximum Normal Load at 24 Vac, 60 Hz	Maximum Normal Load at 24 Vac, 60 Hz (Shift to Tma 50°C)	--	--	--
--	Ceiling	Ceiling	--	--	--
For FD8135H	--	--	--	--	--
01. Ambient	21.0	50.0	--	--	--
For main board	--	--	--	--	--
02.AC terminal	45.3	74.3	--	--	95
03.L25 coil	48.0	77.0	--	--	105
04.C16 body	46.4	75.4	--	--	85
05.T1 core	51.0	80.0	--	--	105
06.T1 coil	56.1	85.1	--	--	105
07.L16 coil	46.9	75.9	--	--	105
08.PWB under U1	42.2	71.2	--	--	105
For I/O board	--	--	--	--	--
09.BT1 body	41.1	70.1	--	--	85
10.PWB under U28	41.5	70.5	--	--	105
11.Metal enclosure	36.5	65.5	--	--	70
12.Plastic enclosure inside near top	33.2	62.2	--	--	65
13.Plastic enclosure outside near top	30.3	59.3	--	--	95
Test duration :	2.8hrs	2.8hrs	--	--	--



IEC60950_1B - ATTACHMENT

Clause	Requirement + Test	Result - Remark	Verdict
--------	--------------------	-----------------	---------

For model FD8335H	Maximum Normal Load at 48Vdc (H)	Maximum Normal Load at 48Vdc (H) (Shift to Tma 50°C)	Maximum Normal Load at 48Vdc (V)	Maximum Normal Load at 48Vdc (V) (Shift to Tma 50°C)	--
--	Ceiling	Ceiling	Wall	Wall	--
01. Ambient	21.0	50.0	21.7	50.0	--
For main board	--	--	--	--	--
02.AC terminal	39.5	68.5	38.9	67.2	95
03.L25 coil	46.7	75.7	47.3	75.6	105
04.C16 body	39.5	68.5	38.9	67.2	85
05.T1 core	47.4	76.4	47.5	75.8	105
06.T1 coil	47.7	76.7	47.6	75.9	105
07.L16 coil	38.6	67.6	38.3	66.6	105
08.PWB under U1	34.0	63.0	34.3	62.6	105
For I/O board	--	--	--	--	--
09.BT1 body	34.7	63.7	34.9	63.2	85
10.PWB under U28	35.8	64.8	36.2	64.5	105
11.Metal enclosure	32.0	61.0	32.7	61.0	70
12.Plastic enclosure inside near top	27.5	56.5	28.7	57.0	65
13.Plastic enclosure outside near top	26.0	55.0	27.1	55.4	95
Test duration :	2.8 hrs	2.8 hrs	2.0 hrs	2.0 hrs	--
For model FD8335H	Maximum Normal Load at 24 Vac, 60 Hz	Maximum Normal Load at 24 Vac, 60 Hz (Shift to Tma 50°C)	--	--	--
--	Ceiling	Ceiling	--	--	--
01. Ambient	23.3	50.0	--	--	--
For main board	--	--	--	--	--
02.AC terminal	41.5	68.2	--	--	95
03.L25 coil	48.3	75.0	--	--	105
04.C16 body	41.9	68.6	--	--	85
05.T1 core	48.9	75.6	--	--	105
06.T1 coil	49.0	75.7	--	--	105
07.L16 coil	40.4	67.1	--	--	105
08.PWB under U1	35.6	62.3	--	--	105



IEC60950_1B - ATTACHMENT

Clause	Requirement + Test	Result - Remark		Verdict
--------	--------------------	-----------------	--	---------

For I/O board	--	--	--	--	--
09.BT1 body	36.4	63.1	--	--	85
10.PWB under U28	37.6	64.3	--	--	105
11.Metal enclosure	33.9	60.6	--	--	70
12.Plastic enclosure inside near top	29.2	55.9	--	--	65
13.Plastic enclosure outside near top	27.7	54.4	--	--	95
Test duration :	3.0 hrs	3.0 hrs	--	--	--

Supplementary information:

- The temperatures were measured under worst case normal mode defined in 1.2.2.1 and as described in sub-clause 1.6.2 and at voltages as described above.
- With a maximum ambient temperature of 50°C.
- All values for T (°C) are re-calculated from actual ambient which the actual ambient lower than manufacturer's specification ambient temperature.
- All values for T (°C) are without re-calculated from actual ambient which the actual ambient higher than manufacturer's specification ambient temperature.

Winding components (providing safety isolation):

Other component:

- Max. temp. of 85°C (Capacitor)
- Max. temp. of 105°C (PCB)
- when no class of insulation is given, min. insulation 105°C assumed.

User accessible area:

- material is metal: 70°C
- material is plastic: 95°C

4.6	TABLE: enclosure opening		N/A
Location	Size (mm)	Comments	
--	--	--	
Note(s): --			

5.1	TABLE: Touch current measurement			N/A
Measured between:	Measured (mA)	Limit (mA)	Comments/conditions	
--	--	--	--	
supplementary information: --				



IEC60950_1B - ATTACHMENT

Clause	Requirement + Test	Result - Remark	Verdict
--------	--------------------	-----------------	---------

5.2	TABLE: electric strength tests, impulse tests and voltage surge tests			N/A
Test voltage applied between:		Voltage shape (AC, DC, impulse, surge)	Test voltage (V)	Breakdown Yes / No
Basic/supplementary:				
--		--	--	--
Reinforced:				
--		--	--	--
--				

5.3	TABLE: Fault condition tests						Pass
ambient temperature (°C)				--			---
model/type of power supply				--			---
manufacturer of power supply				--			---
rated markings of power supply				--			---
component No.	fault	test voltage (V)	test time	fuse No.	fuse current (A)	result	
--	--	--	--	--	--	5.3.7 Overload of operator accessible connector test	
--	--	--	--	--	--	For model FD8135H	
Micro SD Card Pin4	Overload	48Vdc	--	--	--	Open Voltage: 3.32V, Maximum Current: 900mA NC, NT	
General I/O terminal Pin8	Overload	48Vdc	--	--	--	Open Voltage: 11.75V, Maximum Current: 1350mA NC, NT	
Micro SD Card Pin1,2,7,8	Overload	48Vdc	--	--	--	Open Voltage: 2.78V, Maximum Current: 10mA NC, NT	
Micro SD Card Pin3	Overload	48Vdc	--	--	--	Open Voltage: 3.32V, Maximum Current: 20mA NC, NT	
Micro SD Card Pin9	Overload	48Vdc	--	--	--	Open Voltage: 3.00V, Maximum Current: 10mA NC, NT	
General I/O terminal Pin3,4,5	Overload	48Vdc	--	--	--	Open Voltage: 6.40V, Maximum Current: 10mA NC, NT	
Micro SD Card Pin5,6,10-13	Overload	48Vdc	--	--	--	Open Voltage: 0V, B	
General I/O terminal Pin1,2,6,7	Overload	48Vdc	--	--	--	Open Voltage: 0V, B	
AV out All Pin	Overload	48Vdc	--	--	--	Open Voltage: 0V, B	



IEC60950_1B - ATTACHMENT

Clause	Requirement + Test				Result - Remark	Verdict
Audio in All Pin	Overload	48Vdc	--	--	--	Open Voltage: 0V, B
--	--	--	--	--	--	For model FD8135H
Micro SD Card Pin4	Overload	24Vac	--	--	--	Open Voltage: 3.32V, Maximum Current: 900mA NC, NT
General I/O terminal Pin8	Overload	24Vac	--	--	--	Open Voltage: 11.75V, Maximum Current: 1350mA NC, NT
Micro SD Card Pin1,2,7,8	Overload	24Vac	--	--	--	Open Voltage: 2.78V, Maximum Current: 10mA NC, NT
Micro SD Card Pin3	Overload	24Vac	--	--	--	Open Voltage: 3.32V, Maximum Current: 20mA NC, NT
Micro SD Card Pin9	Overload	24Vac	--	--	--	Open Voltage: 3.00V, Maximum Current: 10mA NC, NT
General I/O terminal Pin3,4,5	Overload	24Vac	--	--	--	Open Voltage: 6.40V, Maximum Current: 10mA NC, NT
Micro SD Card Pin5,6,10-13	Overload	24Vac	--	--	--	Open Voltage: 0V, B
General I/O terminal Pin6,7	Overload	24Vac	--	--	--	Open Voltage: 0V, B
AV out All Pin	Overload	24Vac	--	--	--	Open Voltage: 0V, B
Audio in All Pin	Overload	24Vac	--	--	--	Open Voltage: 0V, B
Ethernet All Pins	Overload	24Vac	--	--	--	Open Voltage: 0V, B
supplementary information:--						
(COMPONENT FAILURE TEST; ABNORMAL OPERATION TEST; TRANSFORMER ABNORMAL OPERATION TEST) Result Abbreviations: NT - Tissue paper remained intact. CT - Constant Temperature Obtained. B - Circuit measures 0 Volts						



National Differences

EUROPEAN

* No National Differences Declared

** Only Group Difference



IEC60950_1B - ATTACHMENT			
Clause	Requirement - Test	Result - Remark	Verdict

<p>ATTACHMENT TO TEST REPORT IEC 60950-1 EUROPEAN GROUP DIFFERENCES AND NATIONAL DIFFERENCES Information technology equipment – Safety –</p> <p>Part 1: General requirements</p> <p>Differences according to.....: EN 60950-1:2006/A11:2009/A1:2010/A12:2011</p> <p>Attachment Form No......: EU_GD_IEC60950_1B_II</p> <p>Attachment Originator: SGS Fimko Ltd</p> <p>Master Attachment.....: Date 2011-08</p> <p>Copyright © 2011 IEC System for Conformity Testing and Certification of Electrical Equipment (IECEE), Geneva, Switzerland. All rights reserved.</p>			
--	--	--	--

EN 60950-1:2006/A11:2009/A1:2010/A12:2011 – CENELEC COMMON MODIFICATIONS

IEC 60950-1, GROUP DIFFERENCES (CENELEC common modifications EN)			
Clause	Requirement + Test	Result - Remark	Verdict
Contents	Add the following annexes: Annex ZA (normative) Normative references to international publications with their corresponding European publications Annex ZB (normative) Special national conditions		Pass
General	Delete all the “country” notes in the reference document (IEC 60950-1:2005) according to the following list: 1.4.8 Note 2 1.5.1 Note 2 & 3 1.5.7.1 Note 1.5.8 Note 2 1.5.9.4 Note 1.7.2.1 Note 4, 5 & 6 2.2.3 Note 2.2.4 Note 2.3.2 Note 2.3.2.1 Note 2 2.3.4 Note 2 2.6.3.3 Note 2 & 3 2.7.1 Note 2.10.3.2 Note 2 2.10.5.13 Note 3 3.2.1.1 Note 3.2.4 Note 3. 2.5.1 Note 2 4.3.6 Note 1 & 2 4.7 Note 4 4.7.2.2 Note 4.7.3.1 Note 2 5.1.7.1 Note 3 & 4 5.3.7 Note 1 6 Note 2 & 5 6.1.2.1 Note 2 6.1.2.2 Note 6.2.2 Note 6.2.2.1 Note 2 6.2.2.2 Note 7.1 Note 3 7.2 Note 7.3 Note 1 & 2 G.2.1 Note 2 Annex H Note 2		Pass
General (A1:2010)	Delete all the “country” notes in the reference document (IEC 60950-1:2005/A1:2010) according to the following list: 1.5.7.1 Note 6.1.2.1 Note 2 6.2.2.1 Note 2 EE.3 Note		N/A



IEC60950_1B - ATTACHMENT			
Clause	Requirement - Test	Result - Remark	Verdict

IEC 60950-1, GROUP DIFFERENCES (CENELEC common modifications EN)			
Clause	Requirement + Test	Result - Remark	Verdict
1.3.Z1	<p>Add the following subclause:</p> <p>1.3.Z1 Exposure to excessive sound pressure</p> <p>The apparatus shall be so designed and constructed as to present no danger when used for its intended purpose, either in normal operating conditions or under fault conditions, particularly providing protection against exposure to excessive sound pressures from headphones or earphones.</p> <p>NOTE Z1 A new method of measurement is described in EN 50332-1, Sound system equipment: Headphones and earphones associated with portable audio equipment - Maximum sound pressure level measurement methodology and limit considerations - Part 1: General method for "one package equipment", and in EN 50332-2, Sound system equipment: Headphones and earphones associated with portable audio equipment - Maximum sound pressure level measurement methodology and limit considerations - Part 2: Guidelines to associate sets with headphones coming from different manufacturers.</p>		N/A
(A12:2011)	<p>In EN 60950-1:2006/A12:2011</p> <p>Delete the addition of 1.3.Z1 / EN 60950-1:2006</p> <p>Delete the definition 1.2.3.Z1 / EN 60950-1:2006 /A1:2010</p>		Pass
1.5.1	<p>Add the following NOTE:</p> <p>NOTE Z1 The use of certain substances in electrical and electronic equipment is restricted within the EU: see Directive 2002/95/EC</p>		N/A
1.7.2.1 (A1:2010)	<p>In addition, for a PORTABLE SOUND SYSTEM, the instructions shall include a warning that excessive sound pressure from earphones and headphones can cause hearing loss.</p>		N/A
1.7.2.1 (A12:2011)	<p>In EN 60950-1:2006/A12:2011</p> <p>Delete NOTE Z1 and the addition for Portable Sound System.</p> <p>Add the following clause and annex to the existing standard and amendments.</p>		N/A
	<p>Zx Protection against excessive sound pressure from personal music players</p>		N/A



IEC60950_1B - ATTACHMENT			
Clause	Requirement - Test	Result - Remark	Verdict

IEC 60950-1, GROUP DIFFERENCES (CENELEC common modifications EN)			
Clause	Requirement + Test	Result - Remark	Verdict
	<p>Zx.1 General This sub-clause specifies requirements for protection against excessive sound pressure from personal music players that are closely coupled to the ear. It also specifies requirements for earphones and headphones intended for use with personal music players.</p> <p>A personal music player is a portable equipment for personal use, that:</p> <ul style="list-style-type: none"> – is designed to allow the user to listen to recorded or broadcast sound or video; and – primarily uses headphones or earphones that can be worn in or on or around the ears; and – allows the user to walk around while in use. <p>NOTE 1 Examples are hand-held or body-worn portable CD players, MP3 audio players, mobile phones with MP3 type features, PDA's or similar equipment.</p> <p>A personal music player and earphones or headphones intended to be used with personal music players shall comply with the requirements of this sub-clause.</p> <p>The requirements in this sub-clause are valid for music or video mode only.</p> <p>The requirements do not apply:</p> <ul style="list-style-type: none"> – while the personal music player is connected to an external amplifier; or – while the headphones or earphones are not used. <p>NOTE 2 An external amplifier is an amplifier which is not part of the personal music player or the listening device, but which is intended to play the music as a standalone music player.</p> <p>The requirements do not apply to:</p> <ul style="list-style-type: none"> – hearing aid equipment and professional equipment; <p>NOTE 3 Professional equipment is equipment sold through special sales channels. All products sold through normal electronics stores are considered not to be professional equipment.</p>		N/A
	<ul style="list-style-type: none"> – analogue personal music players (personal music players without any kind of digital processing of the sound signal) that are brought to the market before the end of 2015. <p>NOTE 4 This exemption has been allowed because this technology is falling out of use and it is expected that within a few years it will no longer exist. This exemption will not be extended to other technologies.</p> <p>For equipment which is clearly designed or intended for use by young children, the limits of EN 71-1 apply.</p>		



IEC60950_1B - ATTACHMENT			
Clause	Requirement - Test	Result - Remark	Verdict

IEC 60950-1, GROUP DIFFERENCES (CENELEC common modifications EN)			
Clause	Requirement + Test	Result - Remark	Verdict
	<p>Zx.2 Equipment requirements No safety provision is required for equipment that complies with the following:</p> <ul style="list-style-type: none"> – equipment provided as a package (personal music player with its listening device), where the acoustic output $L_{Aeq,T}$ is ≤ 85 dBA measured while playing the fixed “programme simulation noise” as described in EN 50332-1; and – a personal music player provided with an analogue electrical output socket for a listening device, where the electrical output is ≤ 27 mV measured as described in EN 50332-2, while playing the fixed “programme simulation noise” as described in EN 50332-1. <p>NOTE 1 Wherever the term acoustic output is used in this clause, the 30 s A-weighted equivalent sound pressure level $L_{Aeq,T}$ is meant. See also Zx.5 and Annex Zx.</p> <p>All other equipment shall:</p> <ul style="list-style-type: none"> a) protect the user from unintentional acoustic outputs exceeding those mentioned above; and b) have a standard acoustic output level not exceeding those mentioned above, and automatically return to an output level not exceeding those mentioned above when the power is switched off; and 		N/A



IEC60950_1B - ATTACHMENT

Clause	Requirement - Test	Result - Remark	Verdict
--------	--------------------	-----------------	---------

IEC 60950-1, GROUP DIFFERENCES (CENELEC common modifications EN)

Clause	Requirement + Test	Result - Remark	Verdict
	<p>c) provide a means to actively inform the user of the increased sound pressure when the equipment is operated with an acoustic output exceeding those mentioned above. Any means used shall be acknowledged by the user before activating a mode of operation which allows for an acoustic output exceeding those mentioned above. The acknowledgement does not need to be repeated more than once every 20 h of cumulative listening time; and</p> <p>NOTE 2 Examples of means include visual or audible signals. Action from the user is always required. NOTE 3 The 20 h listening time is the accumulative listening time, independent how often and how long the personal music player has been switched off.</p> <p>d) have a warning as specified in Zx.3; and</p> <p>e) not exceed the following:</p> <ol style="list-style-type: none"> 1) equipment provided as a package (player with its listening device), the acoustic output shall be ≤ 100 dBA measured while playing the fixed "programme simulation noise" described in EN 50332-1; and 2) a personal music player provided with an analogue electrical output socket for a listening device, the electrical output shall be ≤ 150 mV measured as described in EN 50332-2, while playing the fixed "programme simulation noise" described in EN 50332-1. <p>For music where the average sound pressure (long term $L_{Aeq,T}$) measured over the duration of the song is lower than the average produced by the programme simulation noise, the warning does not need to be given as long as the average sound pressure of the song is below the basic limit of 85 dBA. In this case T becomes the duration of the song.</p> <p>NOTE 4 Classical music typically has an average sound pressure (long term $L_{Aeq,T}$) which is much lower than the average programme simulation noise. Therefore, if the player is capable to analyse the song and compare it with the programme simulation noise, the warning does not need to be given as long as the average sound pressure of the song is below the basic limit of 85 dBA. For example, if the player is set with the programme simulation noise to 85 dBA, but the average music level of the song is only 65 dBA, there is no need to give a warning or ask an acknowledgement as long as the average sound level of the song is not above the basic limit of 85 dBA.</p>		N/A



IEC60950_1B - ATTACHMENT			
Clause	Requirement - Test	Result - Remark	Verdict

IEC 60950-1, GROUP DIFFERENCES (CENELEC common modifications EN)			
Clause	Requirement + Test	Result - Remark	Verdict
	<p>Zx.3 Warning The warning shall be placed on the equipment, or on the packaging, or in the instruction manual and shall consist of the following:</p> <ul style="list-style-type: none"> – the symbol of Figure 1 with a minimum height of 5 mm; and – the following wording, or similar: <p>“To prevent possible hearing damage, do not listen at high volume levels for long periods.”</p> <div style="text-align: center;">  </div> <p>Figure 1 – Warning label (IEC 60417-6044)</p> <p>Alternatively, the entire warning may be given through the equipment display during use, when the user is asked to acknowledge activation of the higher level.</p>		N/A
	Zx.4 Requirements for listening devices (headphones and earphones)		N/A
	<p>Zx.4.1 Wired listening devices with analogue input With 94 dBA sound pressure output $L_{Aeq,T}$, the input voltage of the fixed “programme simulation noise” described in EN 50332-2 shall be ≥ 75 mV.</p> <p>This requirement is applicable in any mode where the headphones can operate (active or passive), including any available setting (for example built-in volume level control).</p> <p>NOTE The values of 94 dBA – 75 mV correspond with 85dBA – 27 mV and 100 dBA – 150 mV.</p>		N/A



IEC60950_1B - ATTACHMENT			
Clause	Requirement - Test	Result - Remark	Verdict

IEC 60950-1, GROUP DIFFERENCES (CENELEC common modifications EN)			
Clause	Requirement + Test	Result - Remark	Verdict
	<p>Zx.4.2 Wired listening devices with digital input With any playing device playing the fixed “programme simulation noise” described in EN 50332-1 (and respecting the digital interface standards, where a digital interface standard exists that specifies the equivalent acoustic level), the acoustic output $L_{Aeq,T}$ of the listening device shall be ≤ 100 dBA.</p> <p>This requirement is applicable in any mode where the headphones can operate, including any available setting (for example built-in volume level control, additional sound feature like equalization, etc.).</p> <p>NOTE An example of a wired listening device with digital input is a USB headphone.</p>		N/A
	<p>Zx.4.3 Wireless listening devices In wireless mode: – with any playing and transmitting device playing the fixed programme simulation noise described in EN 50332-1; and – respecting the wireless transmission standards, where an air interface standard exists that specifies the equivalent acoustic level; and – with volume and sound settings in the listening device (for example built-in volume level control, additional sound feature like equalization, etc.) set to the combination of positions that maximize the measured acoustic output for the abovementioned programme simulation noise, the acoustic output $L_{Aeq,T}$ of the listening device shall be ≤ 100 dBA.</p> <p>NOTE An example of a wireless listening device is a Bluetooth headphone.</p>		N/A
	<p>Zx.5 Measurement methods Measurements shall be made in accordance with EN 50332-1 or EN 50332-2 as applicable. Unless stated otherwise, the time interval T shall be 30 s.</p> <p>NOTE Test method for wireless equipment provided without listening device should be defined.</p>		N/A
2.7.1	Replace the subclause as follows:		Pass



IEC60950_1B - ATTACHMENT			
Clause	Requirement - Test	Result - Remark	Verdict

IEC 60950-1, GROUP DIFFERENCES (CENELEC common modifications EN)									
Clause	Requirement + Test	Result - Remark	Verdict						
	<p>and earth faults in PRIMARY CIRCUITS, protective devices shall be included either as integral parts of the equipment or as parts of the building installation, subject to the following, a), b) and c):</p> <p>a) except as detailed in b) and c), protective devices necessary to comply with the requirements of 5.3 shall be included as parts of the equipment;</p> <p>b) for components in series with the mains input to the equipment such as the supply cord, appliance coupler, r.f.i. filter and switch, short-circuit and earth fault protection may be provided by protective devices in the building installation;</p> <p>c) it is permitted for PLUGGABLE EQUIPMENT TYPE B or PERMANENTLY CONNECTED EQUIPMENT, to rely on dedicated overcurrent and short-circuit protection in the building installation, provided that the means of protection, e.g. fuses or circuit breakers, is fully specified in the installation instructions.</p> <p>If reliance is placed on protection in the building installation, the installation instructions shall so state, except that for PLUGGABLE EQUIPMENT TYPE A the building installation shall be regarded as providing protection in accordance with the rating of the wall socket outlet.</p>		Pass						
2.7.2	This subclause has been declared 'void'.		N/A						
3.2.3	Delete the NOTE in Table 3A, and delete also in this table the conduit sizes in parentheses.		N/A						
3.2.5.1	<p>Replace "60245 IEC 53" by "H05 RR-F"; "60227 IEC 52" by "H03 VV-F or H03 VVH2-F"; "60227 IEC 53" by "H05 VV-F or H05 VVH2-F2".</p> <p>In Table 3B, replace the first four lines by the following:</p> <table border="0"> <tr> <td>Up to and including 6 </td> <td>0,75 ^{a)} </td> </tr> <tr> <td>Over 6 up to and including 10 (0,75) ^{b)}</td> <td>1,0 </td> </tr> <tr> <td>Over 10 up to and including 16 (1,0) ^{c)}</td> <td>1,5 </td> </tr> </table> <p>In the conditions applicable to Table 3B delete the words "in some countries" in condition ^{a)}.</p> <p>In NOTE 1, applicable to Table 3B, delete the second sentence.</p>	Up to and including 6	0,75 ^{a)}	Over 6 up to and including 10 (0,75) ^{b)}	1,0	Over 10 up to and including 16 (1,0) ^{c)}	1,5		N/A
Up to and including 6	0,75 ^{a)}								
Over 6 up to and including 10 (0,75) ^{b)}	1,0								
Over 10 up to and including 16 (1,0) ^{c)}	1,5								



IEC60950_1B - ATTACHMENT			
Clause	Requirement - Test	Result - Remark	Verdict

IEC 60950-1, GROUP DIFFERENCES (CENELEC common modifications EN)			
Clause	Requirement + Test	Result - Remark	Verdict
3.3.4	In Table 3D, delete the fourth line: conductor sizes for 10 to 13 A, and replace with the following: Over 10 up to and including 16 1,5 to 2,5 1,5 to 4 Delete the fifth line: conductor sizes for 13 to 16 A		N/A
4.3.13.6 (A1:2010)	Replace the existing NOTE by the following: NOTE Z1 Attention is drawn to: 1999/519/EC: Council Recommendation on the limitation of exposure of the general public to electromagnetic fields 0 Hz to 300 GHz, and 2006/25/EC: Directive on the minimum health and safety requirements regarding the exposure of workers to risks arising from physical agents (artificial optical radiation). Standards taking into account mentioned Recommendation and Directive which demonstrate compliance with the applicable EU Directive are indicated in the OJEC.		N/A
Annex H	Replace the last paragraph of this annex by: At any point 10 cm from the surface of the OPERATOR ACCESS AREA, the dose rate shall not exceed 1 µSv/h (0,1 mR/h) (see NOTE). Account is taken of the background level. Replace the notes as follows: NOTE These values appear in Directive 96/29/Euratom. Delete NOTE 2.		N/A
Bibliography	Additional EN standards.		—

ZA	NORMATIVE REFERENCES TO INTERNATIONAL PUBLICATIONS WITH THEIR CORRESPONDING EUROPEAN PUBLICATIONS	—
-----------	--	---

<u>ZB ANNEX (normative)</u> <u>SPECIAL NATIONAL CONDITIONS (EN)</u>			
Clause	Requirement + Test	Result - Remark	Verdict
1.2.4.1	In Denmark , certain types of Class I appliances (see 3.2.1.1) may be provided with a plug not establishing earthing conditions when inserted into Danish socket-outlets.		N/A
1.2.13.14	In Norway and Sweden , for requirements see 1.7.2.1 and 7.3 of this annex.		N/A



IEC60950_1B - ATTACHMENT			
Clause	Requirement - Test	Result - Remark	Verdict

<u>ZB ANNEX (normative)</u> <u>SPECIAL NATIONAL CONDITIONS (EN)</u>			
Clause	Requirement + Test	Result - Remark	Verdict
1.5.7.1	In Finland, Norway and Sweden , resistors bridging BASIC INSULATION in CLASS I PLUGGABLE EQUIPMENT TYPE A must comply with the requirements in 1.5.7.1. In addition when a single resistor is used, the resistor must withstand the resistor test in 1.5.7.2.		N/A
1.5.8	In Norway , due to the IT power system used (see annex V, Figure V.7), capacitors are required to be rated for the applicable line-to-line voltage (230 V).		N/A
1.5.9.4	In Finland, Norway and Sweden , the third dashed sentence is applicable only to equipment as defined in 6.1.2.2 of this annex.		N/A



IEC60950_1B - ATTACHMENT

Clause	Requirement - Test	Result - Remark	Verdict
--------	--------------------	-----------------	---------

ZB ANNEX (normative)
SPECIAL NATIONAL CONDITIONS (EN)

Clause	Requirement + Test	Result - Remark	Verdict
1.7.2.1	<p>In Finland, Norway and Sweden, CLASS I PLUGGABLE EQUIPMENT TYPE A intended for connection to other equipment or a network shall, if safety relies on connection to protective earth or if surge suppressors are connected between the network terminals and accessible parts, have a marking stating that the equipment must be connected to an earthed mains socket-outlet.</p> <p>The marking text in the applicable countries shall be as follows:</p> <p>In Finland: "Laite on liitettävä suojakoskettimilla varustettuun pistorasiaan"</p> <p>In Norway: "Apparatet må tilkoples jordet stikkontakt"</p> <p>In Sweden: "Apparaten skall anslutas till jordat uttag"</p> <p>In Norway and Sweden, the screen of the cable distribution system is normally not earthed at the entrance of the building and there is normally no equipotential bonding system within the building. Therefore the protective earthing of the building installation need to be isolated from the screen of a cable distribution system.</p> <p>It is however accepted to provide the insulation external to the equipment by an adapter or an interconnection cable with galvanic isolator, which may be provided by e.g. a retailer.</p> <p>The user manual shall then have the following or similar information in Norwegian and Swedish language respectively, depending on in what country the equipment is intended to be used in:</p> <p>"Equipment connected to the protective earthing of the building installation through the mains connection or through other equipment with a connection to protective earthing – and to a cable distribution system using coaxial cable, may in some circumstances create a fire hazard. Connection to a cable distribution system has therefore to be provided through a device providing electrical isolation below a certain frequency range (galvanic isolator, see EN 60728-11)."</p>		N/A



IEC60950_1B - ATTACHMENT			
Clause	Requirement - Test	Result - Remark	Verdict

<p align="center"><u>ZB ANNEX (normative)</u> <u>SPECIAL NATIONAL CONDITIONS (EN)</u></p>			
Clause	Requirement + Test	Result - Remark	Verdict
	<p>NOTE In Norway, due to regulation for installations of cable distribution systems, and in Sweden, a galvanic isolator shall provide electrical insulation below 5 MHz. The insulation shall withstand a dielectric strength of 1,5 kV r.m.s., 50 Hz or 60 Hz, for 1 min.</p> <p>Translation to Norwegian (the Swedish text will also be accepted in Norway): "Utstyr som er koplet til beskyttelsesjord via nettplugg og/eller via annet jordtilkoplede utstyr – og er tilkoplede et kabel-TV nett, kan forårsake brannfare. For å unngå dette skal det ved tilkopling av utstyret til kabel-TV nettet installeres en galvanisk isolator mellom utstyret og kabel- TV nettet." Translation to Swedish: "Utrustning som är kopplad till skyddsjord via jordat vägguttag och/eller via annan utrustning och samtidigt är kopplad till kabel-TV nät kan i vissa fall medföra risk för brand. För att undvika detta skall vid anslutning av utrustningen till kabel-TV nät galvanisk isolator finnas mellan utrustningen och kabel-TV nätet."</p>		N/A
1.7.5	<p>In Denmark, socket-outlets for providing power to other equipment shall be in accordance with the Heavy Current Regulations, Section 107-2-D1, Standard Sheet DK 1-3a, DK 1-5a or DK 1-7a, when used on Class I equipment. For STATIONARY EQUIPMENT the socket-outlet shall be in accordance with Standard Sheet DK 1-1b or DK 1-5a.</p> <p>For CLASS II EQUIPMENT the socket outlet shall be in accordance with Standard Sheet DKA 1-4a.</p>		N/A
2.2.4	<p>In Norway, for requirements see 1.7.2.1, 6.1.2.1 and 6.1.2.2 of this annex.</p>		N/A
2.3.2	<p>In Finland, Norway and Sweden there are additional requirements for the insulation. See 6.1.2.1 and 6.1.2.2 of this annex.</p>		N/A
2.3.4	<p>In Norway, for requirements see 1.7.2.1, 6.1.2.1 and 6.1.2.2 of this annex.</p>		N/A
2.6.3.3	<p>In the United Kingdom, the current rating of the circuit shall be taken as 13 A, not 16 A.</p>		N/A



IEC60950_1B - ATTACHMENT			
Clause	Requirement - Test	Result - Remark	Verdict

<p align="center"><u>ZB ANNEX (normative)</u> <u>SPECIAL NATIONAL CONDITIONS (EN)</u></p>			
Clause	Requirement + Test	Result - Remark	Verdict
2.7.1	In the United Kingdom , to protect against excessive currents and short-circuits in the PRIMARY CIRCUIT of DIRECT PLUG-IN EQUIPMENT, tests according to 5.3 shall be conducted, using an external protective device rated 30 A or 32 A. If these tests fail, suitable protective devices shall be included as integral parts of the DIRECT PLUG-IN EQUIPMENT, so that the requirements of 5.3 are met.		N/A
2.10.5.13	In Finland, Norway and Sweden , there are additional requirements for the insulation, see 6.1.2.1 and 6.1.2.2 of this annex.		N/A
3.2.1.1	<p>In Switzerland, supply cords of equipment having a RATED CURRENT not exceeding 10 A shall be provided with a plug complying with SEV 1011 or IEC 60884-1 and one of the following dimension sheets:</p> <p>SEV 6532-2.1991 Plug Type 15 3P+N+PE 250/400 V, 10 A</p> <p>SEV 6533-2.1991 Plug Type 11 L+N 250 V, 10 A</p> <p>SEV 6534-2.1991 Plug Type 12 L+N+PE 250 V, 10 A</p> <p>In general, EN 60309 applies for plugs for currents exceeding 10 A. However, a 16 A plug and socket-outlet system is being introduced in Switzerland, the plugs of which are according to the following dimension sheets, published in February 1998:</p> <p>SEV 5932-2.1998: Plug Type 25 , 3L+N+PE 230/400 V, 16 A</p> <p>SEV 5933-2.1998: Plug Type 21, L+N, 250 V, 16A</p> <p>SEV 5934-2.1998: Plug Type 23, L+N+PE 250 V, 16 A</p>		N/A



IEC60950_1B - ATTACHMENT			
Clause	Requirement - Test	Result - Remark	Verdict

<u>ZB ANNEX (normative)</u> <u>SPECIAL NATIONAL CONDITIONS (EN)</u>			
Clause	Requirement + Test	Result - Remark	Verdict
3.2.1.1	<p>In Denmark, supply cords of single-phase equipment having a rated current not exceeding 13 A shall be provided with a plug according to the Heavy Current Regulations, Section 107-2-D1.</p> <p>CLASS I EQUIPMENT provided with socket-outlets with earth contacts or which are intended to be used in locations where protection against indirect contact is required according to the wiring rules shall be provided with a plug in accordance with standard sheet DK 2-1a or DK 2-5a.</p> <p>If poly-phase equipment and single-phase equipment having a RATED CURRENT exceeding 13 A is provided with a supply cord with a plug, this plug shall be in accordance with the Heavy Current Regulations, Section 107-2-D1 or EN 60309-2.</p>		N/A
3.2.1.1	<p>In Spain, supply cords of single-phase equipment having a rated current not exceeding 10 A shall be provided with a plug according to UNE 20315:1994.</p> <p>Supply cords of single-phase equipment having a rated current not exceeding 2,5 A shall be provided with a plug according to UNE-EN 50075:1993.</p> <p>CLASS I EQUIPMENT provided with socket-outlets with earth contacts or which are intended to be used in locations where protection against indirect contact is required according to the wiring rules, shall be provided with a plug in accordance with standard UNE 20315:1994.</p> <p>If poly-phase equipment is provided with a supply cord with a plug, this plug shall be in accordance with UNE-EN 60309-2.</p>		N/A
3.2.1.1	<p>In the United Kingdom, apparatus which is fitted with a flexible cable or cord and is designed to be connected to a mains socket conforming to BS 1363 by means of that flexible cable or cord and plug, shall be fitted with a 'standard plug' in accordance with Statutory Instrument 1768:1994 - The Plugs and Sockets etc. (Safety) Regulations 1994, unless exempted by those regulations.</p> <p>NOTE 'Standard plug' is defined in SI 1768:1994 and essentially means an approved plug conforming to BS 1363 or an approved conversion plug.</p>		N/A



IEC60950_1B - ATTACHMENT			
Clause	Requirement - Test	Result - Remark	Verdict

<u>ZB ANNEX (normative)</u> <u>SPECIAL NATIONAL CONDITIONS (EN)</u>			
Clause	Requirement + Test	Result - Remark	Verdict
3.2.1.1	In Ireland , apparatus which is fitted with a flexible cable or cord and is designed to be connected to a mains socket conforming to I.S. 411 by means of that flexible cable or cord and plug, shall be fitted with a 13 A plug in accordance with Statutory Instrument 525:1997 - National Standards Authority of Ireland (section 28) (13 A Plugs and Conversion Adaptors for Domestic Use) Regulations 1997.		N/A
3.2.4	In Switzerland , for requirements see 3.2.1.1 of this annex.		N/A
3.2.5.1	In the United Kingdom , a power supply cord with conductor of 1,25 mm ² is allowed for equipment with a rated current over 10 A and up to and including 13 A.		N/A
3.3.4	In the United Kingdom , the range of conductor sizes of flexible cords to be accepted by terminals for equipment with a RATED CURRENT of over 10 A up to and including 13 A is: • 1,25 mm ² to 1,5 mm ² nominal cross-sectional area.		N/A
4.3.6	In the United Kingdom , the torque test is performed using a socket outlet complying with BS 1363 part 1:1995, including Amendment 1:1997 and Amendment 2:2003 and the plug part of DIRECT PLUG-IN EQUIPMENT shall be assessed to BS 1363: Part 1, 12.1, 12.2, 12.3, 12.9, 12.11, 12.12, 12.13, 12.16 and 12.17, except that the test of 12.17 is performed at not less than 125 °C. Where the metal earth pin is replaced by an Insulated Shutter Opening Device (ISOD), the requirements of clauses 22.2 and 23 also apply.		N/A
4.3.6	In Ireland , DIRECT PLUG-IN EQUIPMENT is known as plug similar devices. Such devices shall comply with Statutory Instrument 526:1997 - National Standards Authority of Ireland (Section 28) (Electrical plugs, plug similar devices and sockets for domestic use) Regulations, 1997.		N/A



IEC60950_1B - ATTACHMENT

Clause	Requirement - Test	Result - Remark	Verdict
--------	--------------------	-----------------	---------

ZB ANNEX (normative)
SPECIAL NATIONAL CONDITIONS (EN)

Clause	Requirement + Test	Result - Remark	Verdict
5.1.7.1	<p>In Finland, Norway and Sweden TOUCH CURRENT measurement results exceeding 3,5 mA r.m.s. are permitted only for the following equipment:</p> <ul style="list-style-type: none"> • STATIONARY PLUGGABLE EQUIPMENT TYPE A that is intended to be used in a RESTRICTED ACCESS LOCATION where equipotential bonding has been applied, for example, in a telecommunication centre; and has provision for a permanently connected PROTECTIVE EARTHING CONDUCTOR; and is provided with instructions for the installation of that conductor by a SERVICE PERSON; • STATIONARY PLUGGABLE EQUIPMENT TYPE B; • STATIONARY PERMANENTLY CONNECTED EQUIPMENT. 		N/A



IEC60950_1B - ATTACHMENT

Clause	Requirement - Test	Result - Remark	Verdict
--------	--------------------	-----------------	---------

ZB ANNEX (normative)
SPECIAL NATIONAL CONDITIONS (EN)

Clause	Requirement + Test	Result - Remark	Verdict
6.1.2.1 (A1:2010)	<p>In Finland, Norway and Sweden, add the following text between the first and second paragraph of the compliance clause:</p> <p>If this insulation is solid, including insulation forming part of a component, it shall at least consist of either</p> <ul style="list-style-type: none"> - two layers of thin sheet material, each of which shall pass the electric strength test below, or - one layer having a distance through insulation of at least 0,4 mm, which shall pass the electric strength test below. <p>Alternatively for components, there is no distance through insulation requirements for the insulation consisting of an insulating compound completely filling the casing, so that CLEARANCES and CREEPAGE DISTANCES do not exist, if the component passes the electric strength test in accordance with the compliance clause below and in addition</p> <ul style="list-style-type: none"> - passes the tests and inspection criteria of 2.10.11 with an electric strength test of 1,5 kV multiplied by 1,6 (the electric strength test of 2.10.10 shall be performed using 1,5 kV), and - is subject to ROUTINE TESTING for electric strength during manufacturing, using a test voltage of 1,5 kV. 		N/A



IEC60950_1B - ATTACHMENT			
Clause	Requirement - Test	Result - Remark	Verdict

<u>ZB ANNEX (normative)</u> <u>SPECIAL NATIONAL CONDITIONS (EN)</u>			
Clause	Requirement + Test	Result - Remark	Verdict
	<p>It is permitted to bridge this insulation with an optocoupler complying with 2.10.5.4 b).</p> <p>It is permitted to bridge this insulation with a capacitor complying with EN 60384-14:2005, subclass Y2.</p> <p>A capacitor classified Y3 according to EN 60384-14:2005, may bridge this insulation under the following conditions:</p> <ul style="list-style-type: none"> - the insulation requirements are satisfied by having a capacitor classified Y3 as defined by EN 60384-14, which in addition to the Y3 testing, is tested with an impulse test of 2,5 kV defined in EN 60950-1:2006, 6.2.2.1; - the additional testing shall be performed on all the test specimens as described in EN 60384-14: - the impulse test of 2,5 kV is to be performed before the endurance test in EN 60384-14, in the sequence of tests as described in EN 60384-14. 		N/A
6.1.2.2	In Finland, Norway and Sweden , the exclusions are applicable for PERMANENTLY CONNECTED EQUIPMENT, PLUGGABLE EQUIPMENT TYPE B and equipment intended to be used in a RESTRICTED ACCESS LOCATION where equipotential bonding has been applied, e.g. in a telecommunication centre, and which has provision for a permanently connected PROTECTIVE EARTHING CONDUCTOR and is provided with instructions for the installation of that conductor by a SERVICE PERSON.		N/A
7.2	In Finland, Norway and Sweden , for requirements see 6.1.2.1 and 6.1.2.2 of this annex. The term TELECOMMUNICATION NETWORK in 6.1.2 being replaced by the term CABLE DISTRIBUTION SYSTEM.		N/A
7.3	In Norway and Sweden , for requirements see 1.2.13.14 and 1.7.2.1 of this annex.		N/A
7.3	In Norway , for installation conditions see EN 60728-11:2005.		N/A





Enclosures



<u>Type</u>	<u>Supplement Id</u>	<u>Description</u>
Marking Plate	13-01	Label
Photographs	3-01	Overall view-1 (for model FD8135H)
Photographs	3-02	Overall View-2 (for model FD8135H)
Photographs	3-03	Overall view-1 (for model FD8335H)
Photographs	3-04	Overall View-2 (for model FD8335H)
Photographs	3-05	Connector View
Photographs	3-06	Internal View - 1 (for model FD8135H)
Photographs	3-07	Internal View - 2 (for model FD8135H)
Photographs	3-08	Internal View - 3 (for model FD8135H)
Photographs	3-09	Internal View - 4 (for model FD8135H)
Photographs	3-10	Internal View - 1 (for model FD8335H)
Photographs	3-11	Internal View - 2 (for model FD8335H)
Photographs	3-12	Internal View - 3 (for model FD8335H)
Photographs	3-13	Internal View - 4 (for model FD8335H)
Photographs	3-14	Mainboard top side view (for model FD8135H)
Photographs	3-15	Mainboard bottom side view (for model FD8135H)
Photographs	3-16	Mainboard top side view (for model FD8335H)
Photographs	3-17	Mainboard bottom side view (for model FD8335H)
Photographs	3-18	I/O board top side view
Photographs	3-19	I/O board bottom side view
Photographs	3-20	SENSOR board top side view
Photographs	3-21	SENSOR board bottom side view
Photographs	3-22	Wall Mount fixture-1 front view (for model FD8135H, FD8335H)
Photographs	3-23	Wall Mount fixture-2 top side view (for model FD8135H)
Photographs	3-24	Wall Mount fixture-2 bottom side view (for model FD8135H)
Photographs	3-25	Wall Mount fixture-3 top side view (for model FD8335H)
Photographs	3-26	Wall Mount fixture-3 bottom side view (for model FD8335H)
Diagrams	4-01	Enclosure Drawing for model FD8335H
Diagrams	4-02	Enclosure Drawing for model FD8135H
Diagrams	4-03	Oring Drawing for model FD8335H
Schematics + PWB		
Manuals		
Miscellaneous	7-01	LETTER REPORT FOR IP66 EVALUATION ON NETWORK CAMERA, MODEL FD8335H







Marking Plate ID 13-01

Network Camera 

Model No: FD8135H
 MAC:0002D1XXXXXX

 
 XXXXX

 **RoHS**

This device complies with Part 15 of the FCC Rules. Operation is subject to the following two conditions:
 (1) this device may not cause harmful interference, and
 (2) this device must accept any interference received, including interference that may cause undesired operation.

Pat.6930,709 Made in Taiwan

Network Camera 

Model No:FD8335H
 MAC:0002D1XXXXXX

 
 XXXXX

 **RoHS**

This device complies with part 15 of the FCC Rules. Operation is subject to the following two conditions:
 (1) this device may not cause harmful interference, and
 (2) this device must accept any interference received, including interference that may cause undesired operation.

Pat.6, 930, 709 Made in Taiwan



Photographs ID 3-01



Photographs ID 3-02

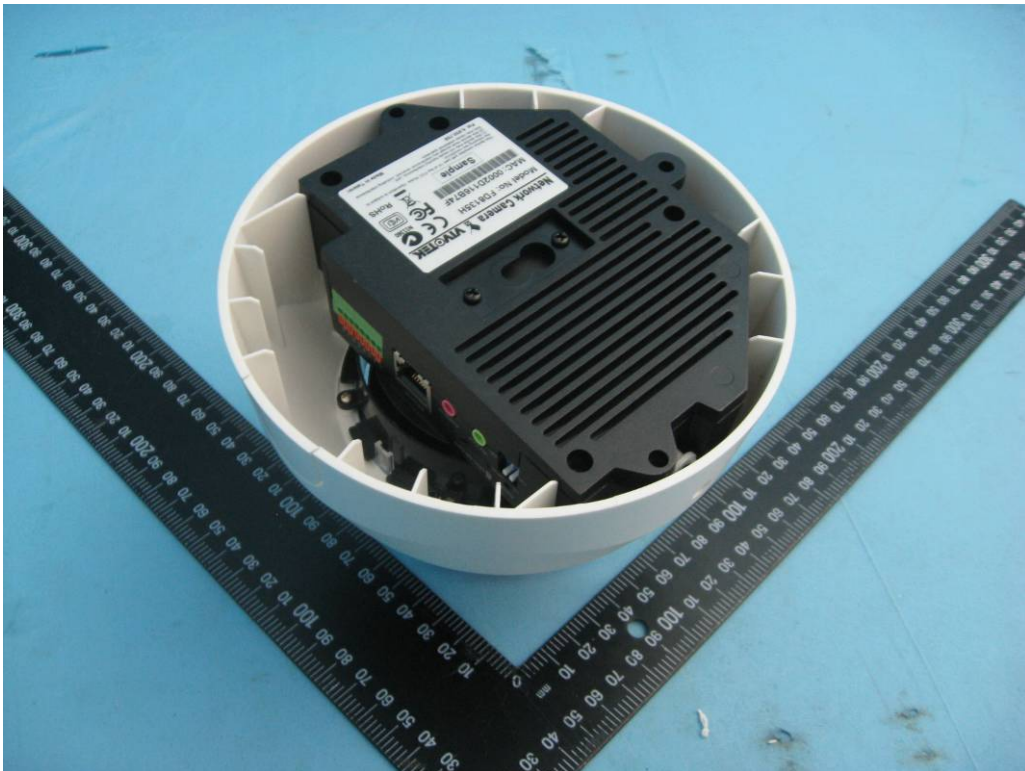



Photographs ID 3-03



Photographs ID 3-04

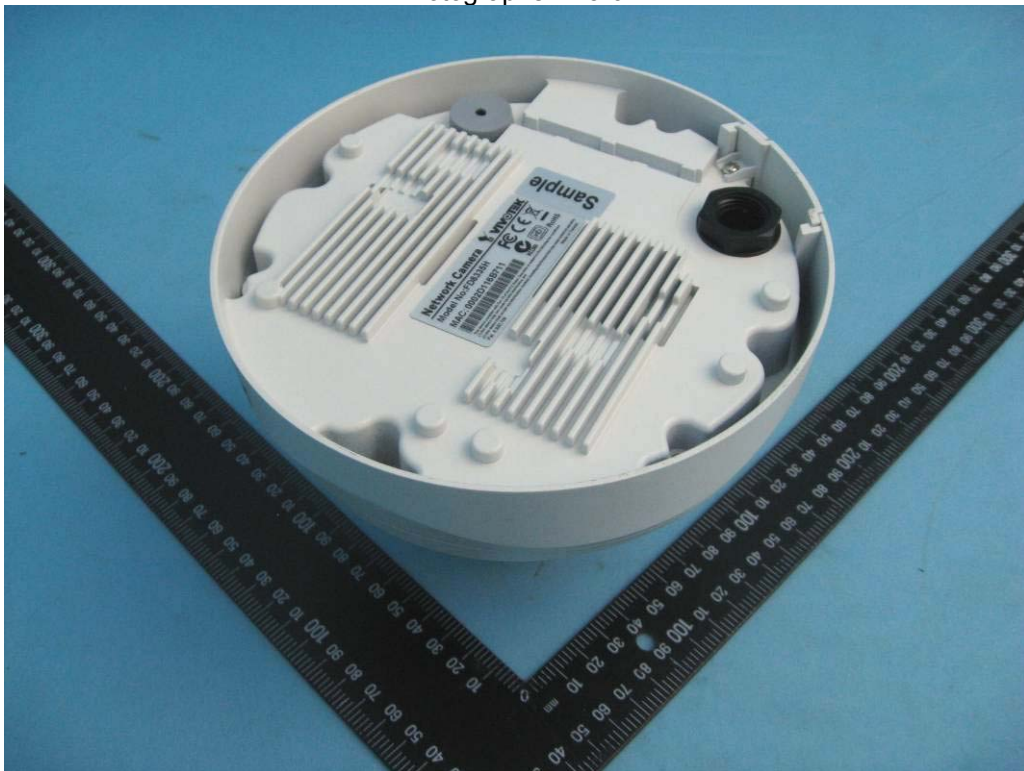



Photographs ID 3-05



Photographs ID 3-06

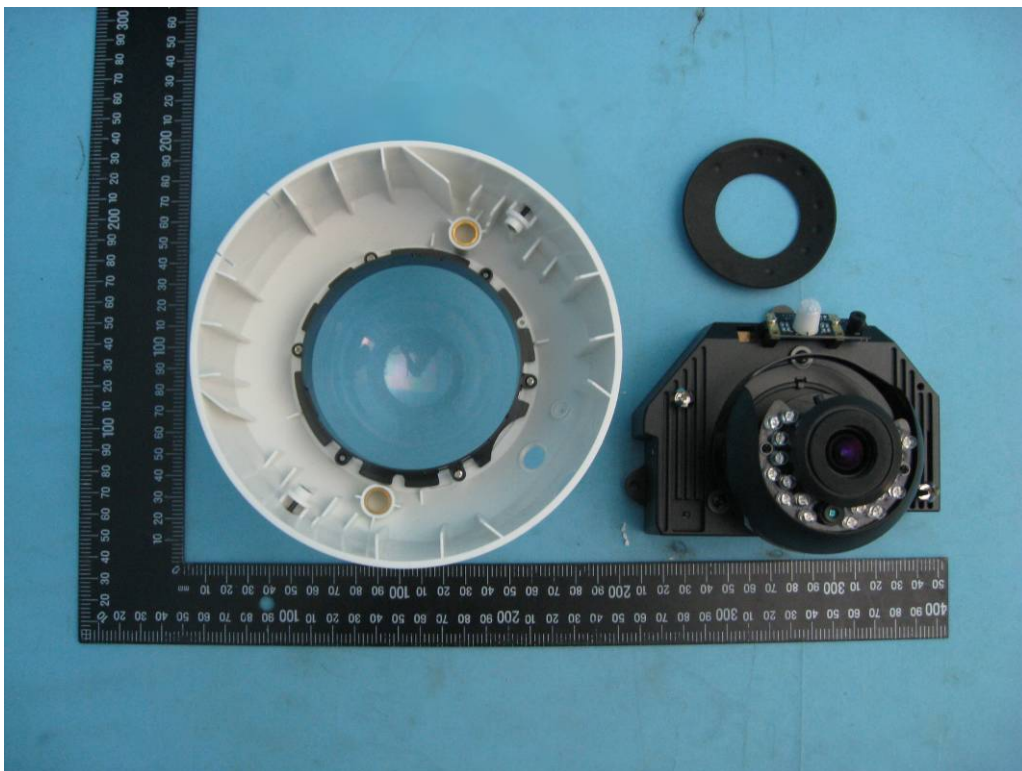



Photographs ID 3-07

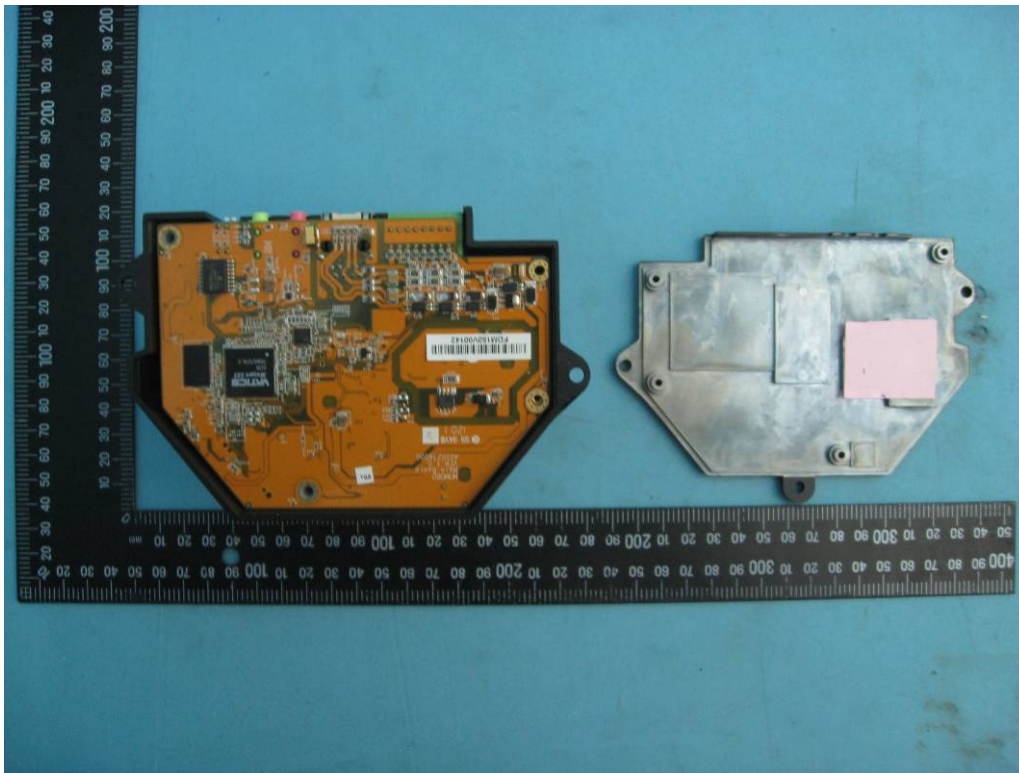

Photographs ID 3-08

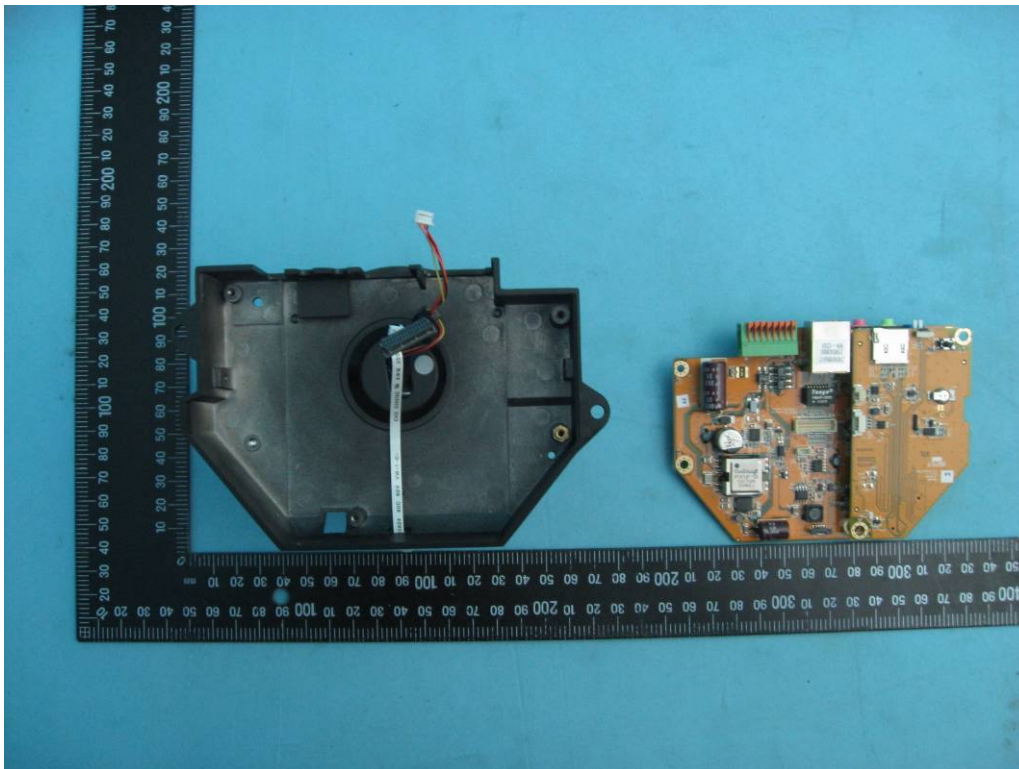



Photographs ID 3-09

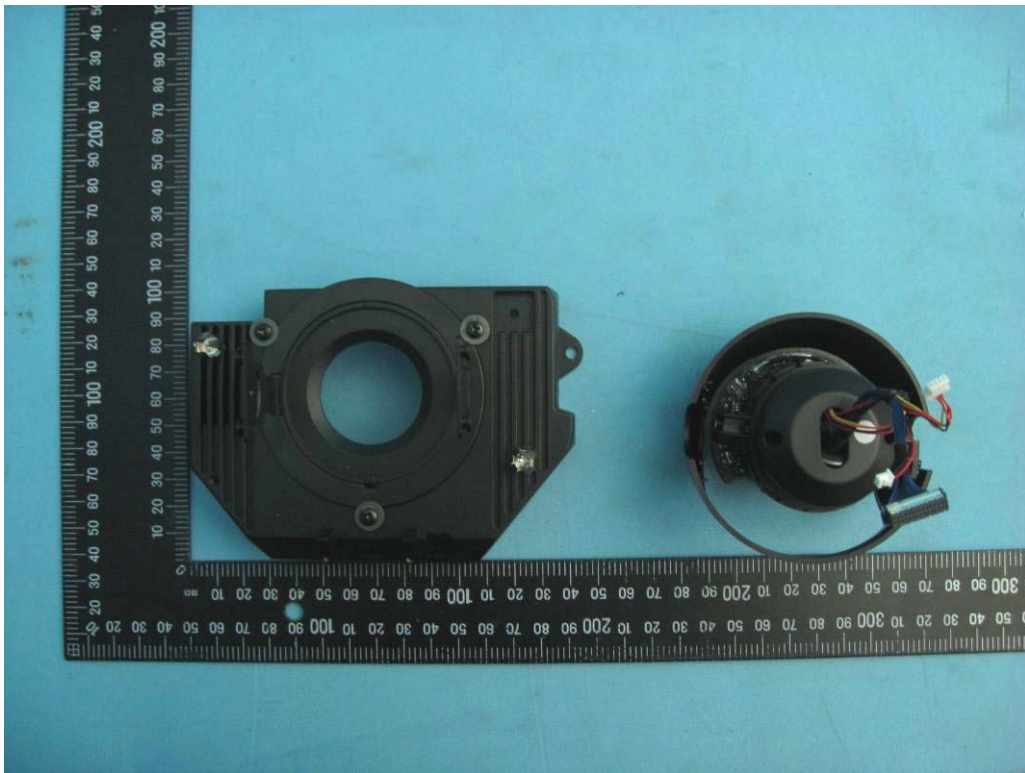

Photographs ID 3-10





Photographs ID 3-11



Photographs ID 3-12

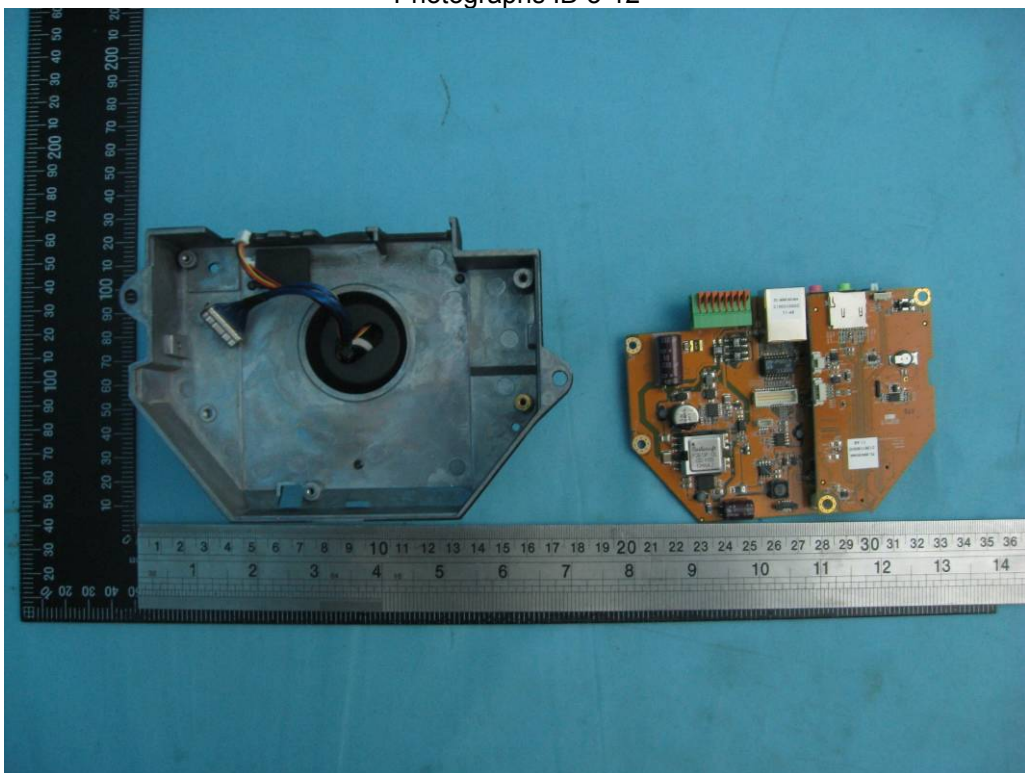



Photographs ID 3-13

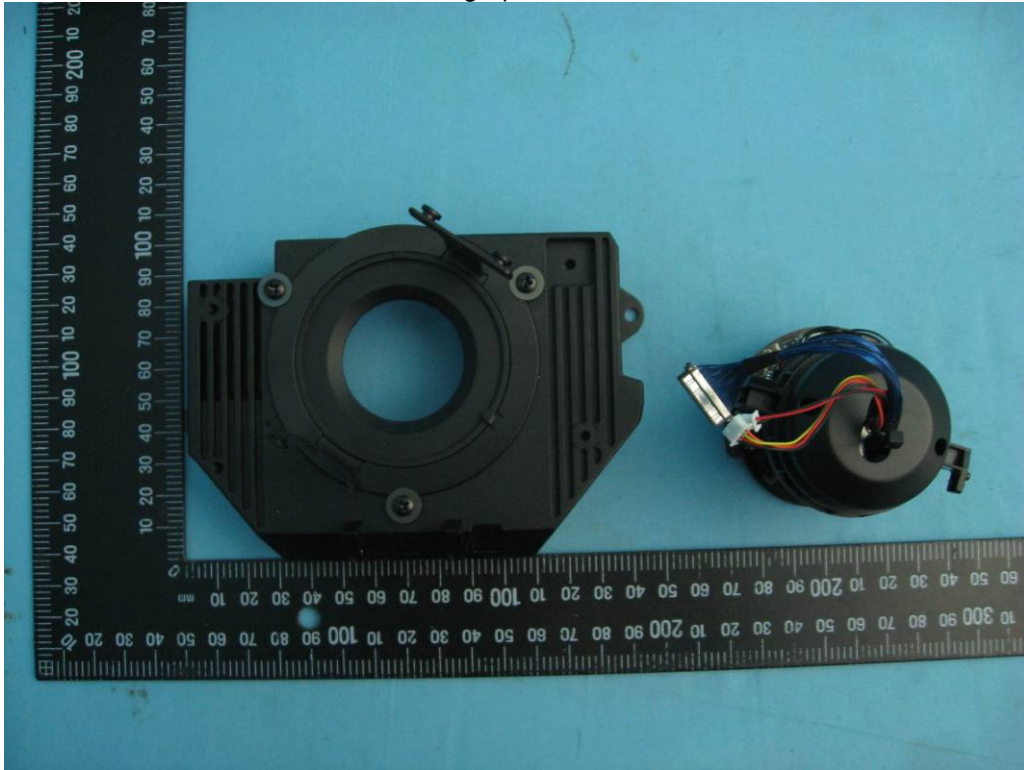

Photographs ID 3-14

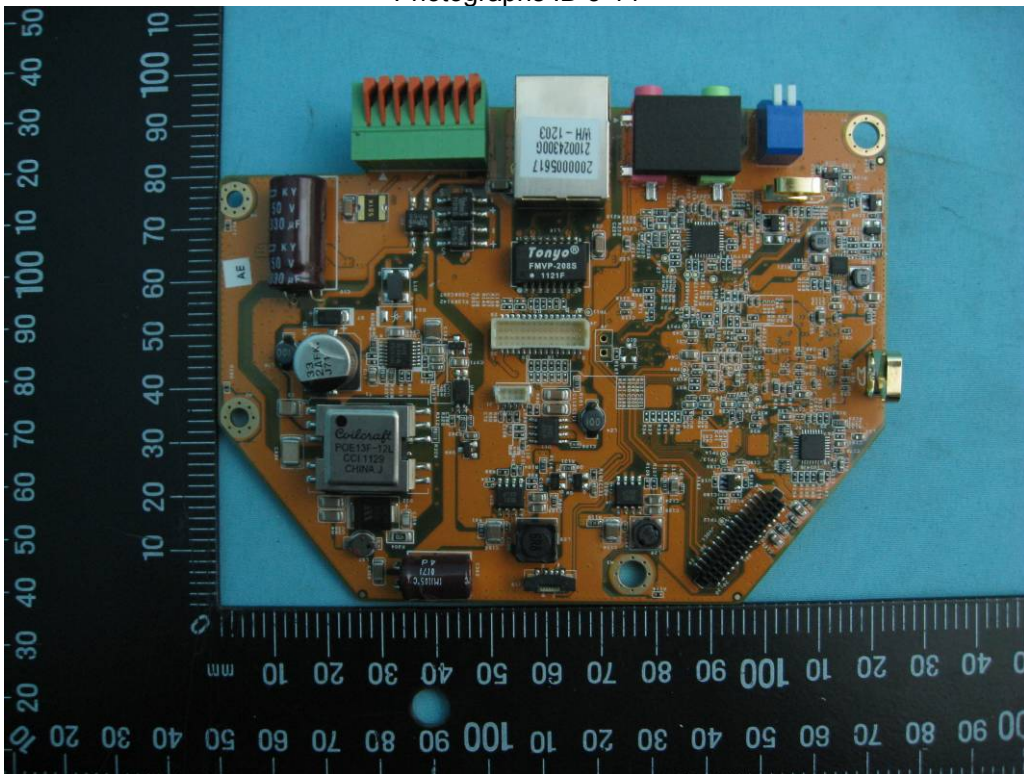



Photographs ID 3-15

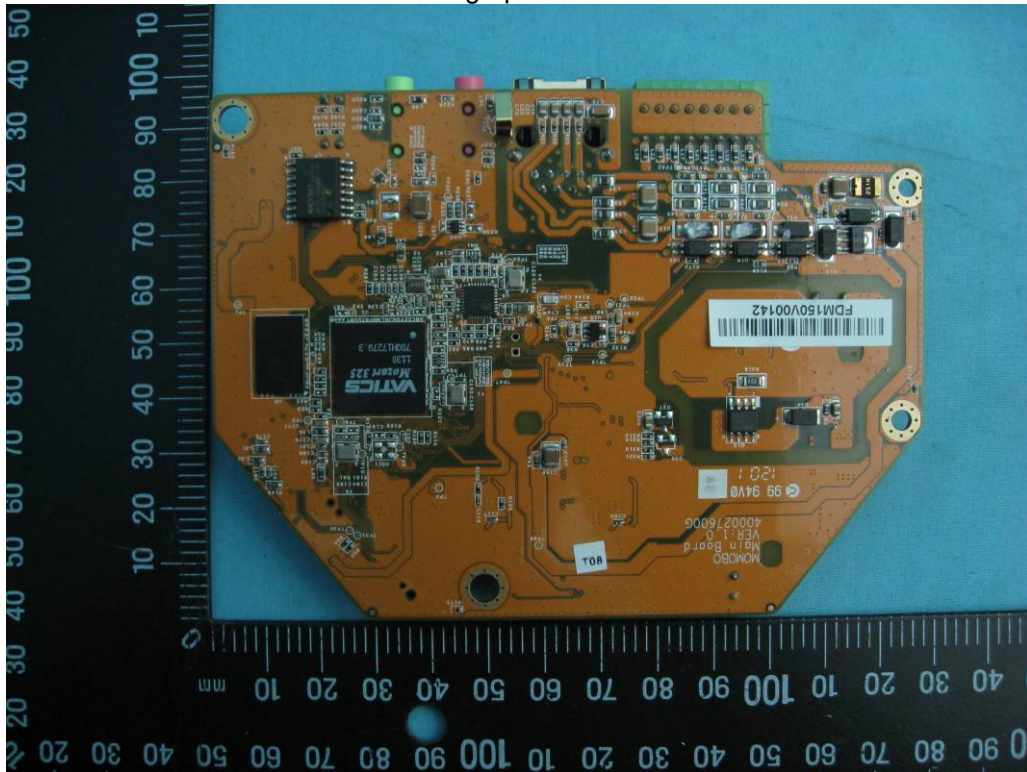

Photographs ID 3-16

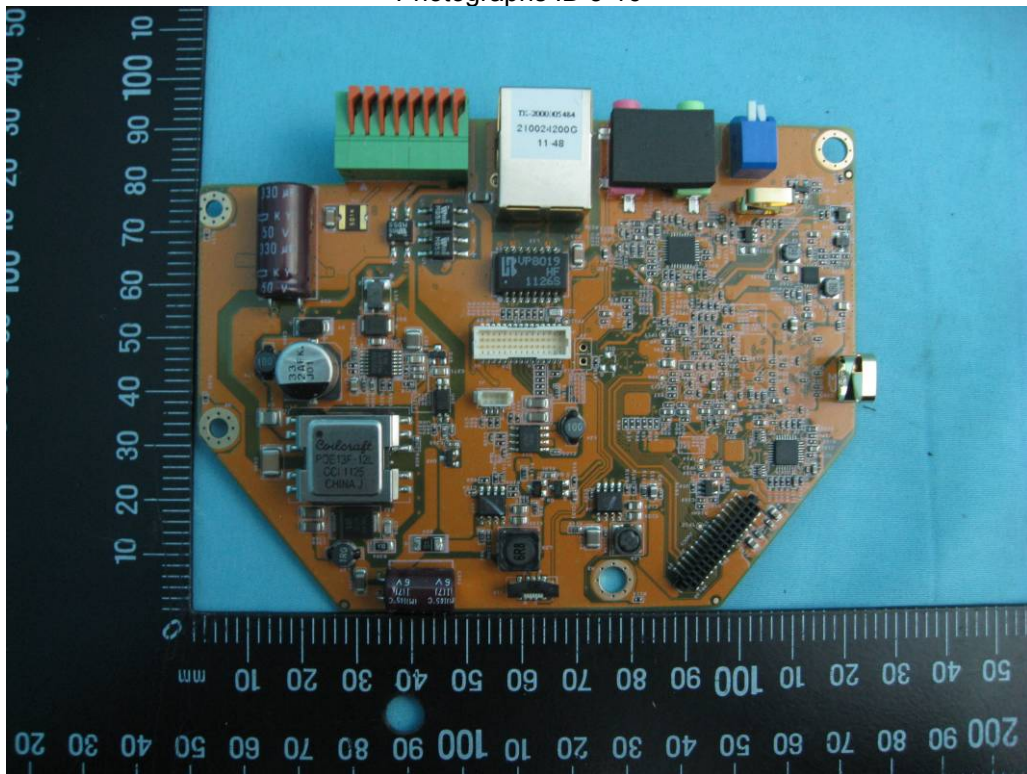



Photographs ID 3-19

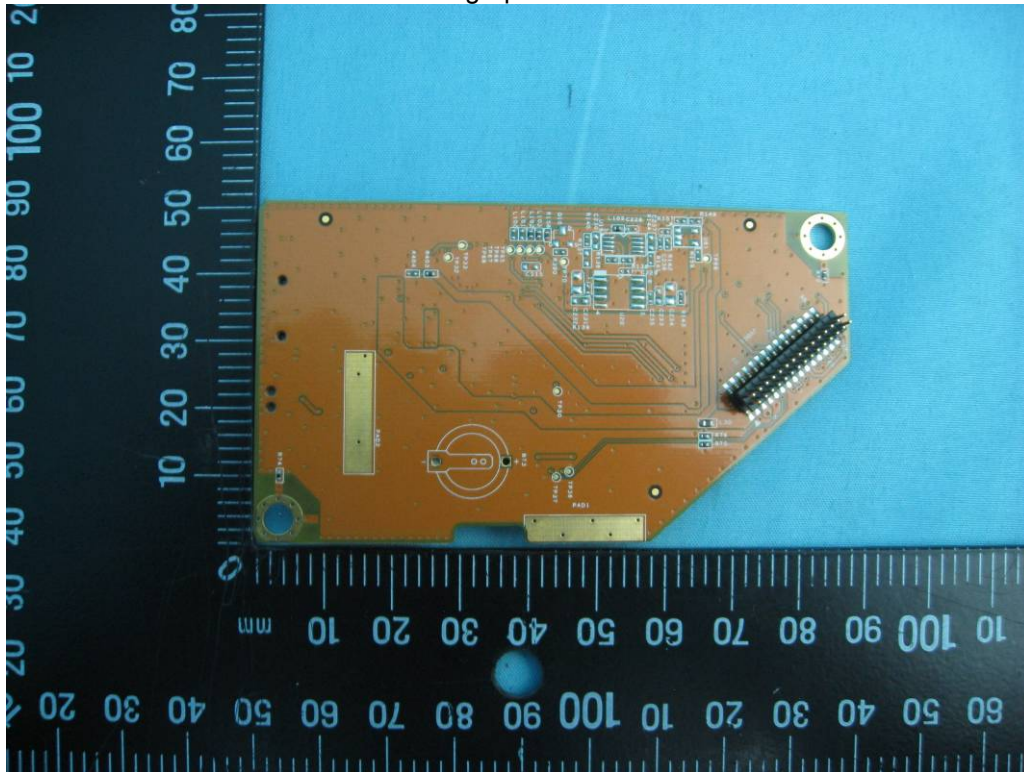

Photographs ID 3-20

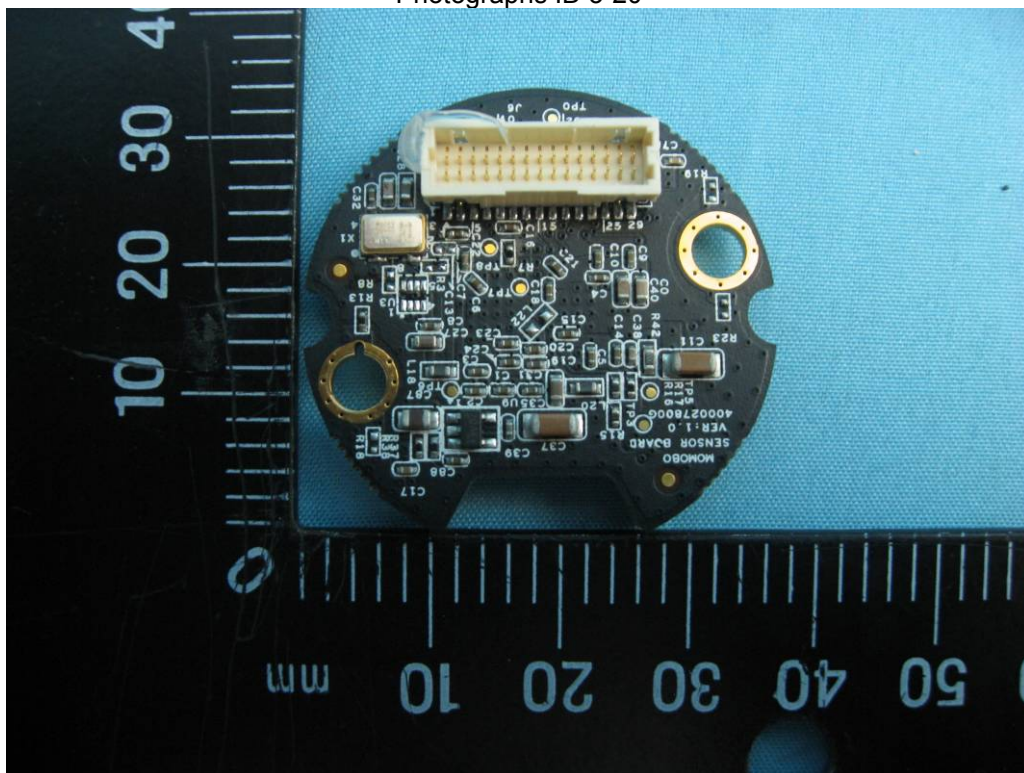



Photographs ID 3-21

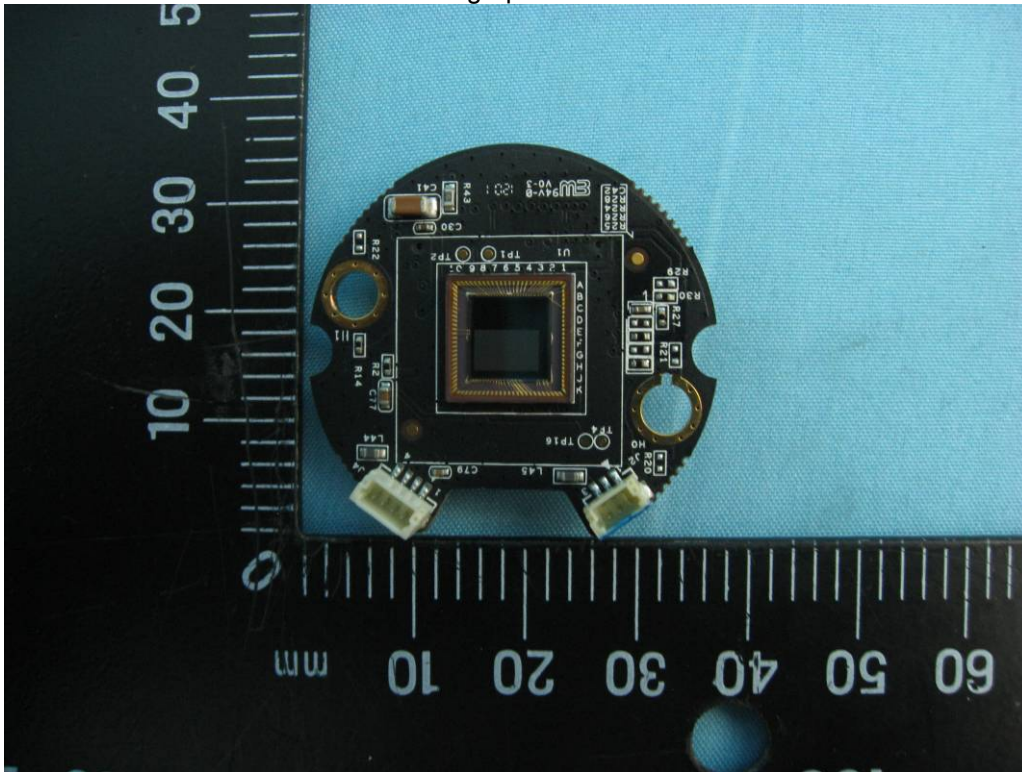

Photographs ID 3-22





Photographs ID 3-23

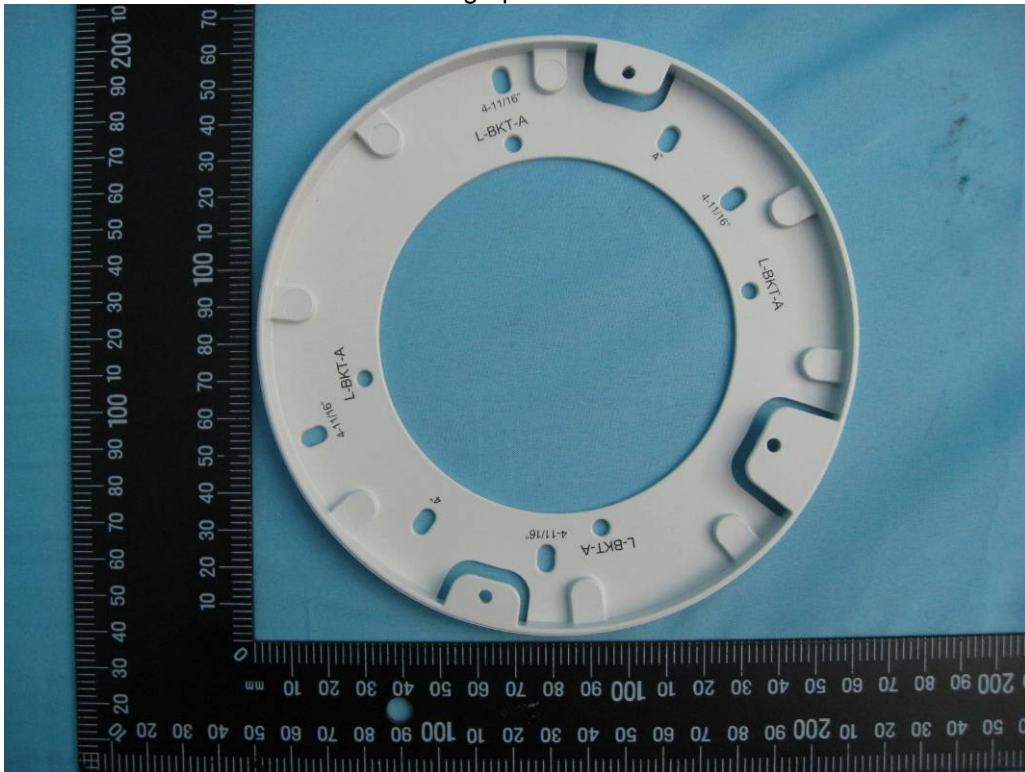

Photographs ID 3-24

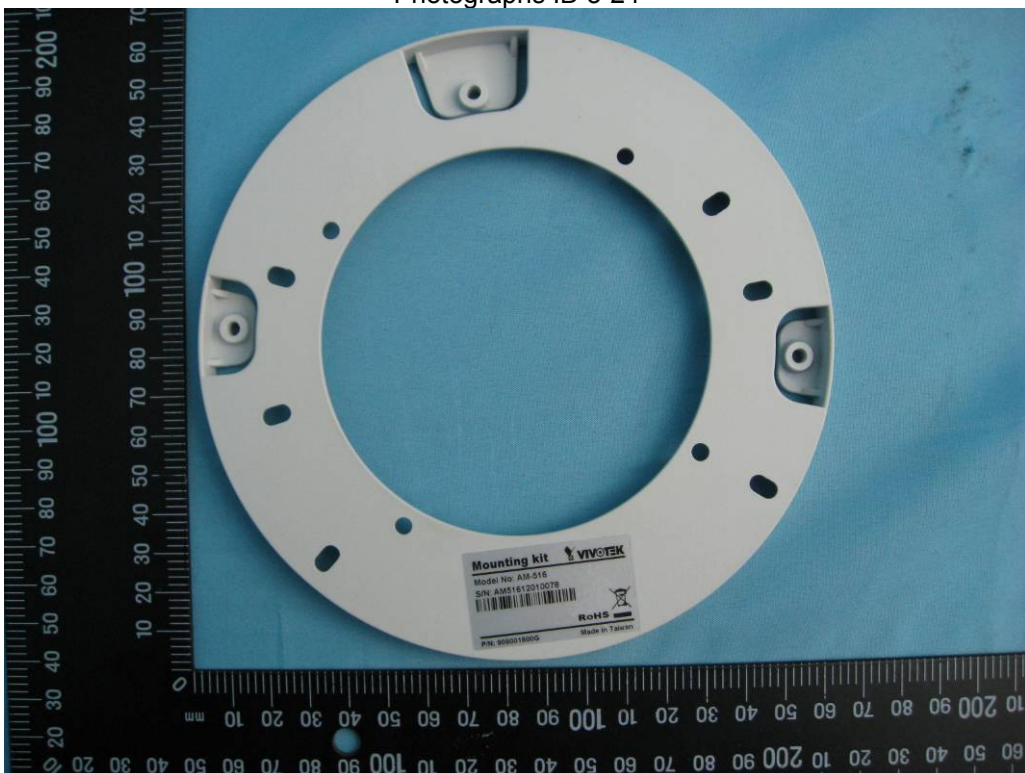



Photographs ID 3-25

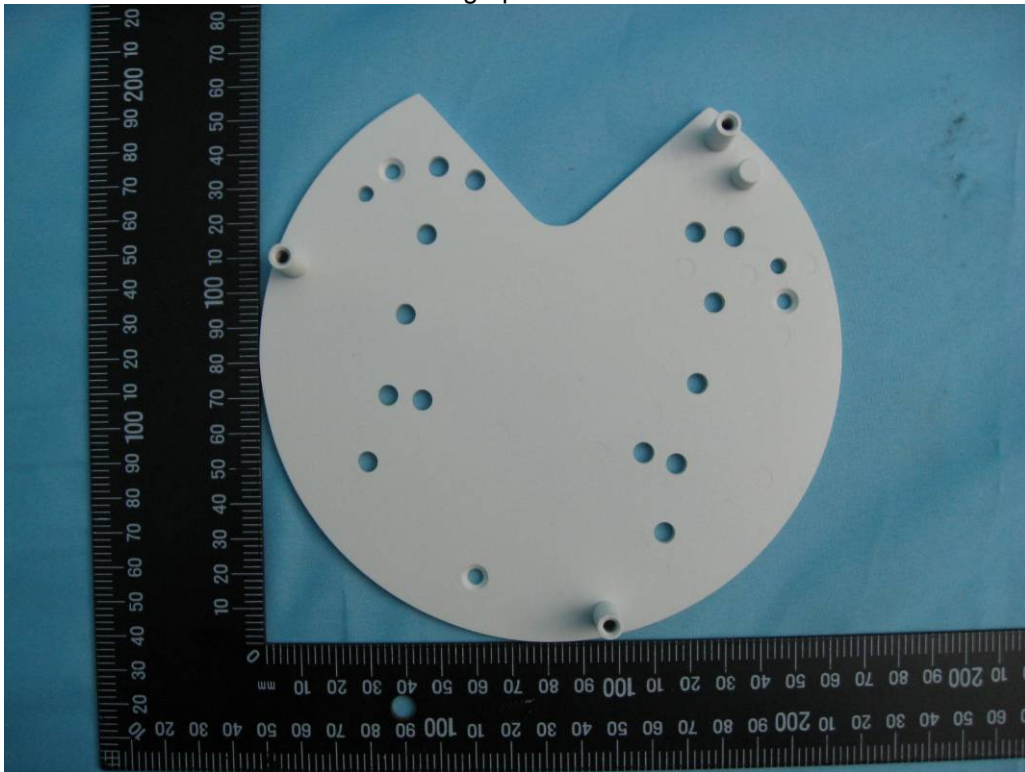

Photographs ID 3-26

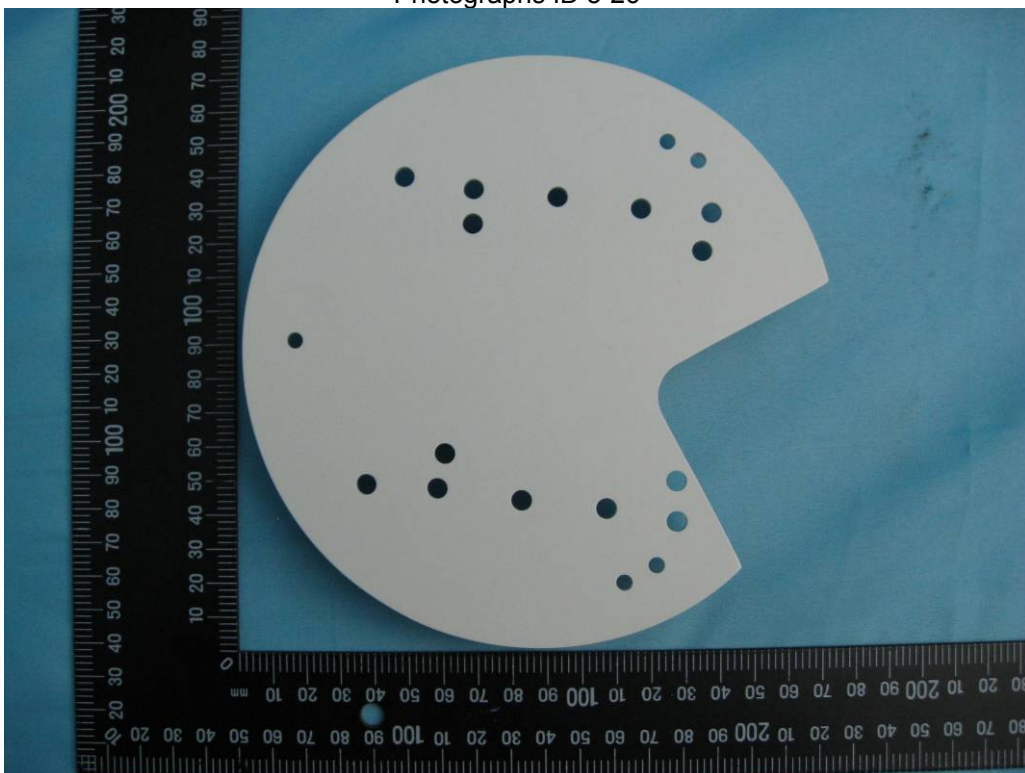



Diagrams ID 4-01

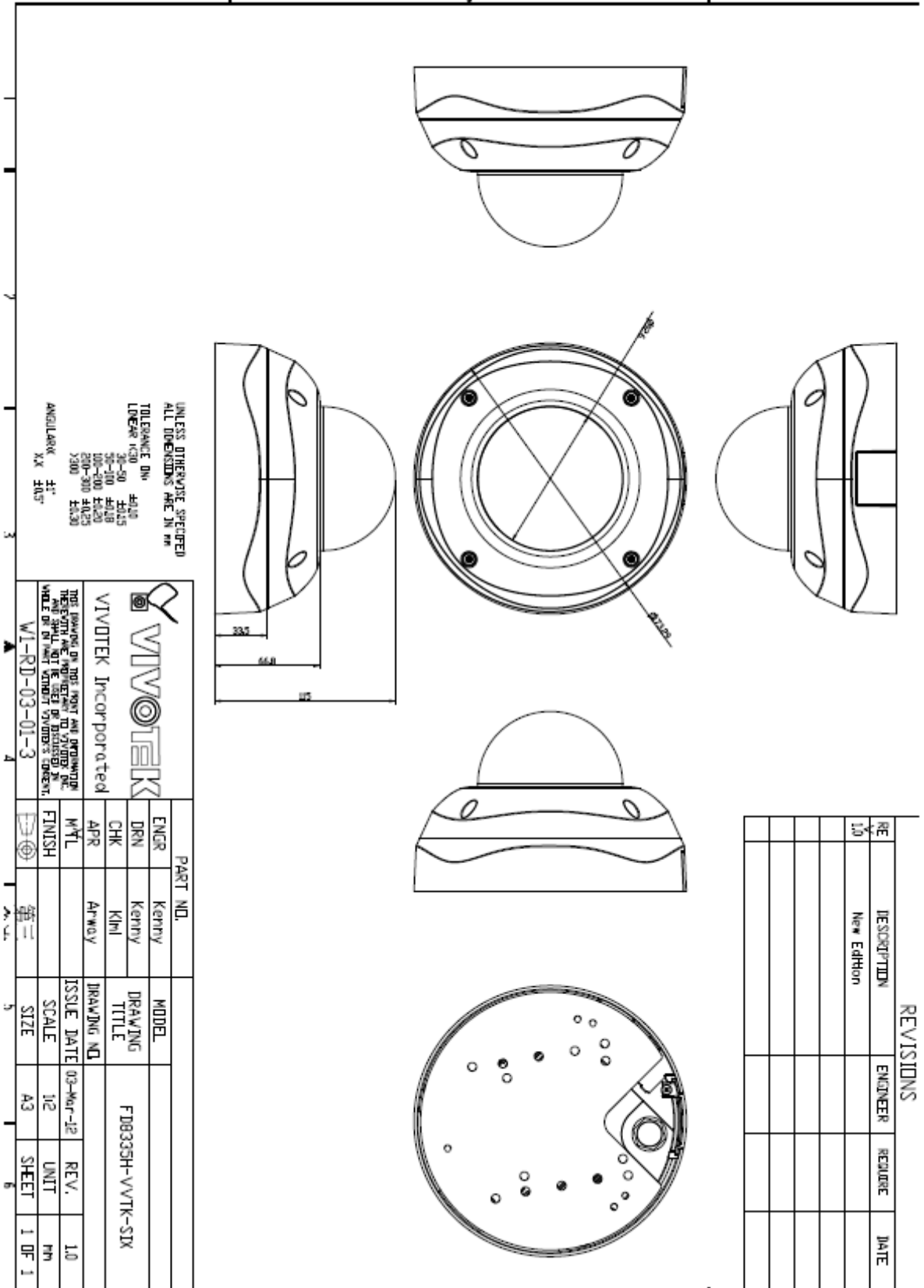



Diagrams ID 4-01

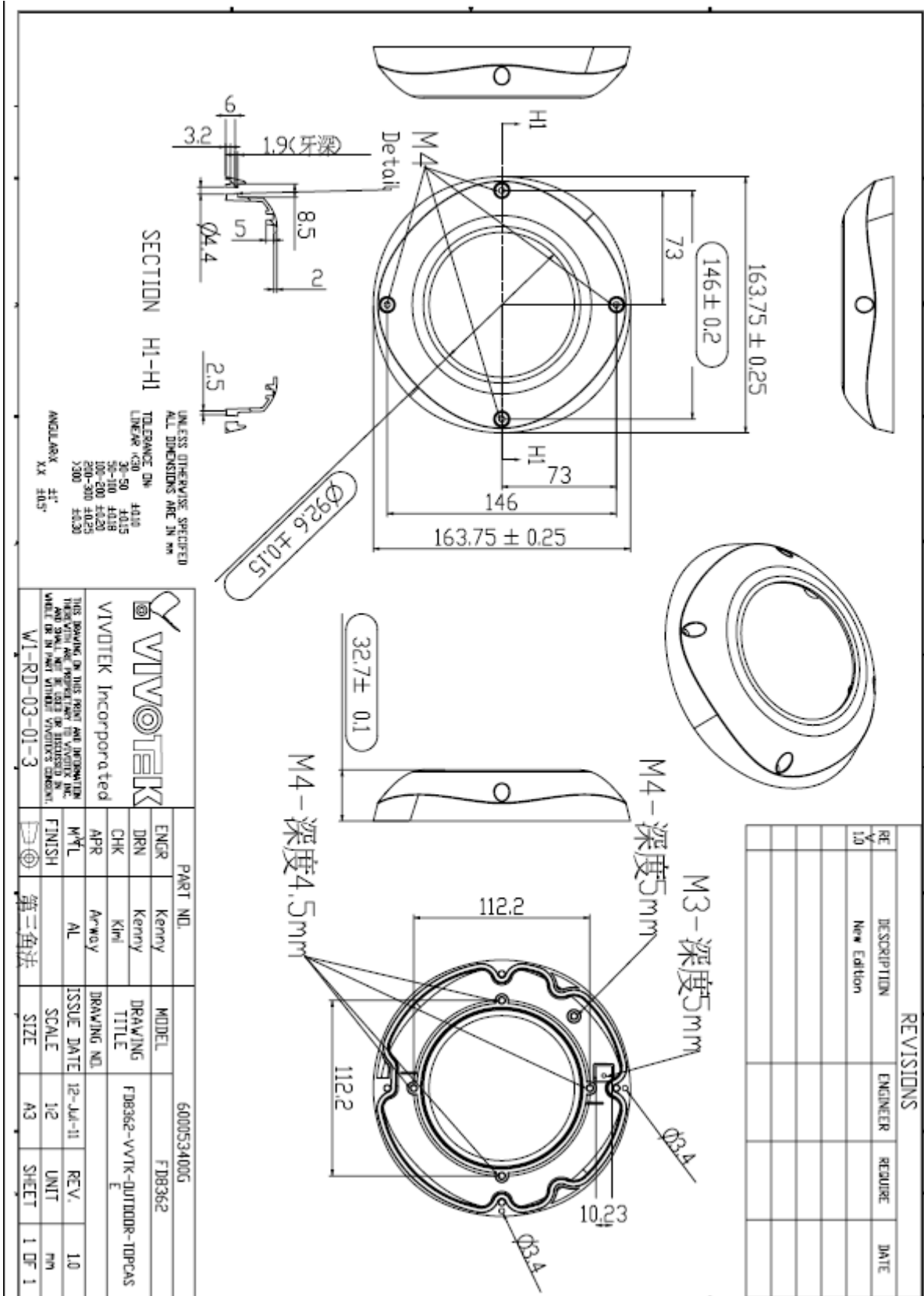



Diagrams ID 4-01

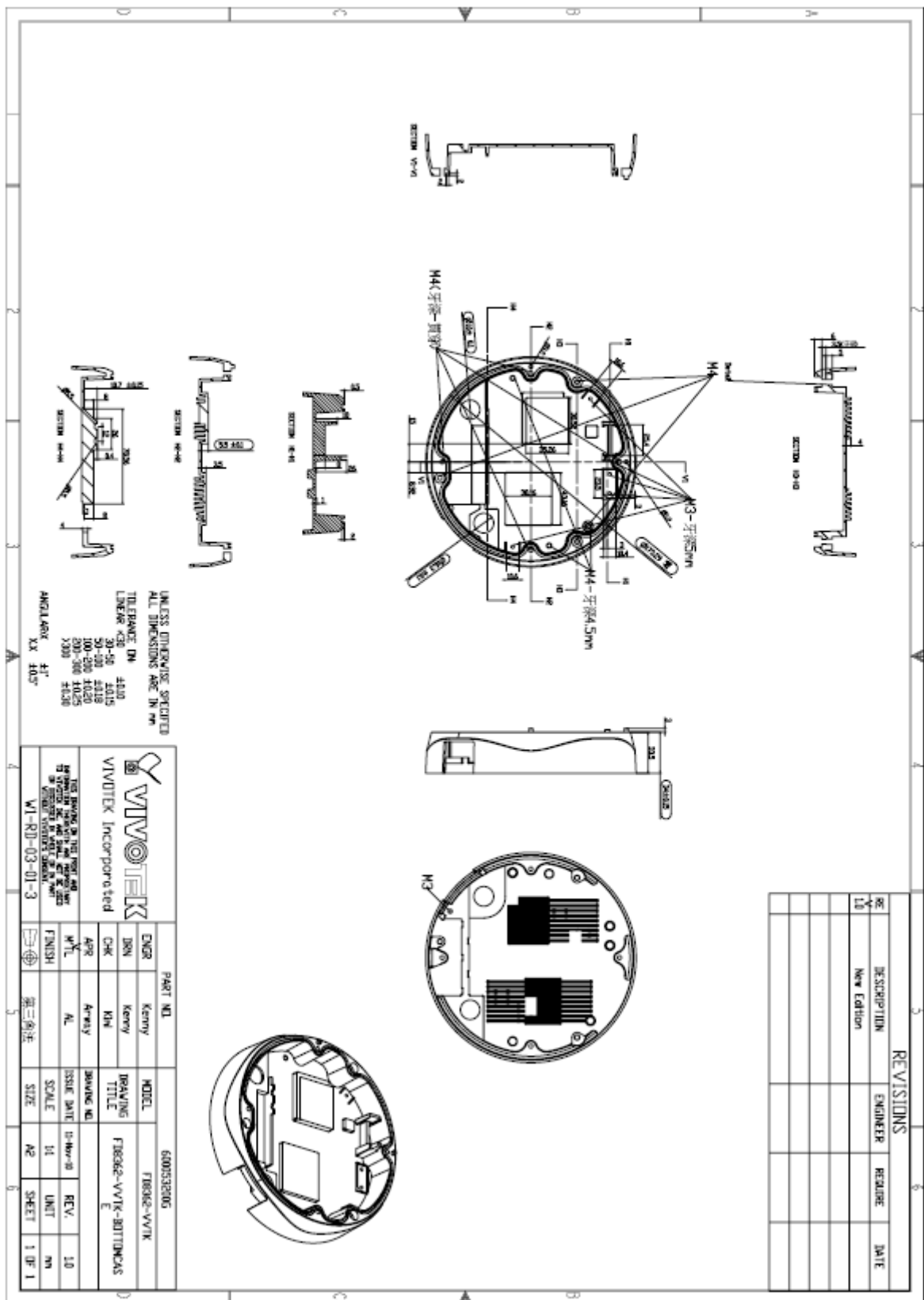



Diagrams ID 4-02

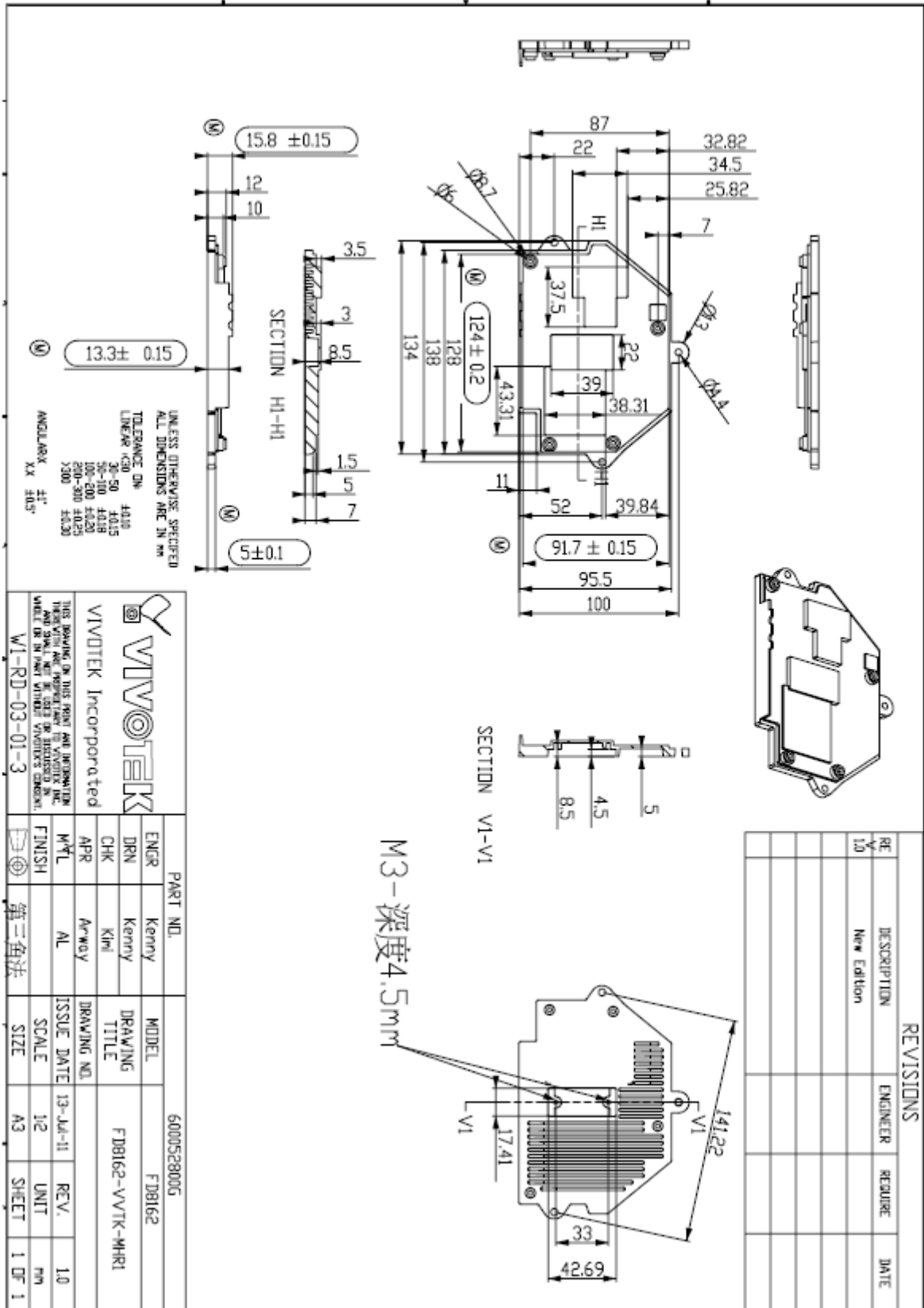



Diagrams ID 4-03

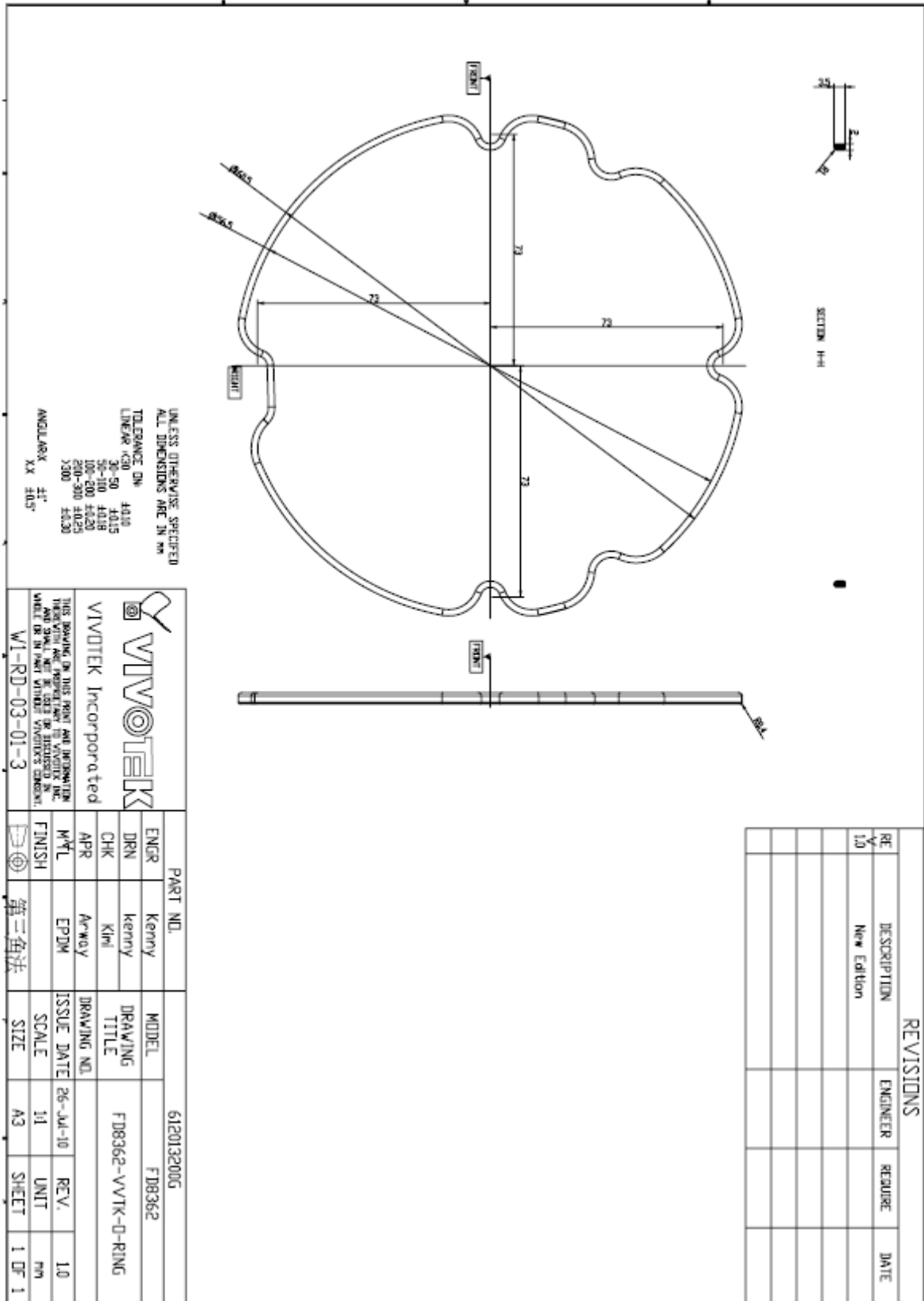



TEST REPORT

Report No.: HC30063A/2012
Page: 1 of 7
Date: April 2, 2012

VIVOTEK INC.
6F, NO. 192, LIEN-CHENG RD.,
CHUNG HO, NEW TAIPEI CITY,
TAIWAN, R.O.C.

The following merchandise was submitted and identified by the vendor as:
Product Description: Outdoor Dome Network Camera
Style/ Item No.: FD8335H/ No.1
Manufacturer/Vendor: Vivotek Inc.
Country of Origin: Taiwan
Quantity: Total 1 piece
Testing Period: Mar. 8, 2012 to Mar. 12, 2012

We have tested the submitted sample(s) as requested and the following results were obtained:
Test Required:

Test for Degrees of Protection Provided by Enclosures (IEC 60529 Edition 2.1:2001)

Table with 2 columns: IP Code, IP66. Rows include First characteristic numeral and Second characteristic numeral with descriptions of protection against hazardous parts, solid foreign objects, and water ingress.

Test Results:

Table with 1 column: Conclusion. Content: Submittals sample(s) comply with the requirement and acceptance conditions of IEC 60529 Edition 2.1:2001 Degrees of Protection Provided by Enclosures -- IP66. The detailed description of test result, please see attached sheet(s).

* HC30063/2012, dated March 14, 2012, is hereby canceled and replaced by HC30063A/2012.

Signed for and on behalf of
SGS TAIWAN Ltd.

Handwritten signature: Hank Chiou

Hank Chiou
Asst. Supervisor

Unless otherwise stated the results shown in this test report refer only to the sample(s) tested and such sample(s) are retained for 90 days only. This test report cannot be reproduced, except in full, without prior written permission of the Company. 除非另有說明，此報告結果僅對測試之樣品負責，同時此樣品僅保留90天。本報告未經本公司書面許可，不可部分複製。
This document is issued by the Company subject to its General Conditions of Service printed overleaf, available on request or accessible at www.sgs.com/terms_and_conditions.htm and, for electronic format documents, subject to Terms and Conditions for Electronic Documents at www.sgs.com/terms_e-document.htm. Attention is drawn to the limitation of liability, indemnification and jurisdiction issues defined therein. Any holder of this document is advised that information contained hereon reflects the Company's findings at the time of its intervention only and within the limits of Client's instructions, if any. The Company's sole responsibility is to its Client and this document does not exonerate parties to a transaction from exercising all their rights and obligations under the transaction documents. This document cannot be reproduced except in full, without prior written approval of the Company. Any unauthorized alteration, forgery or falsification of the content or appearance of this document is unlawful and offenders may be prosecuted to the fullest extent of the law.



TEST REPORT

Report No.: HC30063A/2012

Page: 2 of 7

Test for Degrees of Protection Provided by Enclosures:

Test Equipment:

Name	Brand	Model	Serial No.
1.0 mm Test Wire Probe	E.D.&D.	TRP-02	B0050180
Digital Force Gauge	ALGOL	HF-50	HF-106764
Dust Tester	T-MACHINE	TMJ-9723C	T-23-050411
IPX6 Water Jet Hose Nozzle Set	PTL	P03.28	5040045

Lab Environmental Conditions:

Ambient temperature: 25±3°C

Relative humidity: 55±20%RH

Test Method/ Specification:

Test method: IEC 60529 Edition 2.1:2001--IP66

1. Test for protection against access to hazardous parts:

Test method: IEC 60529 Edition 2.1:2001--IP6X

The test wire with 1.0 mm in diameter and 100 mm long is pushed against or inserted through any openings of the enclosure with the force specified in Table 6 in IEC 60529 Edition 2.1: 2001 Examine whether the test wire touches the hazardous live parts inside the enclosure or not.

Test force: 1 N±10 %

2. Test for protection against solid foreign objects:

Test method: IEC 60529 Edition 2.1:2001--IP6X (Dust test)

Type of dust: Talcum powder

The amount of dust: 2 kg

The chamber size: 1 m³

The maximum depression: -20 mbar

Test duration: 8 hours

- Examine the protection against ingress of dust of specimen(s) after this test.

Unless otherwise stated the results shown in this test report refer only to the sample(s) tested and such sample(s) are retained for 90 days only. This test report cannot be reproduced, except in full, without prior written permission of the Company. 除非另有說明，此報告結果僅對測試之樣品負責，同時此樣品僅保留90天。本報告未經本公司書面許可，不可部份複製。

This document is issued by the Company subject to its General Conditions of Service printed overleaf, available on request or accessible at www.sgs.com/terms_and_conditions.htm and, for electronic format documents, subject to Terms and Conditions for Electronic Documents at www.sgs.com/terms_e-document.htm. Attention is drawn to the limitation of liability, indemnification and jurisdiction issues defined therein. Any holder of this document is advised that information contained hereon reflects the Company's findings at the time of its intervention only and within the limits of Client's instructions, if any. The Company's sole responsibility is to its Client and this document does not exonerate parties to a transaction from exercising all their rights and obligations under the transaction documents. This document cannot be reproduced except in full, without prior written approval of the Company. Any unauthorized alteration, forgery or falsification of the content or appearance of this document is unlawful and offenders may be prosecuted to the fullest extent of the law.

SGS Taiwan Ltd.
台灣檢驗科技股份有限公司

No.31, No.33, No.35, Wu Chyuan Road, New Taipei Industrial Park, Wuku District, New Taipei City, Taiwan/新北市五股區新北大業園區五權路31號, 33號, 35號
No.134, Wu Kung Road, New Taipei Industrial Park, Wuku District, New Taipei City, Taiwan/新北市五股區新北大業園區五工路134號
t (886-2) 2299-3279 f (886-2) 2299-9558 www.tesgs.com
Member of SGS Group



SGS

Reliability Laboratory

TEST REPORT

Report No.: HC30063A/2012

Page: 3 of 7

Test Method/ Specification--Continued:

3. Test for protection against water:

Test method: IEC 60529 Edition 2.1:2001--IPX6

Test means: Spraying the enclosure from all practicable directions with a stream of water from a standard test nozzle as specified in test standard.

Internal diameter

of the nozzle: 12.5 mm

Delivery rate: 100 l/min +5%

Distance from nozzle

to enclosure surface: between 2.5 m and 3 m

Core of the substantial

stream: circle of approximately 120 mm diameter at 2.5 m distance from nozzle

Test duration: 3 minutes

- Examine the protection against ingress water of specimen(s) after this test.

Unless otherwise stated the results shown in this test report refer only to the sample(s) tested and such sample(s) are retained for 90 days only. This test report cannot be reproduced, except in full, without prior written permission of the Company. 除非另有說明，此報告結果僅對測試之樣品負責，同時此樣品僅保留90天。本報告未經本公司審閱許可，不可部份複製。
 This document is issued by the Company subject to its General Conditions of Service printed overleaf, available on request or accessible at www.sgs.com/terms_and_conditions.htm and, for electronic format documents, subject to Terms and Conditions for Electronic Documents at www.sgs.com/terms_e-document.htm. Attention is drawn to the limitation of liability, indemnification and jurisdiction issues defined therein. Any holder of this document is advised that information contained hereon reflects the Company's findings at the time of its intervention only and within the limits of Client's instructions, if any. The Company's sole responsibility is to its Client and this document does not exonerate parties to a transaction from exercising all their rights and obligations under the transaction documents. This document cannot be reproduced except in full, without prior written approval of the Company. Any unauthorized alteration, forgery or falsification of the content or appearance of this document is unlawful and offenders may be prosecuted to the fullest extent of the law.

SGS Taiwan Ltd.
 台灣檢驗科技股份有限公司

No.31, No.33, No.35, Wu Chyuan Road, New Taipei Industrial Park, Wuku District, New Taipei City, Taiwan/新北市五股區新北產業園區五權路31號, 33號, 35號
 No.134, Wu Kang Road, New Taipei Industrial Park, Wuku District, New Taipei City, Taiwan/新北市五股區新北產業園區五二路134號
 t (886-2) 2299-3279 f (886-2) 2299-9558 www.tw.sgs.com
 Member of SGS Group



TEST REPORT

Report No.: HC30063A/2012

Page: 4 of 7

Specimen:

Style/ Item No.: FD8335H/ No.1

Quantity: Total 1 piece

Test Result:

A. Degrees of protection against access to hazardous parts and against solid foreign objects (IP6X)

A-1 Test for protection against access to hazardous parts (IP6X)

Test Result		Style/ Item No.
Check Item		FD8335H/ No.1
1	Does the test wire penetrate any openings of the enclosure?	No
2	(followed check item 1) If the test wire penetrates any openings of the enclosure, does the test wire touch any hazardous live parts or any hazardous mechanical parts?	N/A
3	(followed check item 2) Does adequate clearance be kept between the test wire and hazardous live parts or hazardous mechanical parts?	N/A
Note 1: N/A means "Not Applicable".		
Note 2: The check items in this test report for inspecting the degree of protection provided by enclosures are reference to the requirements specified in IEC 60529 Edition 2.1:2001 and in accordance with the acceptance conditions specified by client.		

A-2 Test for protection against solid foreign objects (IP6X)

Test Result		Style/ Item No.
Check Item		FD8335H/ No.1
1	Does any dust deposit inside the enclosure?	No
Note 1: N/A means "Not Applicable".		
Note 2: The check items in this test report for inspecting the degree of protection provided by enclosures are reference to the requirements specified in IEC 60529 Edition 2.1:2001 and in accordance with the acceptance conditions specified by client.		

Unless otherwise stated the results shown in this test report refer only to the sample(s) tested and such sample(s) are retained for 90 days only. This test report cannot be reproduced, except in full, without prior written permission of the Company. 除非另有說明，此報告結果僅對測試之樣品負責，同時此樣品僅保留 90 天。本報告未經本公司書面許可，不可部份複製。

This document is issued by the Company subject to its General Conditions of Service printed overleaf, available on request or accessible at www.sgs.com/terms_and_conditions.htm and, for electronic format documents, subject to Terms and Conditions for Electronic Documents at www.sgs.com/terms_e-documents.htm. Attention is drawn to the limitation of liability, indemnification and jurisdiction issues defined therein. Any holder of this document is advised that information contained hereon reflects the Company's findings at the time of its intervention only and within the limits of Client's instructions, if any. The Company's sole responsibility is to its Client and this document does not exonerate parties to a transaction from exercising all their rights and obligations under the transaction documents. This document cannot be reproduced except in full, without prior written approval of the Company. Any unauthorized alteration, forgery or falsification of the content or appearance of this document is unlawful and offenders may be prosecuted to the fullest extent of the law.

SGS Taiwan Ltd. No.31, No.33, No.35, Wu Chyuan Road, New Taipei Industrial Park, WuKu District, New Taipei City, Taiwan/新北市五股區新北產業園區五權路 31 號, 33 號, 35 號
 台灣檢驗科技股份有限公司 No.134, Wu Kung Road, New Taipei Industrial Park, WuKu District, New Taipei City, Taiwan/新北市五股區新北產業園區五工路 134 號
 t (886-2) 2299-3279 f (886-2) 2299-9558 www.tsgs.com Member of SGS Group



Reliability Laboratory

TEST REPORT

Report No.: HC30063A/2012

Page: 5 of 7

Test Result--Continued:

B. Degree of protection against ingress of water (IPX6)

Test Result		Style/ Item No.
Check Item		FD8335H/ No.1
1	Does any water enter the enclosure?	No
2	(followed check item 1) If any water has entered, does the water accumulate near the cable end or live parts?	N/A
2.1	(followed check item 2) Does the water be sufficient to interfere with the correct operation of the equipment or impair safety?	N/A
2.2	(followed check item 2.1) Does the water deposit on insulation parts where it could lead to tracking along the creepage distances?	N/A
2.3	(followed check item 2.2) Does the water reach live parts or windings not designed to operate when wet?	N/A
Note 1: N/A means "Not Applicable".		
Note 2: The check items in this test report for inspecting the degree of protection provided by enclosures are reference to the requirements specified in IEC 60529 Edition 2.1:2001 and in accordance with the acceptance conditions specified by client.		

Unless otherwise stated the results shown in this test report refer only to the sample(s) tested and such sample(s) are retained for 90 days only. This test report cannot be reproduced, except in full, without prior written permission of the Company. 除非另有說明，此報告結果僅對所檢之樣品負責，同時此樣品僅保留 90 天。本報告未經本公司書面許可，不可部份複製。

This document is issued by the Company subject to its General Conditions of Service printed overleaf, available on request or accessible at www.sgs.com/terms_and_conditions.htm and, for electronic format documents, subject to Terms and Conditions for Electronic Documents at www.sgs.com/terms_e-document.htm. Attention is drawn to the limitation of liability, indemnification and jurisdiction issues defined therein. Any holder of this document is advised that information contained hereon reflects the Company's findings at the time of its intervention only and within the limits of Client's instructions, if any. The Company's sole responsibility is to its Client and this document does not exonerate parties to a transaction from exercising all their rights and obligations under the transaction documents. This document cannot be reproduced except in full, without prior written approval of the Company. Any unauthorized alteration, forgery or falsification of the content or appearance of this document is unlawful and offenders may be prosecuted to the fullest extent of the law.



TEST REPORT

Report No.: HC30063A/2012

Page: 6 of 7

Test Photos:

1. Appearance of specimen: FD8335H/ No.1	
2. Test for protection against access to hazardous parts	3. Test for protection against access to hazardous parts
4. Test for protection against solid foreign objects (Dust test)	5. Test for protection against solid foreign objects (Dust test)

Unless otherwise stated the results shown in this test report refer only to the sample(s) tested and such sample(s) are retained for 90 days only. This test report cannot be reproduced, except in full, without prior written permission of the Company. 除非另有說明，此報告結果僅對測試之樣品負責，同時此樣品僅保留 90 天。本報告未經本公司書面許可，不可部份複製。

This document is issued by the Company subject to its General Conditions of Service printed overleaf, available on request or accessible at www.sgs.com/terms_and_conditions.htm and, for electronic format documents, subject to Terms and Conditions for Electronic Documents at www.sgs.com/terms_e-document.htm. Attention is drawn to the limitation of liability, indemnification and jurisdiction issues defined therein. Any holder of this document is advised that information contained hereon reflects the Company's findings at the time of its intervention only and within the limits of Client's instructions, if any. The Company's sole responsibility is to its Client and this document does not exonerate parties to a transaction from exercising all their rights and obligations under the transaction documents. This document cannot be reproduced except in full, without prior written approval of the Company. Any unauthorized alteration, forgery or falsification of the content or appearance of this document is unlawful and offenders may be prosecuted to the fullest extent of the law.

SGS Taiwan Ltd. No.31, No.33, No.35, Wu Chuan Road, New Taipei Industrial Park, Wuku District, New Taipei City, Taiwan/新北市五股區新北大業園區五權路 31 號, 33 號, 35 號
 台灣檢驗科技股份有限公司 No.134, Wu Kung Road, New Taipei Industrial Park, Wuku District, New Taipei City, Taiwan/新北市五股區新北大業園區五工路 134 號
 t (886-2) 2299-3279 f (886-2) 2299-9558 www.tw.sgs.com
 Member of SGS Group



TEST REPORT

Report No.: HC30063A/2012

Page: 7 of 7

Test Photos--Continued:

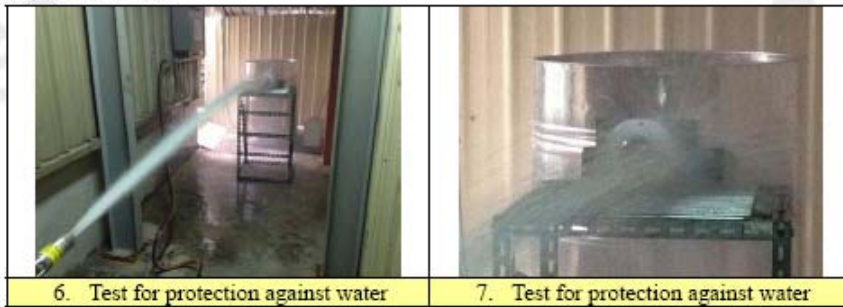

— — — The End of Test Report — — —

Unless otherwise stated the results shown in this test report refer only to the sample(s) tested and such sample(s) are retained for 90 days only. This test report cannot be reproduced, except in full, without prior written permission of the Company. 除非另有說明，此報告純專針對被試之樣品負責，同時此樣品僅保留 90 天。本報告未經本公司書面許可，不可部份複製。

This document is issued by the Company subject to its General Conditions of Service printed overleaf, available on request or accessible at www.sgs.com/terms_and_conditions.htm and, for electronic format documents, subject to Terms and Conditions for Electronic Documents at www.sgs.com/terms_e-document.htm. Attention is drawn to the limitation of liability, indemnification and jurisdiction issues defined therein. Any holder of this document is advised that information contained hereon reflects the Company's findings at the time of its intervention only and within the limits of Client's instructions, if any. The Company's sole responsibility is to its Client and this document does not exonerate parties to a transaction from exercising all their rights and obligations under the transaction documents. This document cannot be reproduced except in full, without prior written approval of the Company. Any unauthorized alteration, forgery or falsification of the content or appearance of this document is unlawful and offenders may be prosecuted to the fullest extent of the law.

SGS Taiwan Ltd. No.31, No.33, No.35, Wu Chyuan Road, New Taipei Industrial Park, Wuku District, New Taipei City, Taiwan/新北市五股區新北產業園區五權路 31 號, 33 號, 35 號
 No.134, Wu Kung Road, New Taipei Industrial Park, Wuku District, New Taipei City, Taiwan/新北市五股區新北產業園區五工路 134 號
 台灣檢驗科技股份有限公司 t (886-2) 2299-3279 f (886-2) 2299-9558 www.tsgs.com Member of SGS Group