



Test Report

Product Name : Network Camera

Model No. : FD8162, FD8162V

Applicant : VIVOTEK INC.

Address : 6F, No.192, Lien-Cheng Rd., Chung-Ho, New Taipei City,
235, Taiwan, R.O.C.

Date of Receipt : 2011/06/22

Issued Date : 2011/06/30

Report No. : 116363R-ITCEP11V04

Report Version : V1.0

The test results relate only to the samples tested.

The test results shown in the test report are traceable to the national/international standard through the calibration of the equipment and evaluated measurement uncertainty herein.

This report must not be used to claim product endorsement by TAF, NVLAP or any agency of the Government.

The test report shall not be reproduced except in full without the written approval of QuieTek Corporation.



Declaration of Conformity

We herewith confirm the following designated products to comply with the requirements set out in the Council Directive on the approximation of the laws of the Member States relating to Electromagnetic Compatibility Directive (2004/108/EC) with applicable standards listed below.

Product : Network Camera
Trade name : VIVOTEK
Model Number : FD8162, FD8162V
Applicable Harmonized : EN 55022: 2006+A1: 2007, Class B
Standards under Directive EN 55024: 1998+A1: 2001+A2: 2003
2004/108/EC EN 61000-3-2: 2006+A2: 2009, Class A
EN 61000-3-3: 2008

Company Name : _____
Company Address : _____
Telephone : _____ Facsimile : _____

Person in responsible for marking this declaration:

_____ Name (Full Name)	_____ Title/ Department
_____ Date	_____ Legal Signature



Statement of Conformity

This statement is to certify that the designated product below.

Product : Network Camera
Trade name : VIVOTEK
Model Number : FD8162, FD8162V
Company Name : VIVOTEK INC.
Applicable Standards : EN 55022: 2006+A1: 2007, Class B
EN 55024: 1998+A1: 2001+A2: 2003
EN 61000-3-2: 2006+A2: 2009, Class A
EN 61000-3-3: 2008

One sample of the designated product has been tested and evaluated in our laboratory to find in compliance with the applicable standards above. The issued test report(s) show(s) it in detail.

Report Number : 116363R-ITCEP11V04



Testing Laboratory

0914

TEST LABORATORY

Vincent Lin / Manager

The verification is based on a single evaluation of one sample of above-mentioned products. It does not imply an assessment of the whole production and does not permit the use of the test lab. Logo.

Test Report Certification

Issued Date : 2011/06/30
 Report No. : 116363R-ITCEP11V04



Product Name : Network Camera
 Applicant : VIVOTEK INC.
 Address : 6F, No.192, Lien-Cheng Rd., Chung-Ho, New Taipei City,
 235, Taiwan, R.O.C.
 Manufacturer : VIVOTEK INC.
 Model No. : FD8162, FD8162V
 EUT Rated Voltage : AC 24V, DC 12V, By POE
 EUT Test Voltage : AC 230 V / 50 Hz
 Trade Name : VIVOTEK
 Applicable Standard : EN 55022: 2006+A1: 2007, Class B
 EN 55024: 1998+A1: 2001+A2: 2003
 EN 61000-3-2:2006+A2: 2009
 EN 61000-3-3:2008
 AS/NZS CISPR 22: 2009
 Test Result : Complied
 Performed Location : Quietek Corporation (Linkou Laboratory)
 No. 5-22, Rueishu Keng, Linkou Dist., New Taipei City
 24451, Taiwan. R.O.C.
 TEL:+866-2-8601-3788 / FAX:+886-2-8601-3789

Documented By : Jinn Chen
 (Senior Adm. Specialist / Jinn Chen)

Reviewed By : Harrison chen
 (Engineer / Harrison Chen)

Approved By : [Signature]
 (Manager / Vincent Lin)

Laboratory Information

We , **Quietek Corporation**, are an independent EMC and safety consultancy that was established the whole facility in our laboratories. The test facility has been accredited/accepted (audited or listed) by the following related bodies in compliance with ISO 17025, EN 45001 and specified testing scopes:

Taiwan R.O.C.	:	BSMI, NCC, TAF
Germany	:	TUV Rheinland
Norway	:	Nemko, DNV
USA	:	FCC, NVLAP
Japan	:	VCCI

The related certificate for our laboratories about the test site and management system can be downloaded from Quietek Corporation's Web Site : <http://www.quietek.com/tw/ctg/cts/accreditations.htm>

The address and introduction of Quietek Corporation's laboratories can be founded in our Web site : <http://www.quietek.com/>

If you have any comments, Please don't hesitate to contact us. Our contact information is as below:

HsinChu Testing Laboratory :

No.75-2, 3rd Lin, Wangye Keng, Yonghxing Tsuen, Qionglin Shiang, Hsinchu County 307, Taiwan, R.O.C.
 TEL:+886-3-592-8858 / FAX:+886-3-592-8859 E-Mail : service@quietek.com



LinKou Testing Laboratory :

No. 5-22, Rueishu Keng, Linkou Dist., New Taipei City 24451, Taiwan. R.O.C.
 TEL : 886-2-8601-3788 / FAX : 886-2-8601-3789 E-Mail : service@quietek.com



Suzhou (China) Testing Laboratory :

No. 99 Hongye Rd., Suzhou Industrial Park Loufeng Hi-Tech Development Zone., Suzhou,China.
 TEL : +86-512-6251-5088 / FAX : +86-512-6251-5098 E-Mail : service@quietek.com



TABLE OF CONTENTS

Description	Page
1. General Information	7
1.1. EUT Description.....	7
1.2. Mode of Operation	8
1.3. Tested System Details	9
1.4. Configuration of Tested System	10
1.5. EUT Exercise Software.....	12
2. Technical Test	13
2.1. Summary of Test Result.....	13
2.2. List of Test Equipment	14
2.3. Measurement Uncertainty.....	17
2.4. Test Environment.....	19
3. Conducted Emission (Main Terminals).....	20
3.1. Test Specification	20
3.2. Test Setup.....	20
3.3. Limit	20
3.4. Test Procedure	21
3.5. Deviation from Test Standard.....	21
3.6. Test Result	22
3.7. Test Photograph	34
4. Conducted Emissions (Telecommunication Ports).....	36
4.1. Test Specification	36
4.2. Test Setup.....	36
4.3. Limit	36
4.4. Test Procedure	37
4.5. Deviation from Test Standard.....	37
4.6. Test Result	38
4.7. Test Photograph	56
5. Radiated Emission	59
5.1. Test Specification	59
5.2. Test Setup.....	59
5.3. Limit	60
5.4. Test Procedure	61
5.5. Deviation from Test Standard.....	61
5.6. Test Result.....	62
5.7. Test Photograph	74
6. Harmonic Current Emission	79

6.1.	Test Specification	79
6.2.	Test Setup.....	79
6.3.	Limit.....	79
6.4.	Test Procedure	81
6.5.	Deviation from Test Standard.....	81
6.6.	Test Result.....	82
6.7.	Test Photograph	86
7.	Voltage Fluctuation and Flicker.....	87
7.1.	Test Specification.....	87
7.2.	Test Setup.....	87
7.3.	Limit.....	87
7.4.	Test Procedure	88
7.5.	Deviation from Test Standard.....	88
7.6.	Test Result.....	89
7.7.	Test Photograph	91
8.	Electrostatic Discharge	92
8.1.	Test Specification.....	92
8.2.	Test Setup.....	92
8.3.	Limit.....	92
8.4.	Test Procedure	93
8.5.	Deviation from Test Standard.....	93
8.6.	Test Result.....	94
8.7.	Test Photograph	97
9.	Radiated Susceptibility	99
9.1.	Test Specification.....	99
9.2.	Test Setup.....	99
9.3.	Limit.....	99
9.4.	Test Procedure	100
9.5.	Deviation from Test Standard.....	100
9.6.	Test Result.....	101
9.7.	Test Photograph	104
10.	Electrical Fast Transient/Burst.....	106
10.1.	Test Specification.....	106
10.2.	Test Setup.....	106
10.3.	Limit.....	106
10.4.	Test Procedure	107
10.5.	Deviation from Test Standard.....	107
10.6.	Test Result.....	108

10.7.	Test Photograph	111
11.	Surge	114
11.1.	Test Specification	114
11.2.	Test Setup.....	114
11.3.	Limit.....	114
11.4.	Test Procedure	115
11.5.	Deviation from Test Standard.....	115
11.6.	Test Result.....	116
11.7.	Test Photograph	118
12.	Conducted Susceptibility	119
12.1.	Test Specification	119
12.2.	Test Setup.....	119
12.3.	Limit.....	120
12.4.	Test Procedure	120
12.5.	Deviation from Test Standard.....	120
12.6.	Test Result.....	121
12.7.	Test Photograph	124
13.	Power Frequency Magnetic Field	127
13.1.	Test Specification	127
13.2.	Test Setup.....	127
13.3.	Limit.....	127
13.4.	Test Procedure	127
13.5.	Deviation from Test Standard.....	127
13.6.	Test Result.....	128
13.7.	Test Photograph	131
14.	Voltage Dips and Interruption.....	133
14.1.	Test Specification	133
14.2.	Test Setup.....	133
14.3.	Limit.....	133
14.4.	Test Procedure	134
14.5.	Deviation from Test Standard.....	134
14.6.	Test Result.....	135
14.7.	Test Photograph	137
15.	Attachment	138
	EUT Photograph.....	138

1. General Information

1.1. EUT Description

Product Name	Network Camera
Trade Name	VIVOTEK
Model No.	FD8162, FD8162V

Component	
Power Adapter (1)	MFR: ENG, M/N: 3A-183WP12 Input: 100-240VAC, 50-60Hz, 0.6A Output: 12VDC, 1.5A Cable Out: Non-Shielded, 1.8m
Power Adapter (2) (Optional)	MFR: TDC Power, M/N: DE-60-24W Input: 230VAC, 50Hz, 70VA Output: 24VAC, Max 60VA Cable IN: Non-Shielded, 1.8m Cable Out: Non-Shielded, 1.8m

Note:

- 1.The EUT is including two models.
- 2.The different of the each model is shown as below:

	FD8162V	FD8162
Lens	manual focus	manual focus
Heater	No	No
IR Led	Yes (20M)	Yes (20M)
Housing	Indoor	Indoor
	Vandal (Metal shell)	(Plastic shell)
Temperature	0~50	0~50
Internal material	Business Planning	Business Planning
Built-in MIC&PIR*	No	Yes

1.2. Mode of Operation

Quietek has verified the construction and function in typical operation. All the test modes were carried out with the EUT in normal operation, which was shown in this test report and defined as:

Pre-Test Mode	
Mode 1: Normal Operation, Adapter : 3A-183WP12	
Mode 2: Normal Operation, Adapter : DE-60-24W	
Mode 3: Normal Operation, PoE	
Final Test Mode	
Emission	Mode 1: Normal Operation, Adapter : 3A-183WP12 Mode 2: Normal Operation, Adapter : DE-60-24W Mode 3: Normal Operation, PoE
Immunity	Mode 1: Normal Operation, Adapter : 3A-183WP12 Mode 2: Normal Operation, Adapter : DE-60-24W Mode 3: Normal Operation, PoE

1.3. Tested System Details

The types for all equipments, plus descriptions of all cables used in the tested system (including inserted cards) ssare:

Test Mode		Mode 1: Normal Operation, Adapter : 3A-183WP12 Mode 2: Normal Operation, Adapter : DE-60-24W			
Product		Manufacturer	Model No.	Serial No.	Power Cord
1	Micro SD Card 1GB	SanDisk	N/A	0801002841D2N	N/A
2	Microphone & Earphone	Ergotech	ET-E201	N/A	N/A
3	Notebook PC	DELL	PP04X	2D2ZM1S	Non-Shielded, 0.8m

Test Mode		Mode 3: Normal Operation, PoE			
Product		Manufacturer	Model No.	Serial No.	Power Cord
1	Micro SD Card 1GB	SanDisk	N/A	0801002841D2N	N/A
2	Microphone & Earphone	Ergotech	ET-E201	N/A	N/A
3	PoE Adapter	LINKSYS	WAPPoE12	N/A	Non-Shielded, 1.8m
4	Notebook PC	DELL	PP04X	2D2ZM1S	Non-Shielded, 0.8m

1.4. Configuration of Tested System

Test Mode		Mode 1: Normal Operation, Adapter : 3A-183WP12 Mode 2: Normal Operation, Adapter : DE-60-24W
Connection Diagram		
<p>The diagram shows a dashed rectangular boundary enclosing the EUT (Under Test) and Micro SD Card (1). A vertical line labeled 'B' connects the EUT to a box labeled 'Microphone & Earphone (2)'. A horizontal line labeled 'A' connects the EUT to a box labeled 'Notebook PC (3)' located outside the dashed boundary.</p>		
Signal Cable Type		Signal cable Description
A	LAN Cable	Non-Shielded, 3m
B	Microphone & Earphone Cable	Non-Shielded, 2m

Test Mode	Mode 3: Normal Operation, PoE
-----------	-------------------------------

Connection Diagram

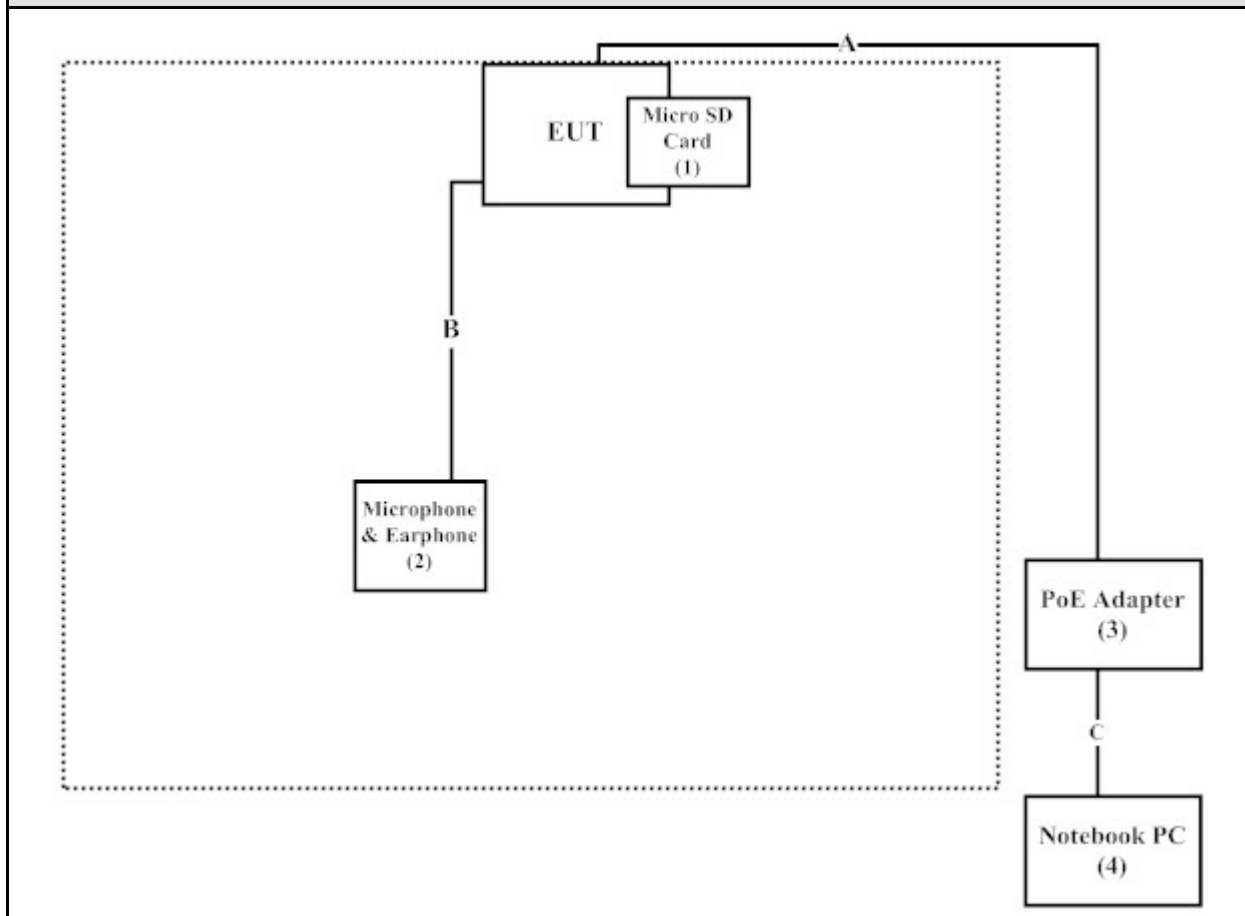

Signal Cable Type	Signal cable Description	
A	LAN Cable	Non-Shielded, 3m
B	Microphone & Earphone Cable	Non-Shielded, 2m
C	LAN Cable	Non-Shielded, 0.3m

1.5. EUT Exercise Software

1	Setup the EUT and simulators as shown on 1.4.
2	Turn on the power of all equipment.
3	The EUT will start to operate and display the video figure from the signal source.
4	The EUT will display “video figure” on monitor.
5	Repeat the above procedure (3) to (4).

2. Technical Test

2.1. Summary of Test Result

- No deviations from the test standards
 Deviations from the test standards as below description:

Emission			
Performed Item	Normative References	Test Performed	Deviation
Conducted Emission	EN 55022: 2006+A1: 2007 AS/NZS CISPR 22: 2009	Yes	No
Impedance Stabilization Network	EN 55022: 2006+A1: 2007 AS/NZS CISPR 22: 2009	Yes	No
Radiated Emission	EN 55022: 2006+A1: 2007 AS/NZS CISPR 22: 2009	Yes	No
Power Harmonics	EN 61000-3-2:2006+A2: 2009	Yes	No
Voltage Fluctuation and Flicker	EN 61000-3-3:2008	Yes	No

Immunity			
Performed Item	Normative References	Test Performed	Deviation
Electrostatic Discharge	IEC 61000-4-2: 2008	Yes	No
Radiated susceptibility	IEC 61000-4-3: 2010	Yes	No
Electrical fast transient/burst	IEC 61000-4-4: 2011	Yes	No
Surge	IEC 61000-4-5: 2005	Yes	No
Conducted susceptibility	IEC 61000-4-6: 2008	Yes	No
Power frequency magnetic field	IEC 61000-4-8: 2009	Yes	No
Voltage dips and interruption	IEC 61000-4-11: 2004	Yes	No

2.2. List of Test Equipment

Conducted Emission / SR1

Instrument	Manufacturer	Type No.	Serial No	Cal. Date
EMI Test Receiver	R&S	ESCS 30	100366	2010/11/10
LISN	R&S	ENV4200	833209/007	2010/09/06
LISN	R&S	ENV216	100085	2011/02/10
Pulse Limiter	R&S	ESH3-Z2	357.88.10.52	2010/09/02

Impedance Stabilization Network / SR1

Instrument	Manufacturer	Type No.	Serial No	Cal. Date
Capacitive Voltage Probe	Schaffner	CVP2200A	18331	2010/11/15
EMI Test Receiver	R&S	ESCS 30	100366	2010/11/10
LISN	R&S	ENV216	100085	2011/02/10
LISN	R&S	ENV4200	833209/007	2010/09/06
Pulse Limiter	R&S	ESH3-Z2	357.88.10.52	2010/09/02
RF Current Probe	FCC	F-65 10KHz~1GHz	198	2010/11/08
BALANCED TELECOM ISN	FCC	FCC-TLISN-T2-02	20316	2011/06/26
BALANCED TELECOM ISN	FCC	FCC-TLISN-T4-02	20317	2011/06/26
BALANCED TELECOM ISN	FCC	FCC-TLISN-T8-02	20319	2011/06/26

Radiated Emission / Site1

Instrument	Manufacturer	Type No.	Serial No	Cal. Date
Bilog Antenna	Schaffner Chase	CBL6112B	2918	2011/01/24
Broadband Horn Antenna	Schwarzbeck	BBHA9170	209	2010/10/27
EMI Test Receiver	R&S	ESCS 30	100121	2010/12/06
Horn Antenna	Schwarzbeck	BBHA9120D	305	2010/10/28
Pre-Amplifier	QTK	N/A	N/A	2010/08/01
Spectrum Analyzer	Advantest	R3162	100803482	2010/11/10

Radiated Emission / 9x6x6 Chamber

Instrument	Manufacturer	Type No.	Serial No	Cal. Date
EMI Test Receiver	R&S	ESIB26	838786/004	2010/07/05
Horn Antenna	Schwarzbeck	9120D	576	2010/11/12
Pre-Amplifier	Quietek	AP-180C	CHM/071920	2010/08/04

Power Harmonics / SR3

Instrument	Manufacturer	Type No.	Serial No	Cal. Date
AC Power Source(Harmonic)	Schaffner	NSG 1007	HK54148	2010/09/06
IEC1000-4-X Analyzer(Flicker)	Schaffner	CCN 1000-1	X7 1887	2010/09/06

Voltage Fluctuation and Flicker / SR3

Instrument	Manufacturer	Type No.	Serial No	Cal. Date
AC Power Source(Harmonic)	Schaffner	NSG 1007	HK54148	2010/09/06
IEC1000-4-X Analyzer(Flicker)	Schaffner	CCN 1000-1	X7 1887	2010/09/06

Electrostatic Discharge / SR6

Instrument	Manufacturer	Type No.	Serial No	Cal. Date
ESD Simulator System	Noiseken	TC-815R	ESS0929097	2010/08/30
Horizontal Coupling Plane(HCP)	Quietek	HCP AL50	N/A	N/A
Vertical Coupling Plane(VCP)	Quietek	VCP AL50	N/A	N/A

Radiated susceptibility / CB5

Instrument	Manufacturer	Type No.	Serial No	Cal. Date
AF-BOX	R&S	AF-BOX ACCUST	100007	N/A
Audio Analyzer	R&S	UPL 16	100137	2011/05/09
Biconilog Antenna	EMCO	3149	00071675	N/A
Directional Coupler	A&R	DC 6180	22735	N/A
Dual Microphone Supply	B&K	5935	2426784	2011/04/21
Mouth Simulator	B&K	4227	2439692	2011/04/21
Power Amplifier	A&R	30S1G3	309453	N/A
Power Amplifier	A&R	100W10000M7	A285000010	N/A
Power Amplifier	SCHAFFNER	CBA9413B	4020	N/A
Power Amplifier	AR	75A250A	0325371	N/A
Power Meter	R&S	NRVD(P.M)	100219	2011/05/09
Pre-Amplifier	A&R	150A220	23067	N/A
Probe Microphone	B&K	4182	2278070	2011/04/21
Signal Generator	R&S	SMT03	100170	2011/05/09

Electrical fast transient/burst / SR6

Instrument	Manufacturer	Type No.	Serial No	Cal. Date
Schaffner NSG 2050 System Mainframe	Schaffner	N/A	N/A	2011/06/08

Surge / SR6

Instrument	Manufacturer	Type No.	Serial No	Cal. Date
Schaffner NSG 2050 System Mainframe	Schaffner	N/A	N/A	2011/06/08

Conducted susceptibility / SR6

Instrument	Manufacturer	Type No.	Serial No	Cal. Date
Schaffner NSG 2070 RF-Generator	Schaffner	N/A	N/A	2011/04/07

Power frequency magnetic field / SR3

Instrument	Manufacturer	Type No.	Serial No	Cal. Date
Induction Coil Interface	Schaffner	INA 2141	6002	N/A
Magnetic Loop Coil	Schaffner	INA 702	160	N/A

Voltage dips and interruption / SR6

Instrument	Manufacturer	Type No.	Serial No	Cal. Date
Schaffner NSG 2050 System Mainframe	Schaffner	N/A	N/A	2011/06/08

Schaffner NSG 2050 System Mainframe				
Instrument	Manufacturer	Type No.	Serial No	Cal. Date
Burst 4.8KV/16A Generator with CDN	Schaffner	PNW2225	200123-098SC	2011/06/08
Damped osc. Wave 100kHz and 1MHz	Schaffner	PNW2056	200124-058SC	2011/06/08
Double AC Source Variator	Schaffner	NSG 642A	30910014938	2011/06/08
Hybrid surge pulse 1.2/50uS	Schaffner	PNW 2050	200532-514LU	2011/06/08
PQT Generator	Schaffner	PNW2003	200138-007SC	2011/06/08
Pulse COUPLING NETWORK	Schaffner	CDN131	200124-007SC	2011/06/08

Schaffner NSG 2070 RF-Generator				
Instrument	Manufacturer	Type No.	Serial No	Cal. Date
CDN	Schaffner	CAL U100A	20405	N/A
CDN	Schaffner	TRA U150	20454	N/A
CDN M016S	Schaffner	CAL U100A	20410	N/A
CDN M016S	Schaffner	TRA U150	21167	N/A
CDN T002	Schaffner	CAL U100	20491	N/A
CDN T002	Schaffner	TRA U150	21169	N/A
CDN T400	Schaffner	CAL U100	17735	N/A
CDN T400	Schaffner	TRA U150	21166	N/A
Coupling Decoupling Network	Schaffner	CDN M016S	20823	2011/04/08
Coupling Decoupling Network	Schaffner	CDN T002	19018	2011/04/08
Coupling Decoupling Network	Schaffner	CDN T400	21226	2011/04/08
EM-CLAMP	Schaffner	KEMZ 801	21024	2011/04/08

2.3. Measurement Uncertainty

Conducted Emission

The measurement uncertainty is evaluated as ± 2.26 dB.

Impedance Stabilization Network

The measurement uncertainty is evaluated as ± 2.26 dB.

Radiated Emission

The measurement uncertainty is evaluated as ± 3.19 dB.

Electrostatic Discharge

As what is concluded in the document from Note2 of clause 5.4.6.2 of ISO/IEC 17025: 1999[2], the requirements for measurement uncertainty in ESD testing are deemed to have been satisfied, and the testing is reported in accordance with the relevant ESD standards. The immunity test signal from the ESD system meet the required specifications in IEC 61000-4-2 through the calibration report with the calibrated uncertainty for the waveform of voltage and timing as being 3.0 % and 3.8%.

Radiated susceptibility

As what is concluded in the document from Note2 of clause 5.4.6.2 of ISO/IEC 17025: 1999[2], the requirements for measurement uncertainty in RS testing are deemed to have been satisfied, and the testing is reported in accordance with the relevant RS standards. The immunity test signal from the RS system meet the required specifications in IEC 61000-4-3 through the calibration for the uniform field strength and monitoring for the test level with the uncertainty evaluation report for the electrical field strength as being 3.57 dB.

Electrical fast transient/burst

As what is concluded in the document from Note2 of clause 5.4.6.2 of ISO/IEC 17025: 1999[2], the requirements for measurement uncertainty in EFT/Burst testing are deemed to have been satisfied, and the testing is reported in accordance with the relevant EFT/Burst standards. The immunity test signal from the EFT/Burst system meet the required specifications in IEC 61000-4-4 through the calibration report with the calibrated uncertainty for the waveform of voltage, frequency and timing as being 4 %, and 2.5%.

Surge

As what is concluded in the document from Note2 of clause 5.4.6.2 of ISO/IEC 17025: 1999[2], the requirements for measurement uncertainty in Surge testing are deemed to have been satisfied, and the testing is reported in accordance with the relevant Surge standards. The immunity test signal from the Surge system meet the required specifications in IEC 61000-4-5 through the calibration report with the calibrated uncertainty for the waveform of voltage and timing as being 3.5 % and 0.1%.

Conducted susceptibility

As what is concluded in the document from Note2 of clause 5.4.6.2 of ISO/IEC 17025: 1999[2], the requirements for measurement uncertainty in CS testing are deemed to have been satisfied, and the testing is reported in accordance with the relevant CS standards. The immunity test signal from the CS system meet the required specifications in IEC 61000-4-6 through the calibration for unmodulated signal and monitoring for the test level with the uncertainty evaluation report for the injected modulated signal level through CDN and EM Clamp/Direct Injection as being 2.0 dB and 2.61 dB.

Power frequency magnetic field

As what is concluded in the document from Note2 of clause 5.4.6.2 of ISO/IEC 17025: 1999[2], the requirements for measurement uncertainty in PFM testing are deemed to have been satisfied, and the testing is reported in accordance with the relevant PFM standards. The immunity test signal from the PFM system meet the required specifications in IEC 61000-4-8 through the calibration report with the calibrated uncertainty for the Gauss Meter to verify the output level of magnetic field strength as being 2.0 %.

Voltage dips and interruption

As what is concluded in the document from Note2 of clause 5.4.6.2 of ISO/IEC 17025: 1999[2], the requirements for measurement uncertainty in DIP testing are deemed to have been satisfied, and the testing is reported in accordance with the relevant DIP standards. The immunity test signal from the DIP system meet the required specifications in IEC 61000-4-11 through the calibration report with the calibrated uncertainty for the waveform of voltage and timing as being 3.5 % and 0.1%.

2.4. Test Environment

Performed Item	Items	Required	Actual
Conducted Emission	Temperature (°C)	15-35	25
	Humidity (%RH)	25-75	50
	Barometric pressure (mbar)	860-1060	950-1000
Impedance Stabilization Network	Temperature (°C)	15-35	25
	Humidity (%RH)	25-75	50
	Barometric pressure (mbar)	860-1060	950-1000
Radiated Emission	Temperature (°C)	15-35	25
	Humidity (%RH)	25-75	50
	Barometric pressure (mbar)	860-1060	950-1000
Electrostatic Discharge	Temperature (°C)	15-35	21
	Humidity (%RH)	30-60	51
	Barometric pressure (mbar)	860-1060	950-1000
Radiated susceptibility	Temperature (°C)	15-35	21
	Humidity (%RH)	25-75	51
	Barometric pressure (mbar)	860-1060	950-1000
Electrical fast transient/burst	Temperature (°C)	15-35	21
	Humidity (%RH)	25-75	51
	Barometric pressure (mbar)	860-1060	950-1000
Surge	Temperature (°C)	15-35	21
	Humidity (%RH)	10-75	51
	Barometric pressure (mbar)	860-1060	950-1000
Conducted susceptibility	Temperature (°C)	15-35	21
	Humidity (%RH)	25-75	51
	Barometric pressure (mbar)	860-1060	950-1000
Power frequency magnetic field	Temperature (°C)	15-35	21
	Humidity (%RH)	25-75	51
	Barometric pressure (mbar)	860-1060	950-1000
Voltage dips and interruption	Temperature (°C)	15-35	21
	Humidity (%RH)	25-75	51
	Barometric pressure (mbar)	860-1060	950-1000

3. Conducted Emission (Main Terminals)

3.1. Test Specification

According to EMC Standard : EN 55022

3.2. Test Setup

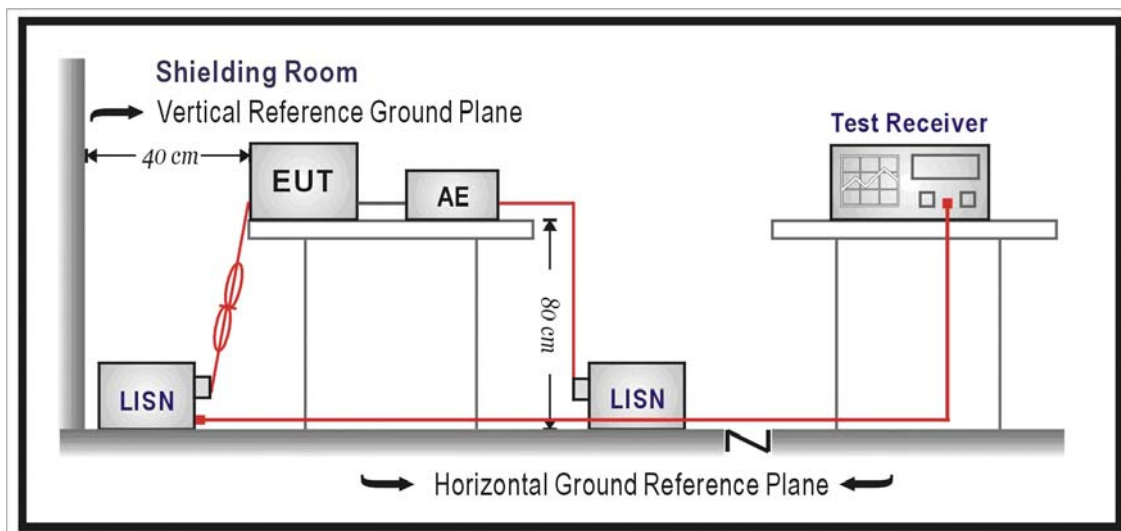

3.3. Limit

Limits		
Frequency (MHz)	QP (dBuV)	AV (dBuV)
0.15 - 0.50	66 - 56	56 - 46
0.50-5.0	56	46
5.0 - 30	60	50

Remarks: In the above table, the tighter limit applies at the band edges.

3.4. Test Procedure

The EUT and simulators are connected to the main power through a line impedance stabilization network (L.I.S.N.). This provides a 50 ohm /50uH coupling impedance for the measuring equipment. The peripheral devices are also connected to the main power through a LISN that provides a 50ohm/50uH coupling impedance with 50ohm termination.

(Please refers to the block diagram of the test setup and photographs.)

Both sides of A.C. line are checked for maximum conducted interference. In order to find the maximum emission, the relative positions of equipment and all of the interface cables must be changed on conducted measurement.

Conducted emissions were invested over the frequency range from 0.15MHz to 30MHz using a receiver bandwidth of 9kHz.

3.5. Deviation from Test Standard

No deviation.

3.6. Test Result

Site : SR_1	Time : 2011/06/17 - 17:29
Limit : CISPR_B_00M_QP	Margin : 10
EUT : Network Camera	Probe : ENV_216_L1 - Line1
Power : AC 230V/50Hz to DC 12V	Note : Mode 1

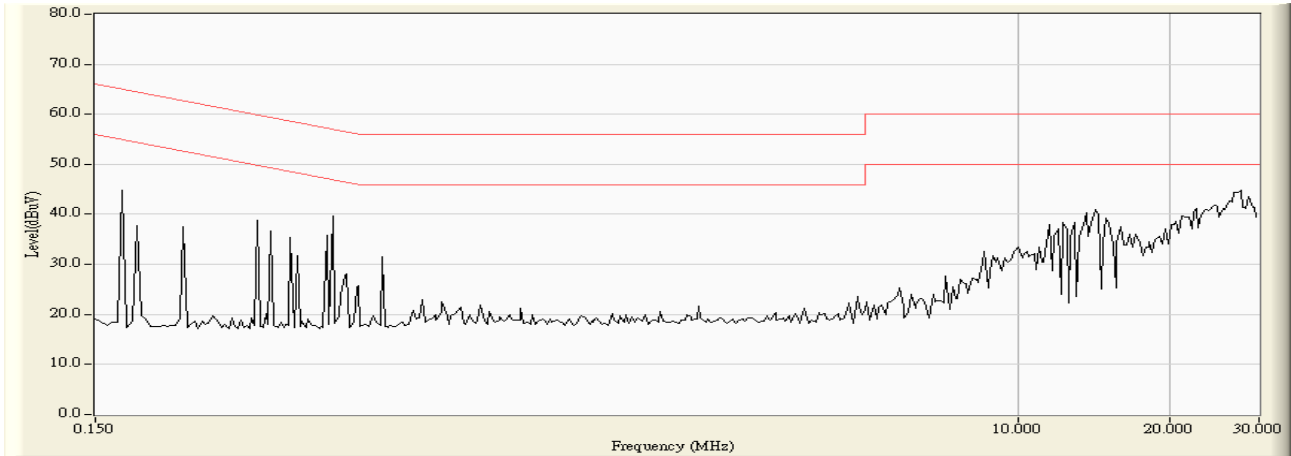

Site : SR_1	Time : 2011/06/17 - 17:33
Limit : CISPR_B_00M_QP	Margin : 0
EUT : Network Camera	Probe : ENV_216_L1 - Line1
Power : AC 230V/50Hz to DC 12V	Note : Mode 1

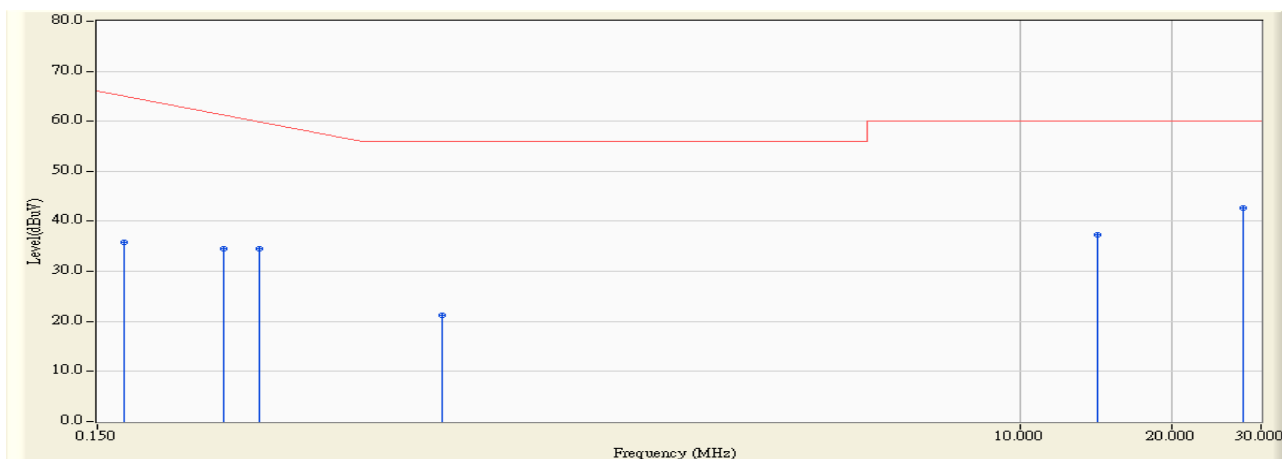

		Frequency (MHz)	Correct Factor (dB)	Reading Level (dBuV)	Measure Level (dBuV)	Margin (dB)	Limit (dBuV)	Detector Type
1		0.170	9.790	25.950	35.740	-29.689	65.429	QUASIPeAK
2		0.267	9.790	24.830	34.620	-28.037	62.657	QUASIPeAK
3		0.314	9.790	24.650	34.440	-26.874	61.314	QUASIPeAK
4		0.722	9.797	11.470	21.267	-34.733	56.000	QUASIPeAK
5		14.220	10.110	27.230	37.340	-22.660	60.000	QUASIPeAK
6	*	27.696	10.130	32.570	42.700	-17.300	60.000	QUASIPeAK

Note:

1. All Reading Levels are Quasi-Peak and average value.
2. " * ", means this data is the worst emission level.
3. Measurement Level = Reading Level + Correct Factor

Site : SR_1	Time : 2011/06/17 - 17:33
Limit : CISPR_B_00M_AV	Margin : 0
EUT : Network Camera	Probe : ENV_216_L1 - Line1
Power : AC 230V/50Hz to DC 12V	Note : Mode 1

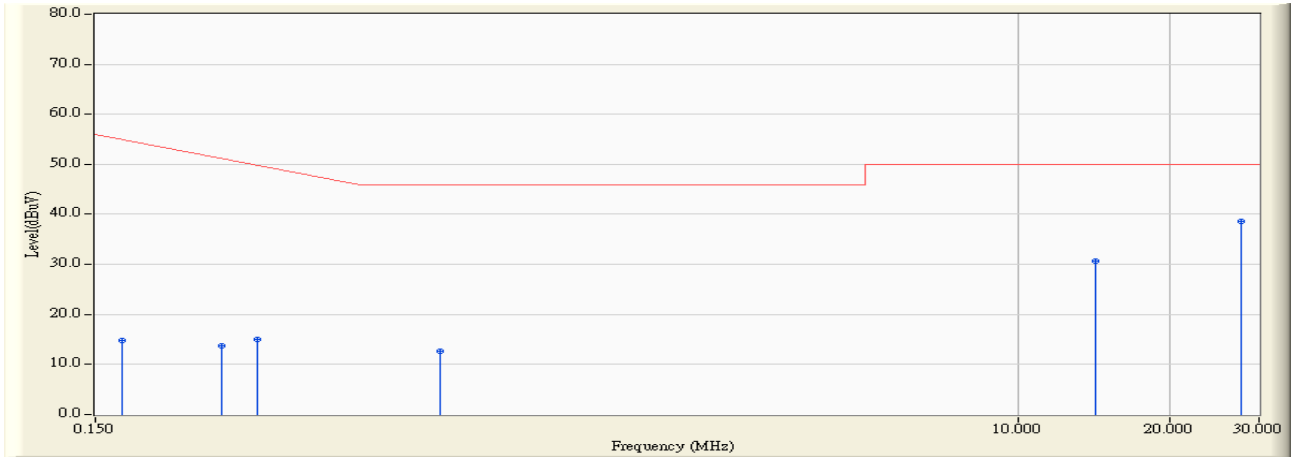

		Frequency (MHz)	Correct Factor (dB)	Reading Level (dBuV)	Measure Level (dBuV)	Margin (dB)	Limit (dBuV)	Detector Type
1		0.170	9.790	4.930	14.720	-40.709	55.429	AVERAGE
2		0.267	9.790	3.880	13.670	-38.987	52.657	AVERAGE
3		0.314	9.790	5.140	14.930	-36.384	51.314	AVERAGE
4		0.722	9.797	2.860	12.657	-33.343	46.000	AVERAGE
5		14.220	10.110	20.660	30.770	-19.230	50.000	AVERAGE
6	*	27.696	10.130	28.410	38.540	-11.460	50.000	AVERAGE

Note:

1. All Reading Levels are Quasi-Peak and average value.
2. " * ", means this data is the worst emission level.
3. Measurement Level = Reading Level + Correct Factor

Site : SR_1	Time : 2011/06/17 - 17:35
Limit : CISPR_B_00M_QP	Margin : 10
EUT : Network Camera	Probe : ENV_216_N - Line2
Power : AC 230V/50Hz to DC 12V	Note : Mode 1

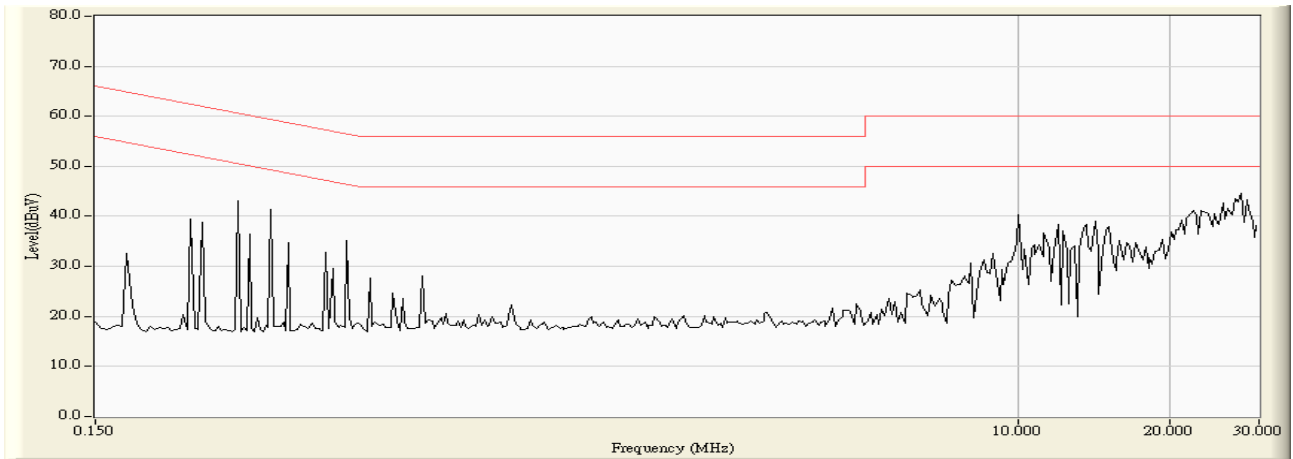

Site : SR_1	Time : 2011/06/17 - 17:36
Limit : CISPR_B_00M_QP	Margin : 0
EUT : Network Camera	Probe : ENV_216_N - Line2
Power : AC 230V/50Hz to DC 12V	Note : Mode 1

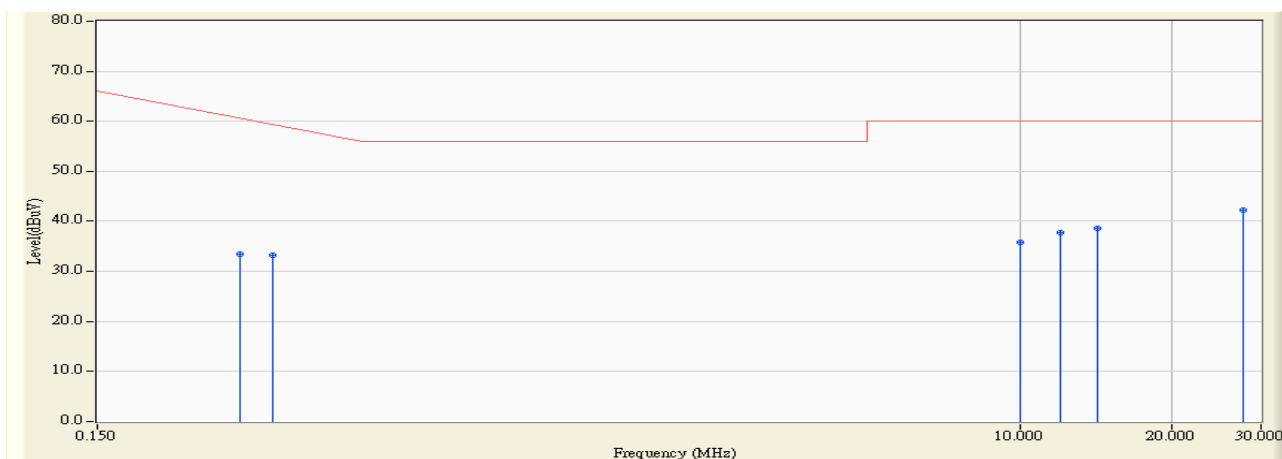

		Frequency (MHz)	Correct Factor (dB)	Reading Level (dBuV)	Measure Level (dBuV)	Margin (dB)	Limit (dBuV)	Detector Type
1		0.287	9.782	23.730	33.512	-28.574	62.086	QUASPEAK
2		0.334	9.790	23.530	33.320	-27.423	60.743	QUASPEAK
3		10.005	9.900	25.930	35.830	-24.170	60.000	QUASPEAK
4		12.009	10.008	27.670	37.678	-22.322	60.000	QUASPEAK
5		14.216	10.160	28.430	38.590	-21.410	60.000	QUASPEAK
6	*	27.695	10.320	31.930	42.250	-17.750	60.000	QUASPEAK

Note:

1. All Reading Levels are Quasi-Peak and average value.
2. " * ", means this data is the worst emission level.
3. Measurement Level = Reading Level + Correct Factor

Site : SR_1	Time : 2011/06/17 - 17:36
Limit : CISPR_B_00M_AV	Margin : 0
EUT : Network Camera	Probe : ENV_216_N - Line2
Power : AC 230V/50Hz to DC 12V	Note : Mode 1

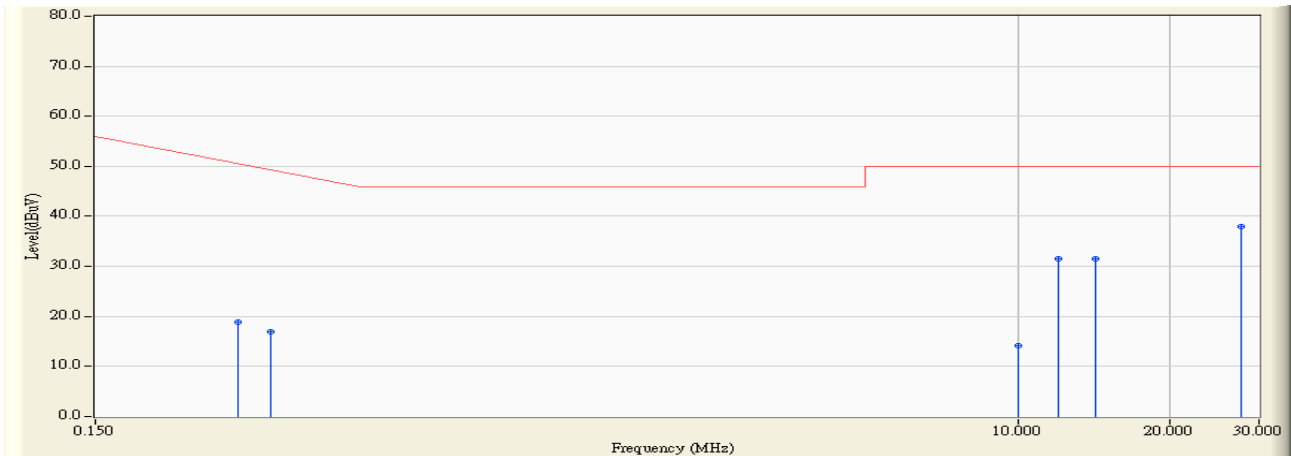

		Frequency (MHz)	Correct Factor (dB)	Reading Level (dBuV)	Measure Level (dBuV)	Margin (dB)	Limit (dBuV)	Detector Type
1		0.287	9.782	9.090	18.872	-33.214	52.086	AVERAGE
2		0.334	9.790	7.200	16.990	-33.753	50.743	AVERAGE
3		10.005	9.900	4.260	14.160	-35.840	50.000	AVERAGE
4		12.009	10.008	21.420	31.428	-18.572	50.000	AVERAGE
5		14.216	10.160	21.420	31.580	-18.420	50.000	AVERAGE
6	*	27.695	10.320	27.680	38.000	-12.000	50.000	AVERAGE

Note:

1. All Reading Levels are Quasi-Peak and average value.
2. " * ", means this data is the worst emission level.
3. Measurement Level = Reading Level + Correct Factor

Site : SR_1	Time : 2011/06/17 - 17:53
Limit : CISPR_B_00M_QP	Margin : 10
EUT : Network Camera	Probe : ENV4200_L1 - Line1
Power : AC 230V/50Hz to AC 24V	Note : Mode 2

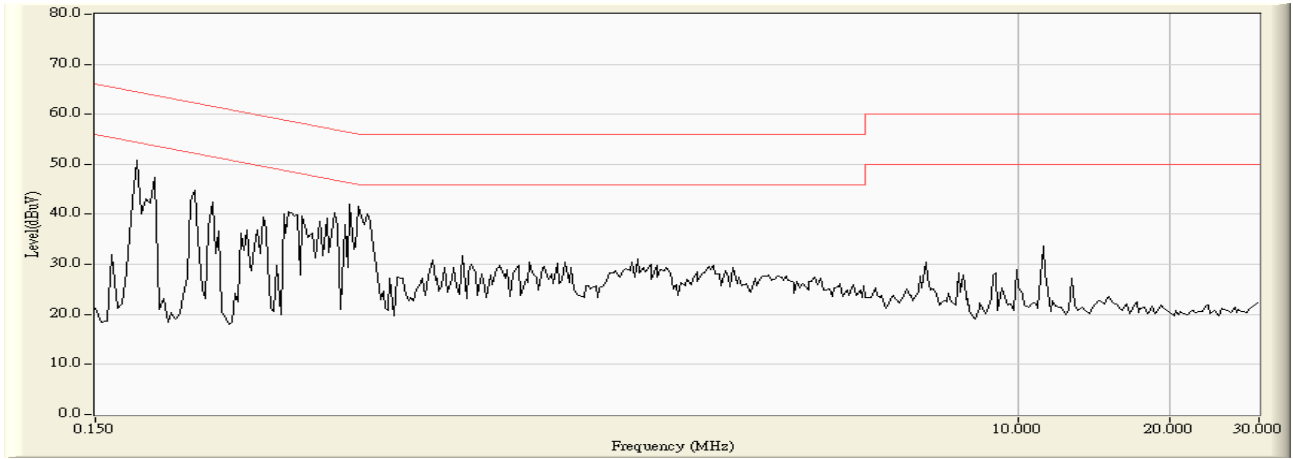

Site : SR_1	Time : 2011/06/17 - 17:54
Limit : CISPR_B_00M_QP	Margin : 0
EUT : Network Camera	Probe : ENV4200_L1 - Line1
Power : AC 230V/50Hz to AC 24V	Note : Mode 2

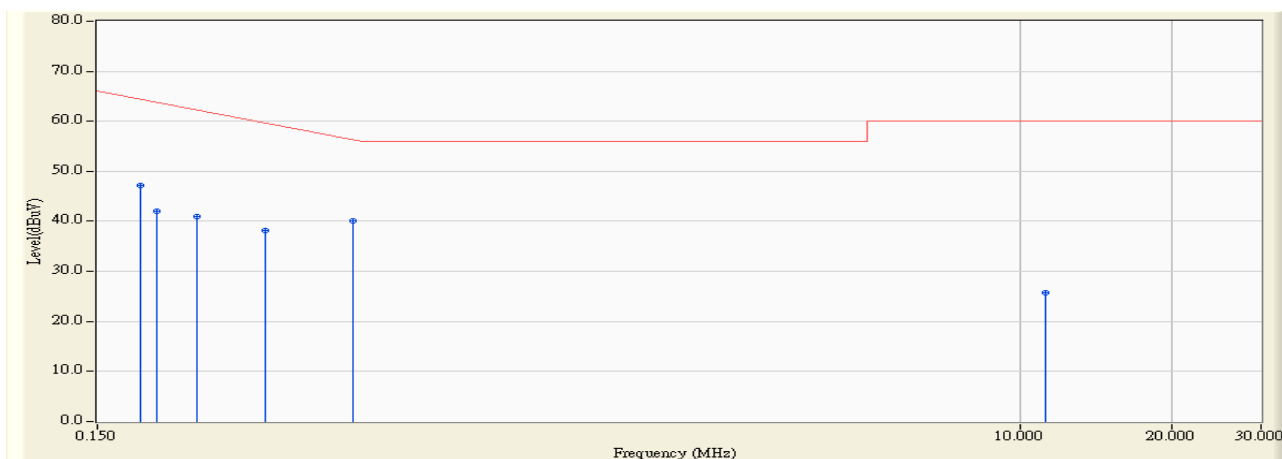

	Frequency (MHz)	Correct Factor (dB)	Reading Level (dBuV)	Measure Level (dBuV)	Margin (dB)	Limit (dBuV)	Detector Type
1	0.183	10.210	37.070	47.280	-17.777	65.057	QUASPEAK
2	0.197	10.210	31.930	42.140	-22.517	64.657	QUASPEAK
3	0.236	10.201	30.790	40.991	-22.552	63.543	QUASPEAK
4	0.322	10.165	28.090	38.255	-22.831	61.086	QUASPEAK
5	* 0.481	10.140	29.990	40.130	-16.413	56.543	QUASPEAK
6	11.252	10.229	15.490	25.719	-34.281	60.000	QUASPEAK

Note:

1. All Reading Levels are Quasi-Peak and average value.
2. " * ", means this data is the worst emission level.
3. Measurement Level = Reading Level + Correct Factor

Site : SR_1	Time : 2011/06/17 - 17:54
Limit : CISPR_B_00M_AV	Margin : 0
EUT : Network Camera	Probe : ENV4200_L1 - Line1
Power : AC 230V/50Hz to AC 24V	Note : Mode 2

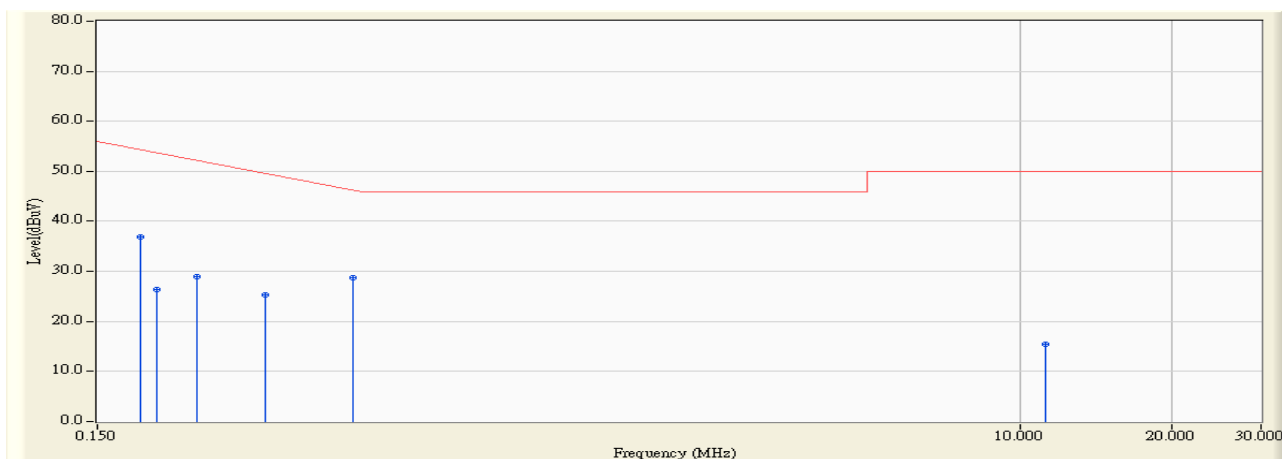

		Frequency (MHz)	Correct Factor (dB)	Reading Level (dBuV)	Measure Level (dBuV)	Margin (dB)	Limit (dBuV)	Detector Type
1		0.183	10.210	26.680	36.890	-18.167	55.057	AVERAGE
2		0.197	10.210	16.200	26.410	-28.247	54.657	AVERAGE
3		0.236	10.201	18.760	28.961	-24.582	53.543	AVERAGE
4		0.322	10.165	15.090	25.255	-25.831	51.086	AVERAGE
5	*	0.481	10.140	18.590	28.730	-17.813	46.543	AVERAGE
6		11.252	10.229	5.300	15.529	-34.471	50.000	AVERAGE

Note:

1. All Reading Levels are Quasi-Peak and average value.
2. " * ", means this data is the worst emission level.
3. Measurement Level = Reading Level + Correct Factor

Site : SR_1	Time : 2011/06/17 - 17:55
Limit : CISPR_B_00M_QP	Margin : 10
EUT : Network Camera	Probe : ENV4200_N - Line2
Power : AC 230V/50Hz to AC 24V	Note : Mode 2

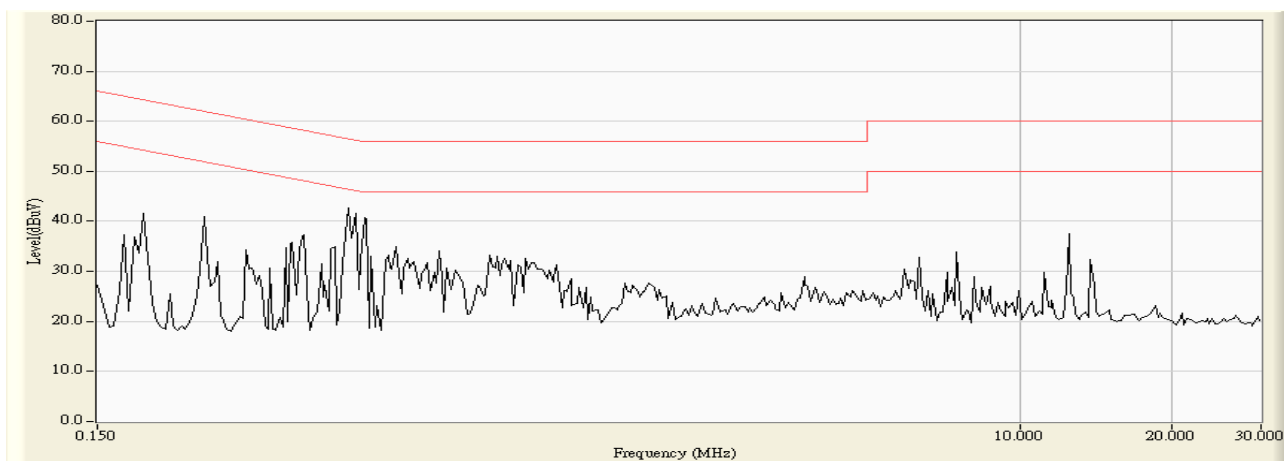

Site : SR_1	Time : 2011/06/17 - 17:57
Limit : CISPR_B_00M_QP	Margin : 0
EUT : Network Camera	Probe : ENV4200_N - Line2
Power : AC 230V/50Hz to AC 24V	Note : Mode 2

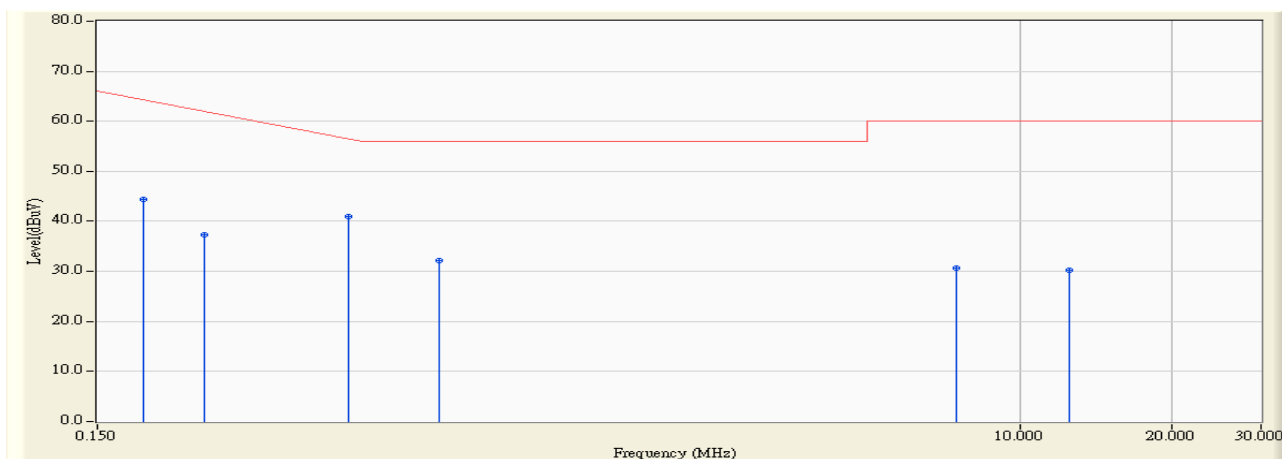

		Frequency (MHz)	Correct Factor (dB)	Reading Level (dBuV)	Measure Level (dBuV)	Margin (dB)	Limit (dBuV)	Detector Type
1		0.185	10.401	33.890	44.291	-20.709	65.000	QUASPEAK
2		0.244	10.461	26.850	37.311	-26.003	63.314	QUASPEAK
3	*	0.470	10.520	30.470	40.990	-15.867	56.857	QUASPEAK
4		0.713	10.568	21.630	32.198	-23.802	56.000	QUASPEAK
5		7.502	10.540	20.130	30.670	-29.330	60.000	QUASPEAK
6		12.502	10.495	19.730	30.225	-29.775	60.000	QUASPEAK

Note:

1. All Reading Levels are Quasi-Peak and average value.
2. " * ", means this data is the worst emission level.
3. Measurement Level = Reading Level + Correct Factor

Site : SR_1	Time : 2011/06/17 - 17:57
Limit : CISPR_B_00M_AV	Margin : 0
EUT : Network Camera	Probe : ENV4200_N - Line2
Power : AC 230V/50Hz to AC 24V	Note : Mode 2

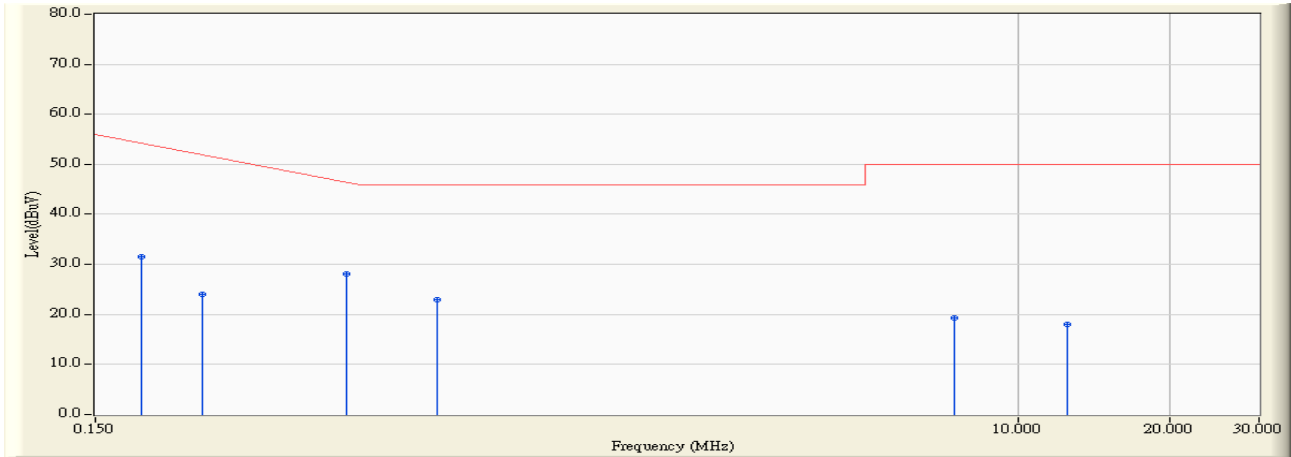

		Frequency (MHz)	Correct Factor (dB)	Reading Level (dBuV)	Measure Level (dBuV)	Margin (dB)	Limit (dBuV)	Detector Type
1		0.185	10.401	21.170	31.571	-23.429	55.000	AVERAGE
2		0.244	10.461	13.520	23.981	-29.333	53.314	AVERAGE
3	*	0.470	10.520	17.620	28.140	-18.717	46.857	AVERAGE
4		0.713	10.568	12.320	22.888	-23.112	46.000	AVERAGE
5		7.502	10.540	8.690	19.230	-30.770	50.000	AVERAGE
6		12.502	10.495	7.500	17.995	-32.005	50.000	AVERAGE

Note:

1. All Reading Levels are Quasi-Peak and average value.
2. " * ", means this data is the worst emission level.
3. Measurement Level = Reading Level + Correct Factor

3.7. Test Photograph

Test Mode : Mode 1: Normal Operation, Adapter : 3A-183WP12

Description : Front View of Conducted Test



Test Mode : Mode 1: Normal Operation, Adapter : 3A-183WP12

Description : Back View of Conducted Test



Test Mode : Mode 2: Normal Operation, Adapter : DE-60-24W

Description : Front View of Conducted Test



Test Mode : Mode 2: Normal Operation, Adapter : DE-60-24W

Description : Back View of Conducted Test



4. Conducted Emissions (Telecommunication Ports)

4.1. Test Specification

According to EMC Standard : EN 55022

4.2. Test Setup

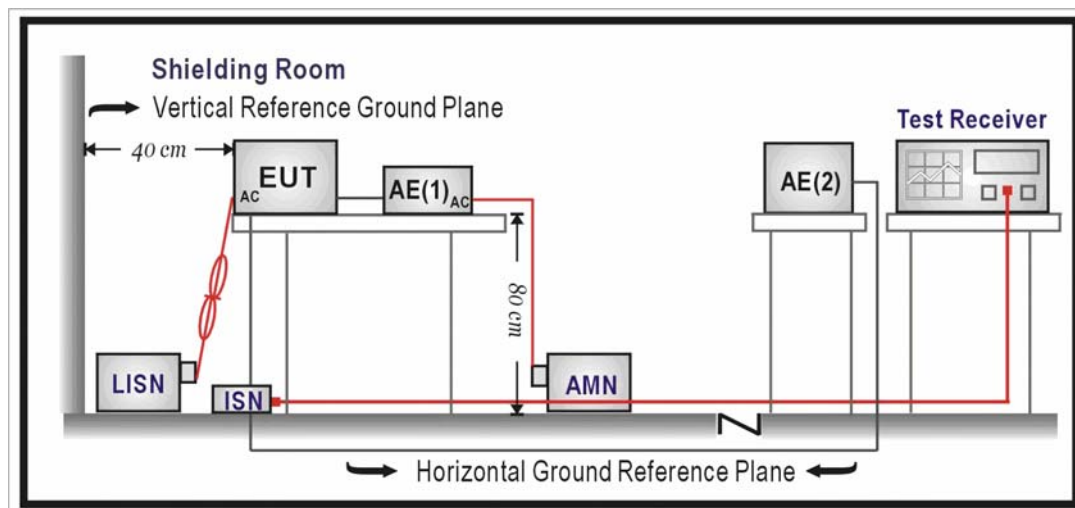

4.3. Limit

Limits		
Frequency (MHz)	QP (dBuV)	AV (dBuV)
0.15 - 0.50	84 – 74	74 – 64
0.50 - 30	74	64

Remarks:

The limit decreases linearly with the logarithm of the frequency in the range 0.15 MHz~0.50 MHz.

4.4. Test Procedure

Telecommunication Port:

The mains voltage shall be supplied to the EUT via the LISN when the measurement of telecommunication port is performed. The common mode disturbances at the telecommunication port shall be connected to the ISN, which is 150 ohm impedance.

Both alternative cables are tested related to the LCL requested. The measurement range is from 150kHz to 30MHz. The bandwidth of measurement is set to 9kHz.

The 75dB LCL ISN is used for cat. 6 cable, the 65dB LCL ISN is used for cat. 5 cable, 55dB LCL ISN is used for cat. 3.

4.5. Deviation from Test Standard

No deviation.

4.6. Test Result

Site : SR_1	Time : 2011/06/28 - 20:29
Limit : ISN_Voltage_B_00M_QP	Margin : 10
EUT : Network Camera	Probe : ISN_T4 - Line1
Power : AC 230V/50Hz to DC 12V	Note : Mode 1, ISN 10M

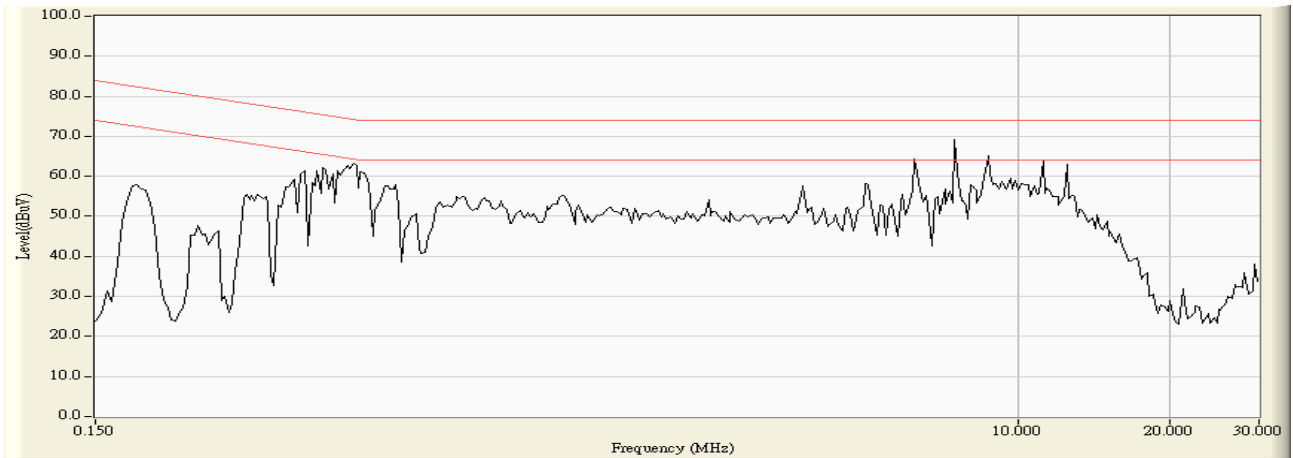

Site : SR_1	Time : 2011/06/28 - 20:30
Limit : ISN_Voltage_B_00M_QP	Margin : 0
EUT : Network Camera	Probe : ISN_T4 - Line1
Power : AC 230V/50Hz to DC 12V	Note : Mode 1, ISN 10M

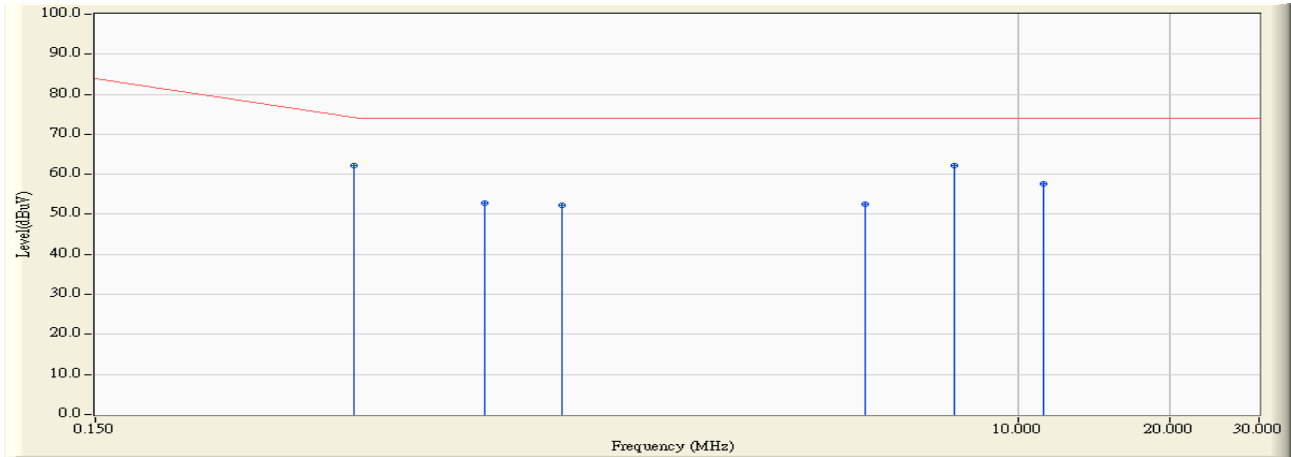

		Frequency (MHz)	Correct Factor (dB)	Reading Level (dBuV)	Measure Level (dBuV)	Margin (dB)	Limit (dBuV)	Detector Type
1		0.486	9.990	52.310	62.300	-12.100	74.400	QUASIPeAK
2		0.884	9.980	42.930	52.910	-21.090	74.000	QUASIPeAK
3		1.255	9.990	42.370	52.360	-21.640	74.000	QUASIPeAK
4		4.998	9.980	42.530	52.510	-21.490	74.000	QUASIPeAK
5	*	7.502	9.970	52.270	62.240	-11.760	74.000	QUASIPeAK
6		11.252	9.960	47.710	57.670	-16.330	74.000	QUASIPeAK

Note:

1. All Reading Levels are Quasi-Peak and average value.
2. " * ", means this data is the worst emission level.
3. Measurement Level = Reading Level + Correct Factor

Site : SR_1	Time : 2011/06/28 - 20:30
Limit : ISN_Voltage_B_00M_AV	Margin : 0
EUT : Network Camera	Probe : ISN_T4 - Line1
Power : AC 230V/50Hz to DC 12V	Note : Mode 1, ISN 10M

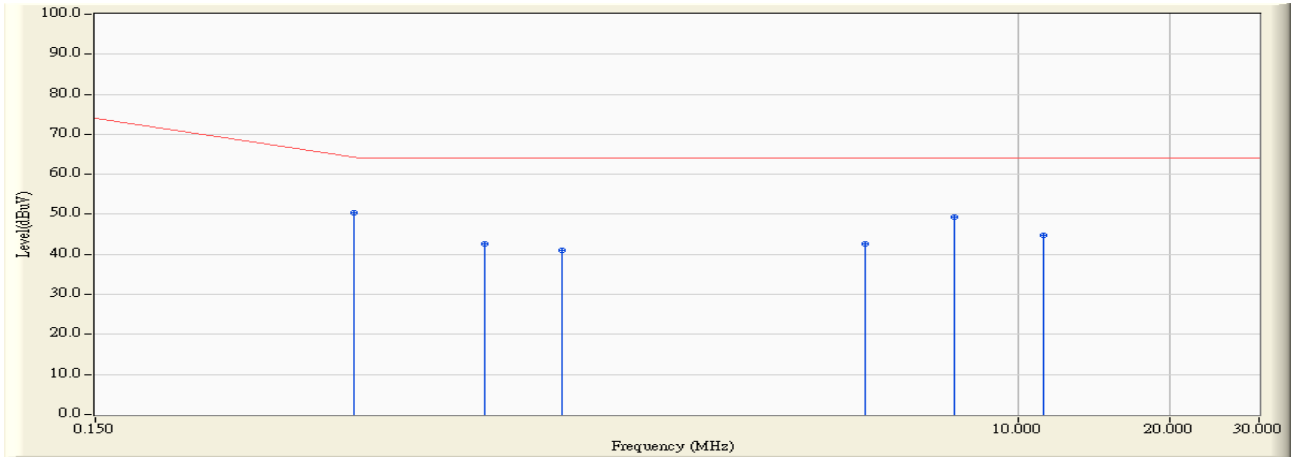

		Frequency (MHz)	Correct Factor (dB)	Reading Level (dBuV)	Measure Level (dBuV)	Margin (dB)	Limit (dBuV)	Detector Type
1	*	0.486	9.990	40.500	50.490	-13.910	64.400	AVERAGE
2		0.884	9.980	32.570	42.550	-21.450	64.000	AVERAGE
3		1.255	9.990	31.040	41.030	-22.970	64.000	AVERAGE
4		4.998	9.980	32.770	42.750	-21.250	64.000	AVERAGE
5		7.502	9.970	39.360	49.330	-14.670	64.000	AVERAGE
6		11.252	9.960	34.690	44.650	-19.350	64.000	AVERAGE

Note:

1. All Reading Levels are Quasi-Peak and average value.
2. " * ", means this data is the worst emission level.
3. Measurement Level = Reading Level + Correct Factor

Site : SR_1	Time : 2011/06/28 - 20:31
Limit : ISN_Voltage_B_00M_QP	Margin : 10
EUT : Network Camera	Probe : ISN_T4 - Line1
Power : AC 230V/50Hz to DC 12V	Note : Mode 1, ISN 100M

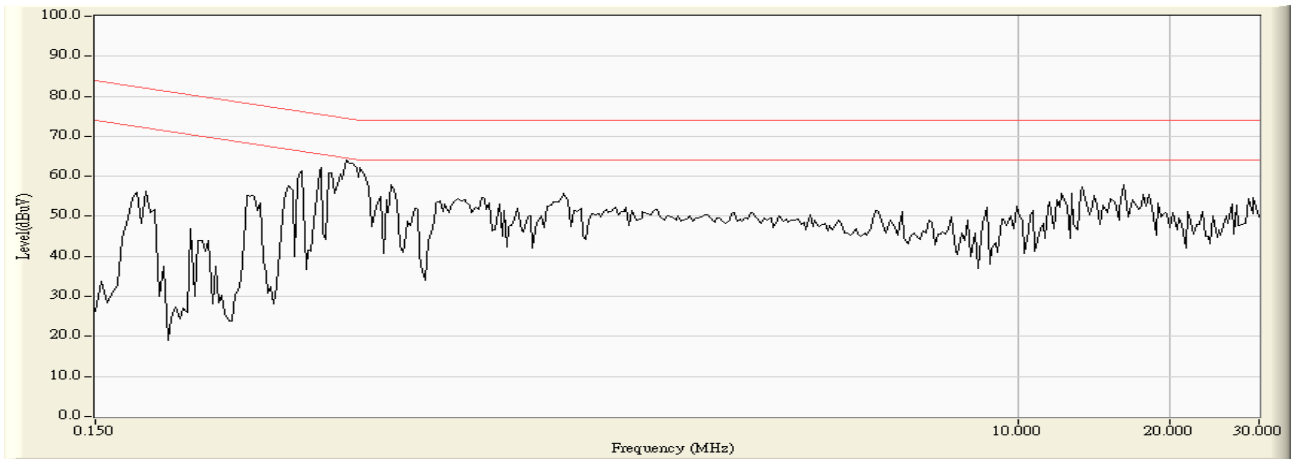

Site : SR_1	Time : 2011/06/28 - 20:32
Limit : ISN_Voltage_B_00M_QP	Margin : 0
EUT : Network Camera	Probe : ISN_T4 - Line1
Power : AC 230V/50Hz to DC 12V	Note : Mode 1, ISN 100M

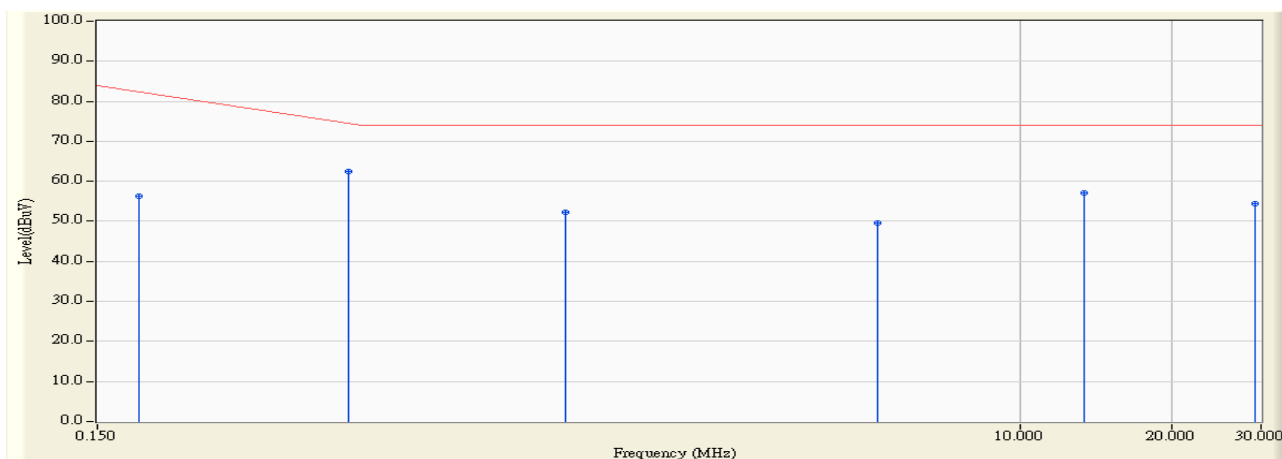

		Frequency (MHz)	Correct Factor (dB)	Reading Level (dBuV)	Measure Level (dBuV)	Margin (dB)	Limit (dBuV)	Detector Type
1		0.181	10.040	46.390	56.430	-26.684	83.114	QUASIPeAK
2	*	0.470	9.993	52.490	62.483	-12.374	74.857	QUASIPeAK
3		1.267	9.990	42.390	52.380	-21.620	74.000	QUASIPeAK
4		5.240	9.980	39.610	49.590	-24.410	74.000	QUASIPeAK
5		13.420	10.150	46.890	57.040	-16.960	74.000	QUASIPeAK
6		29.236	10.080	44.450	54.530	-19.470	74.000	QUASIPeAK

Note:

1. All Reading Levels are Quasi-Peak and average value.
2. " * ", means this data is the worst emission level.
3. Measurement Level = Reading Level + Correct Factor

Site : SR_1	Time : 2011/06/28 - 20:32
Limit : ISN_Voltage_B_00M_AV	Margin : 0
EUT : Network Camera	Probe : ISN_T4 - Line1
Power : AC 230V/50Hz to DC 12V	Note : Mode 1, ISN 100M

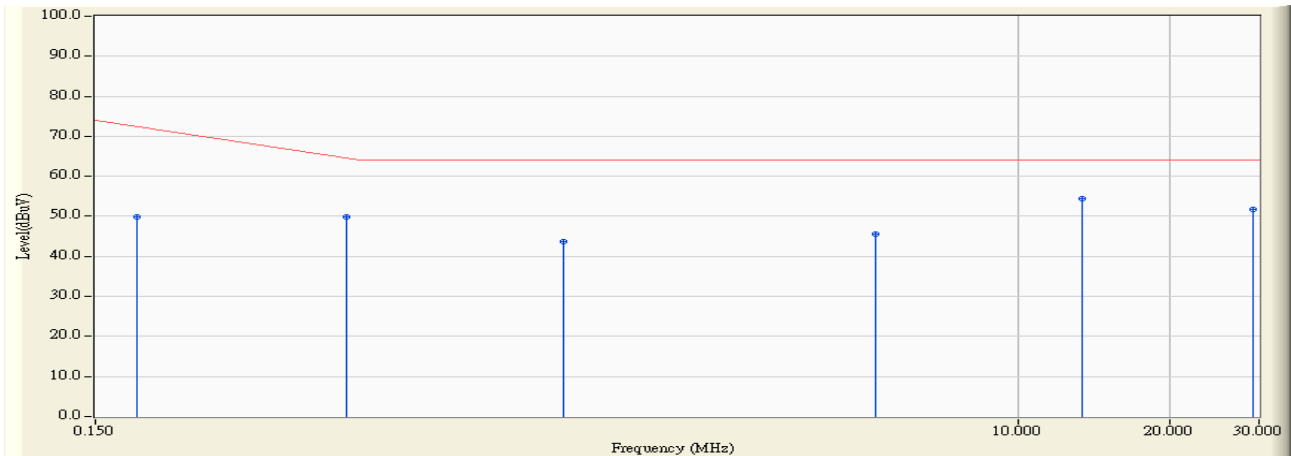

		Frequency (MHz)	Correct Factor (dB)	Reading Level (dBuV)	Measure Level (dBuV)	Margin (dB)	Limit (dBuV)	Detector Type
1		0.181	10.040	39.830	49.870	-23.244	73.114	AVERAGE
2		0.470	9.993	39.890	49.883	-14.974	64.857	AVERAGE
3		1.267	9.990	33.750	43.740	-20.260	64.000	AVERAGE
4		5.240	9.980	35.590	45.570	-18.430	64.000	AVERAGE
5	*	13.420	10.150	44.340	54.490	-9.510	64.000	AVERAGE
6		29.236	10.080	41.650	51.730	-12.270	64.000	AVERAGE

Note:

1. All Reading Levels are Quasi-Peak and average value.
2. " * ", means this data is the worst emission level.
3. Measurement Level = Reading Level + Correct Factor

Site : SR_1	Time : 2011/06/17 - 17:59
Limit : ISN_Voltage_B_00M_QP	Margin : 10
EUT : Network Camera	Probe : ISN_T4 - Line1
Power : AC 230V/50Hz to AC 24V	Note : Mode 2, ISN 10M

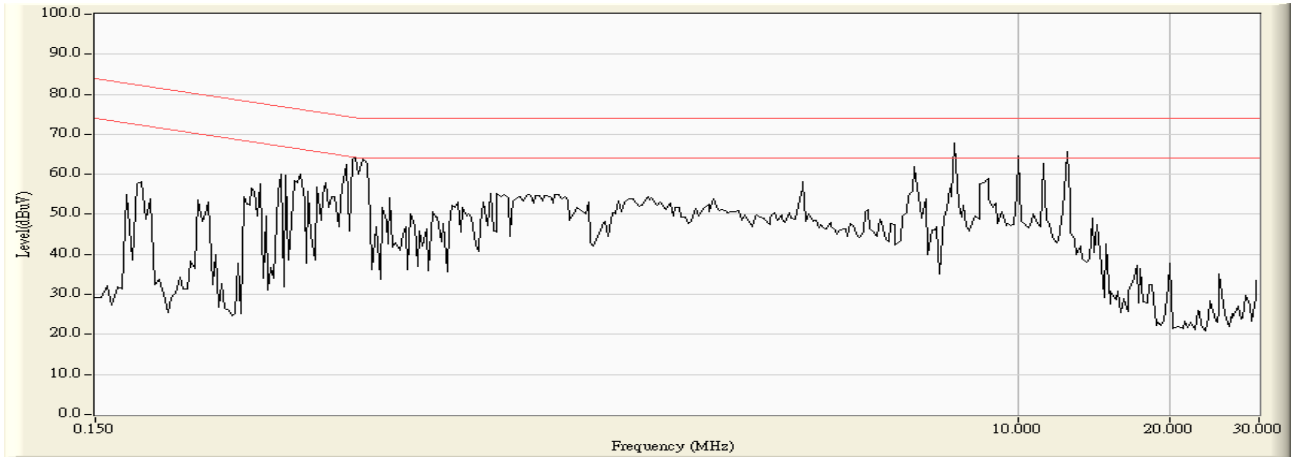

Site : SR_1	Time : 2011/06/17 - 18:01
Limit : ISN_Voltage_B_00M_QP	Margin : 0
EUT : Network Camera	Probe : ISN_T4 - Line1
Power : AC 230V/50Hz to AC 24V	Note : Mode 2, ISN 10M

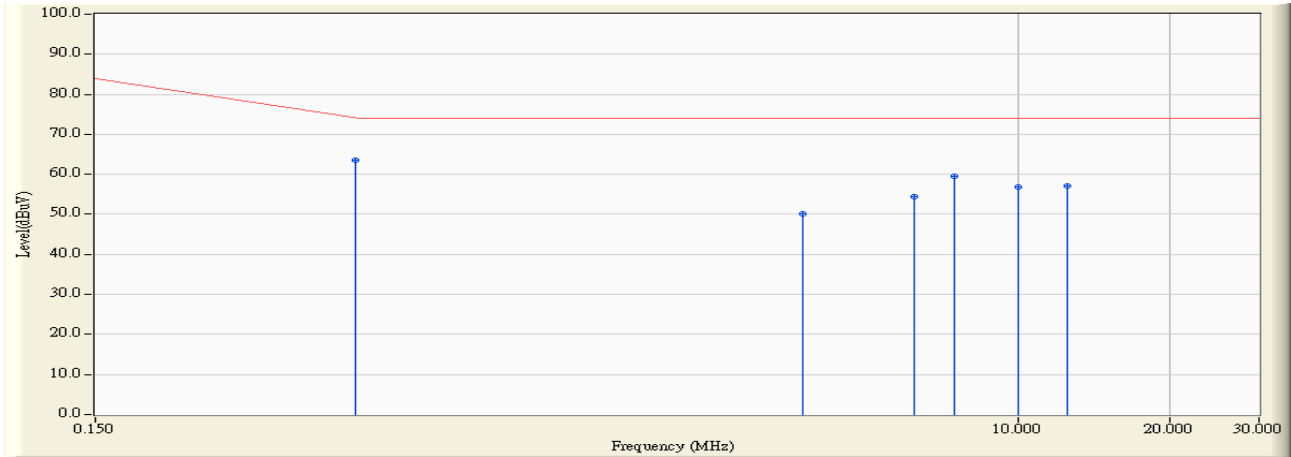

		Frequency (MHz)	Correct Factor (dB)	Reading Level (dBuV)	Measure Level (dBuV)	Margin (dB)	Limit (dBuV)	Detector Type
1	*	0.490	9.990	53.570	63.560	-10.726	74.286	QUASIPeAK
2		3.752	9.990	40.110	50.100	-23.900	74.000	QUASIPeAK
3		6.248	9.977	44.490	54.467	-19.533	74.000	QUASIPeAK
4		7.502	9.970	49.650	59.620	-14.380	74.000	QUASIPeAK
5		10.002	9.960	46.770	56.730	-17.270	74.000	QUASIPeAK
6		12.502	10.073	46.950	57.023	-16.977	74.000	QUASIPeAK

Note:

1. All Reading Levels are Quasi-Peak and average value.
2. " * ", means this data is the worst emission level.
3. Measurement Level = Reading Level + Correct Factor

Site : SR_1	Time : 2011/06/17 - 18:01
Limit : ISN_Voltage_B_00M_AV	Margin : 0
EUT : Network Camera	Probe : ISN_T4 - Line1
Power : AC 230V/50Hz to AC 24V	Note : Mode 2, ISN 10M

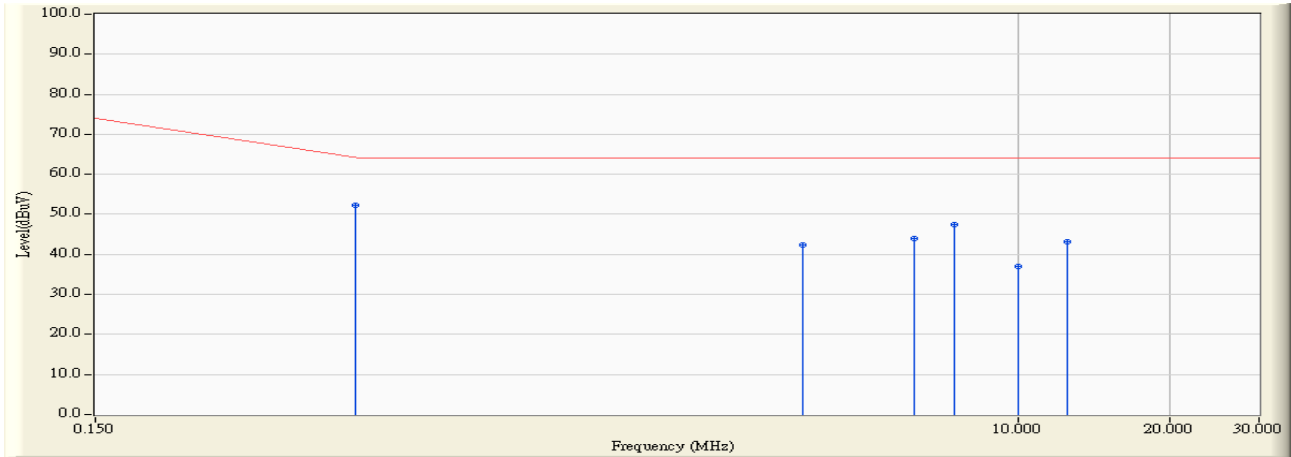

		Frequency (MHz)	Correct Factor (dB)	Reading Level (dBuV)	Measure Level (dBuV)	Margin (dB)	Limit (dBuV)	Detector Type
1	*	0.490	9.990	42.330	52.320	-11.966	64.286	AVERAGE
2		3.752	9.990	32.300	42.290	-21.710	64.000	AVERAGE
3		6.248	9.977	33.870	43.847	-20.153	64.000	AVERAGE
4		7.502	9.970	37.520	47.490	-16.510	64.000	AVERAGE
5		10.002	9.960	27.000	36.960	-27.040	64.000	AVERAGE
6		12.502	10.073	33.210	43.283	-20.717	64.000	AVERAGE

Note:

1. All Reading Levels are Quasi-Peak and average value.
2. " * ", means this data is the worst emission level.
3. Measurement Level = Reading Level + Correct Factor

Site : SR_1	Time : 2011/06/17 - 18:02
Limit : ISN_Voltage_B_00M_QP	Margin : 10
EUT : Network Camera	Probe : ISN_T4 - Line1
Power : AC 230V/50Hz to AC 24V	Note : Mode 2, ISN 100M

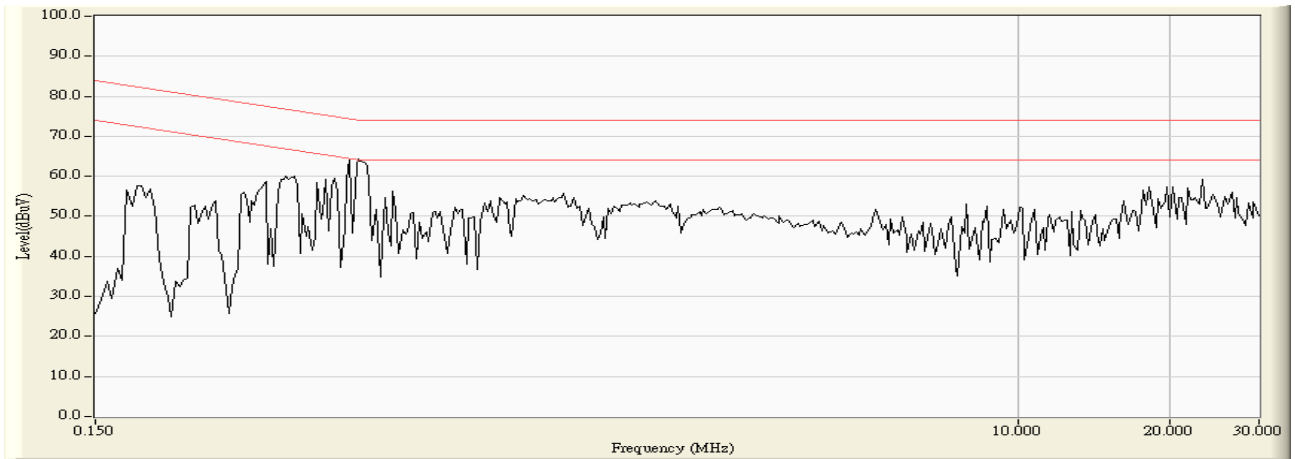

Site : SR_1	Time : 2011/06/17 - 18:03
Limit : ISN_Voltage_B_00M_QP	Margin : 0
EUT : Network Camera	Probe : ISN_T4 - Line1
Power : AC 230V/50Hz to AC 24V	Note : Mode 2, ISN 100M

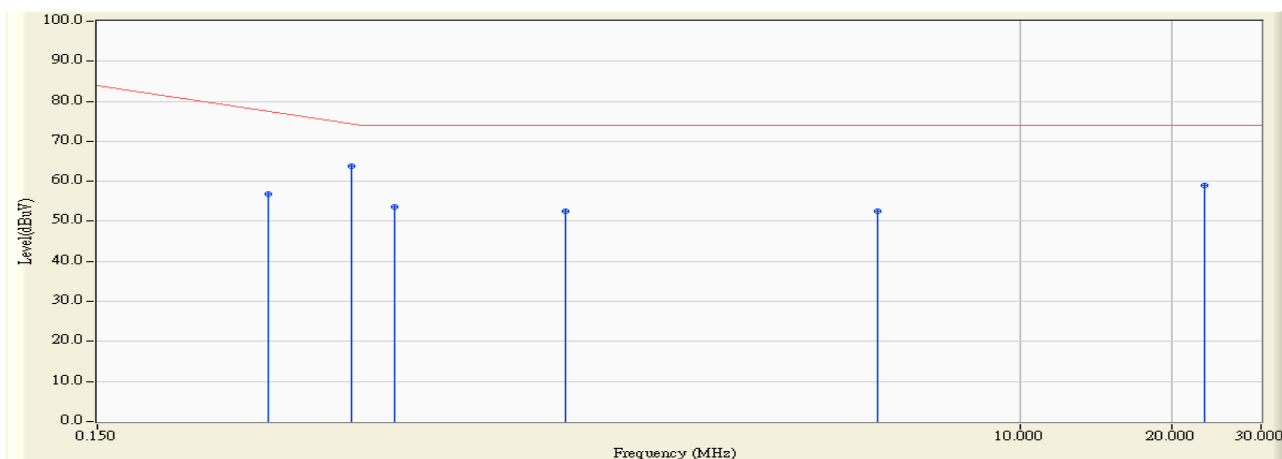

		Frequency (MHz)	Correct Factor (dB)	Reading Level (dBuV)	Measure Level (dBuV)	Margin (dB)	Limit (dBuV)	Detector Type
1		0.326	10.011	46.830	56.841	-22.130	78.971	QUASIPeAK
2	*	0.478	9.990	53.830	63.820	-10.809	74.629	QUASIPeAK
3		0.580	9.990	43.590	53.580	-20.420	74.000	QUASIPeAK
4		1.267	9.990	42.430	52.420	-21.580	74.000	QUASIPeAK
5		5.236	9.980	42.610	52.590	-21.410	74.000	QUASIPeAK
6		23.130	10.100	48.890	58.990	-15.010	74.000	QUASIPeAK

Note:

1. All Reading Levels are Quasi-Peak and average value.
2. " * ", means this data is the worst emission level.
3. Measurement Level = Reading Level + Correct Factor

Site : SR_1	Time : 2011/06/17 - 18:03
Limit : ISN_Voltage_B_00M_AV	Margin : 0
EUT : Network Camera	Probe : ISN_T4 - Line1
Power : AC 230V/50Hz to AC 24V	Note : Mode 2, ISN 100M

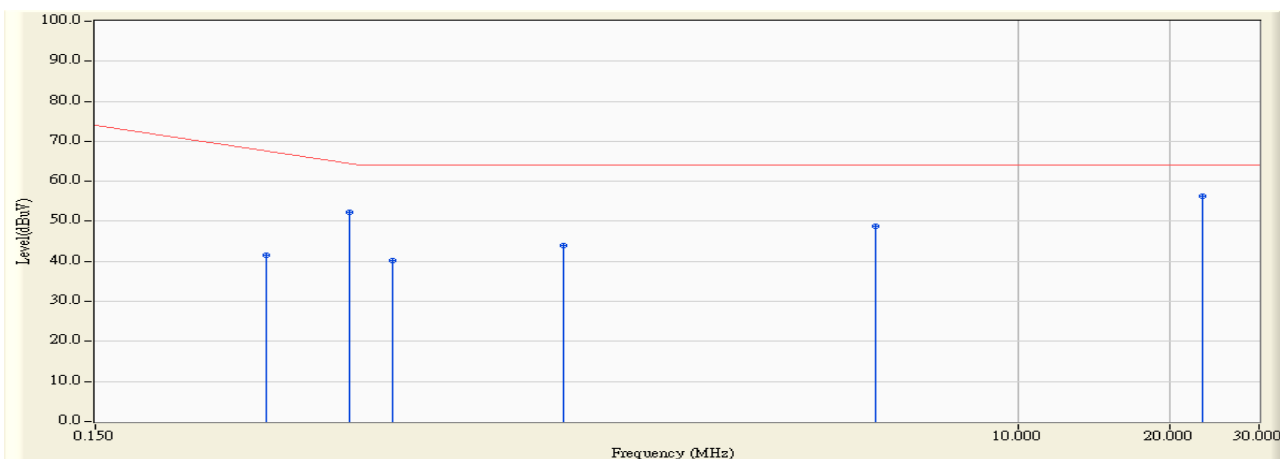

		Frequency (MHz)	Correct Factor (dB)	Reading Level (dBuV)	Measure Level (dBuV)	Margin (dB)	Limit (dBuV)	Detector Type
1		0.326	10.011	31.650	41.661	-27.310	68.971	AVERAGE
2		0.478	9.990	42.330	52.320	-12.309	64.629	AVERAGE
3		0.580	9.990	30.200	40.190	-23.810	64.000	AVERAGE
4		1.267	9.990	33.930	43.920	-20.080	64.000	AVERAGE
5		5.236	9.980	38.720	48.700	-15.300	64.000	AVERAGE
6	*	23.130	10.100	46.300	56.400	-7.600	64.000	AVERAGE

Note:

1. All Reading Levels are Quasi-Peak and average value.
2. " * ", means this data is the worst emission level.
3. Measurement Level = Reading Level + Correct Factor

Site : SR_1	Time : 2011/06/17 - 18:37
Limit : ISN_Voltage_B_00M_QP	Margin : 10
EUT : Network Camera	Probe : CVP-2200A - Line1
Power : POE	Note : Mode 3, ISN 10M

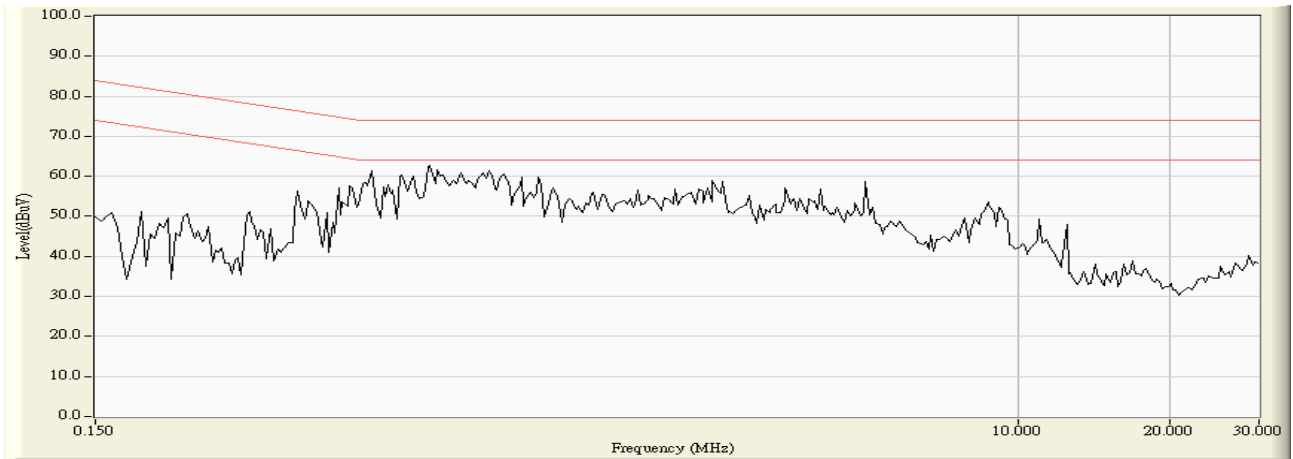

Site : SR_1	Time : 2011/06/17 - 18:39
Limit : ISN_Voltage_B_00M_QP	Margin : 0
EUT : Network Camera	Probe : CVP-2200A - Line1
Power : POE	Note : Mode 3, ISN 10M

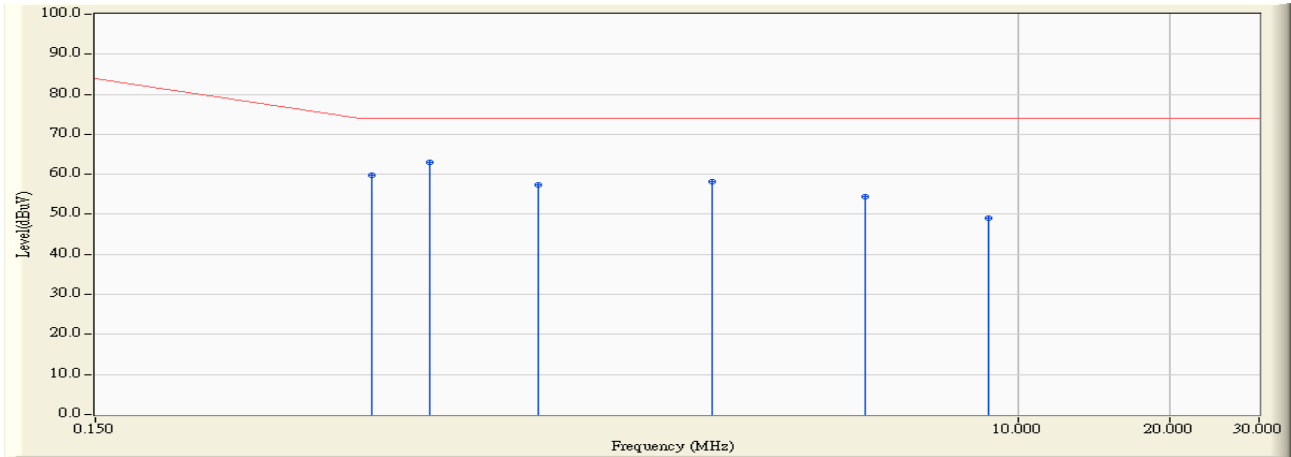

		Frequency (MHz)	Correct Factor (dB)	Reading Level (dBuV)	Measure Level (dBuV)	Margin (dB)	Limit (dBuV)	Detector Type
1		0.529	20.200	39.670	59.870	-14.130	74.000	QUASIPeAK
2	*	0.689	20.200	42.790	62.990	-11.010	74.000	QUASIPeAK
3		1.130	20.200	37.230	57.430	-16.570	74.000	QUASIPeAK
4		2.494	20.200	38.010	58.210	-15.790	74.000	QUASIPeAK
5		5.009	20.200	34.290	54.490	-19.510	74.000	QUASIPeAK
6		8.752	20.200	28.930	49.130	-24.870	74.000	QUASIPeAK

Note:

1. All Reading Levels are Quasi-Peak and average value.
2. " * ", means this data is the worst emission level.
3. Measurement Level = Reading Level + Correct Factor

Site : SR_1	Time : 2011/06/17 - 18:39
Limit : ISN_Voltage_B_00M_AV	Margin : 0
EUT : Network Camera	Probe : CVP-2200A - Line1
Power : POE	Note : Mode 3, ISN 10M

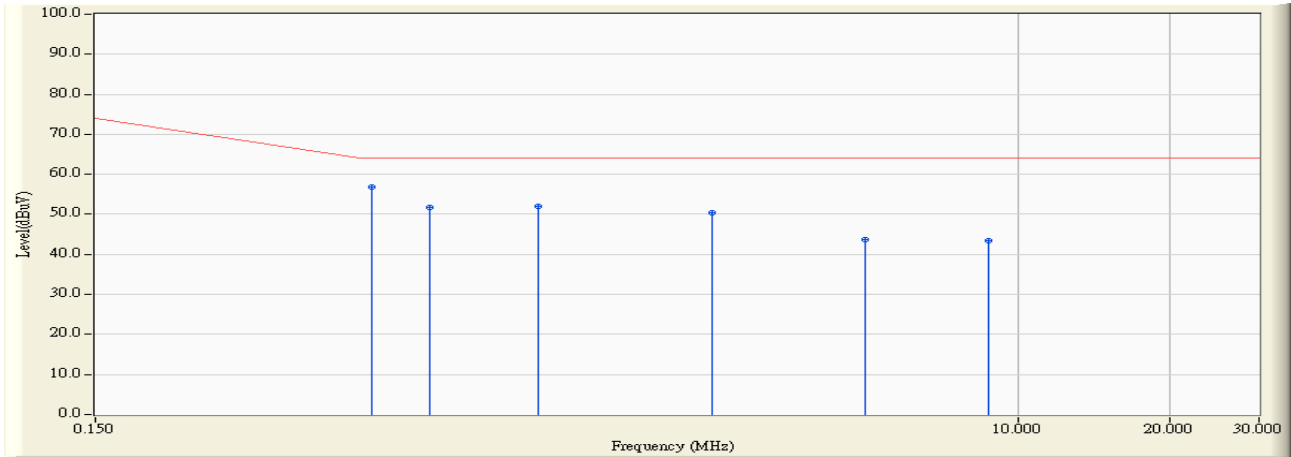

		Frequency (MHz)	Correct Factor (dB)	Reading Level (dBuV)	Measure Level (dBuV)	Margin (dB)	Limit (dBuV)	Detector Type
1	*	0.529	20.200	36.650	56.850	-7.150	64.000	AVERAGE
2		0.689	20.200	31.580	51.780	-12.220	64.000	AVERAGE
3		1.130	20.200	31.730	51.930	-12.070	64.000	AVERAGE
4		2.494	20.200	30.200	50.400	-13.600	64.000	AVERAGE
5		5.009	20.200	23.400	43.600	-20.400	64.000	AVERAGE
6		8.752	20.200	23.160	43.360	-20.640	64.000	AVERAGE

Note:

1. All Reading Levels are Quasi-Peak and average value.
2. " * ", means this data is the worst emission level.
3. Measurement Level = Reading Level + Correct Factor

Site : SR_1	Time : 2011/06/17 - 18:33
Limit : ISN_Voltage_B_00M_QP	Margin : 10
EUT : Network Camera	Probe : CVP-2200A - Line1
Power : POE	Note : Mode 3, ISN 100M

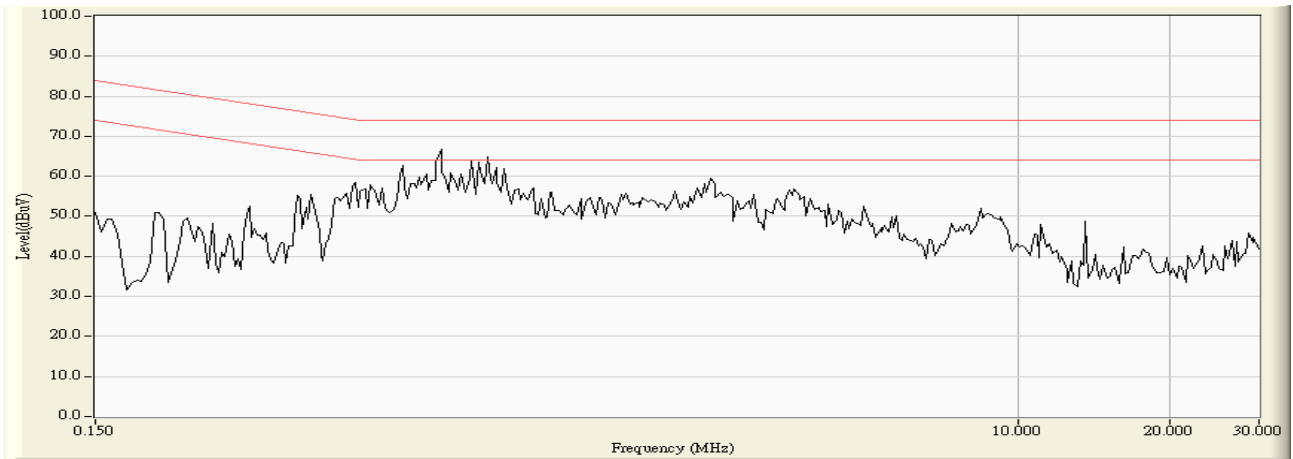

Site : SR_1	Time : 2011/06/17 - 18:36
Limit : ISN_Voltage_B_00M_QP	Margin : 0
EUT : Network Camera	Probe : CVP-2200A - Line1
Power : POE	Note : Mode 3, ISN 100M

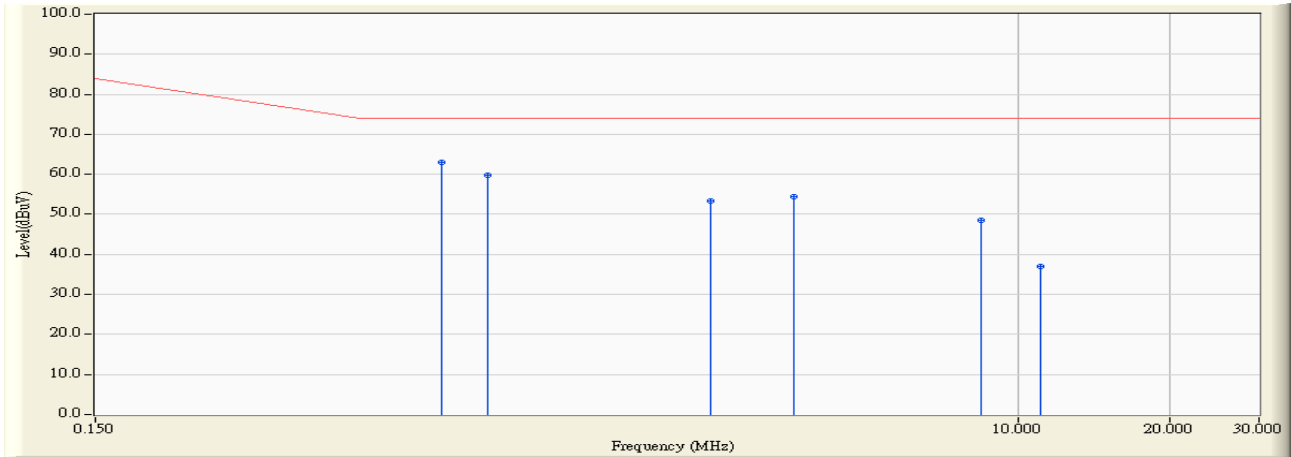

		Frequency (MHz)	Correct Factor (dB)	Reading Level (dBuV)	Measure Level (dBuV)	Margin (dB)	Limit (dBuV)	Detector Type
1	*	0.724	20.200	42.910	63.110	-10.890	74.000	QUASIPeAK
2		0.896	20.200	39.610	59.810	-14.190	74.000	QUASIPeAK
3		2.462	20.200	33.170	53.370	-20.630	74.000	QUASIPeAK
4		3.619	20.200	34.110	54.310	-19.690	74.000	QUASIPeAK
5		8.459	20.200	28.250	48.450	-25.550	74.000	QUASIPeAK
6		11.123	20.200	16.830	37.030	-36.970	74.000	QUASIPeAK

Note:

1. All Reading Levels are Quasi-Peak and average value.
2. " * ", means this data is the worst emission level.
3. Measurement Level = Reading Level + Correct Factor

Site : SR_1	Time : 2011/06/17 - 18:36
Limit : ISN_Voltage_B_00M_AV	Margin : 0
EUT : Network Camera	Probe : CVP-2200A - Line1
Power : POE	Note : Mode 3, ISN 100M

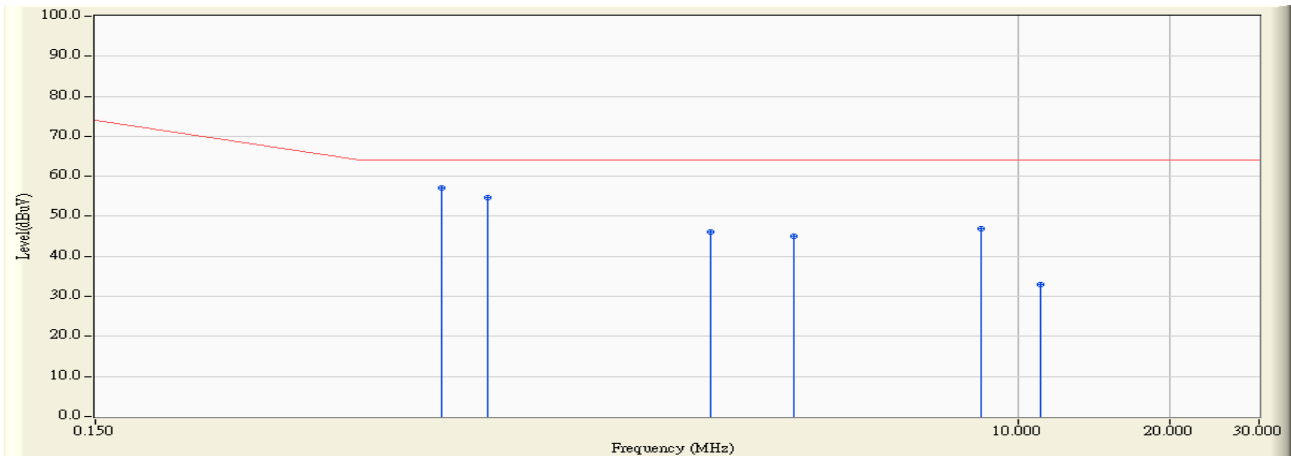

		Frequency (MHz)	Correct Factor (dB)	Reading Level (dBuV)	Measure Level (dBuV)	Margin (dB)	Limit (dBuV)	Detector Type
1	*	0.724	20.200	36.940	57.140	-6.860	64.000	AVERAGE
2		0.896	20.200	34.360	54.560	-9.440	64.000	AVERAGE
3		2.462	20.200	25.920	46.120	-17.880	64.000	AVERAGE
4		3.619	20.200	24.710	44.910	-19.090	64.000	AVERAGE
5		8.459	20.200	26.630	46.830	-17.170	64.000	AVERAGE
6		11.123	20.200	12.800	33.000	-31.000	64.000	AVERAGE

Note:

1. All Reading Levels are Quasi-Peak and average value.
2. " * ", means this data is the worst emission level.
3. Measurement Level = Reading Level + Correct Factor

4.7. Test Photograph

Test Mode : Mode 1: Normal Operation, Adapter : 3A-183WP12

Description : Front View of ISN Test



Test Mode : Mode 1: Normal Operation, Adapter : 3A-183WP12

Description : Back View of ISN Test



Test Mode : Mode 2: Normal Operation, Adapter : DE-60-24W

Description : Front View of ISN Test



Test Mode : Mode 2: Normal Operation, Adapter : DE-60-24W

Description : Back View of ISN Test



Test Mode : Mode 3: Normal Operation, PoE

Description : Front View of ISN Test



Test Mode : Mode 3: Normal Operation, PoE

Description : Back View of ISN Test



5. Radiated Emission

5.1. Test Specification

According to EMC Standard : EN 55022

5.2. Test Setup

Under 1GHz Test Setup:

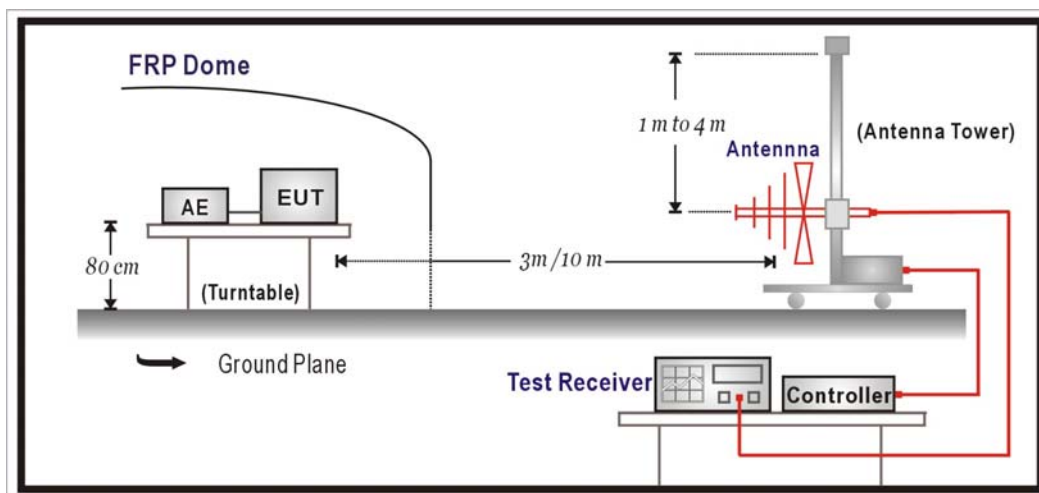

Above 1GHz Test Setup:

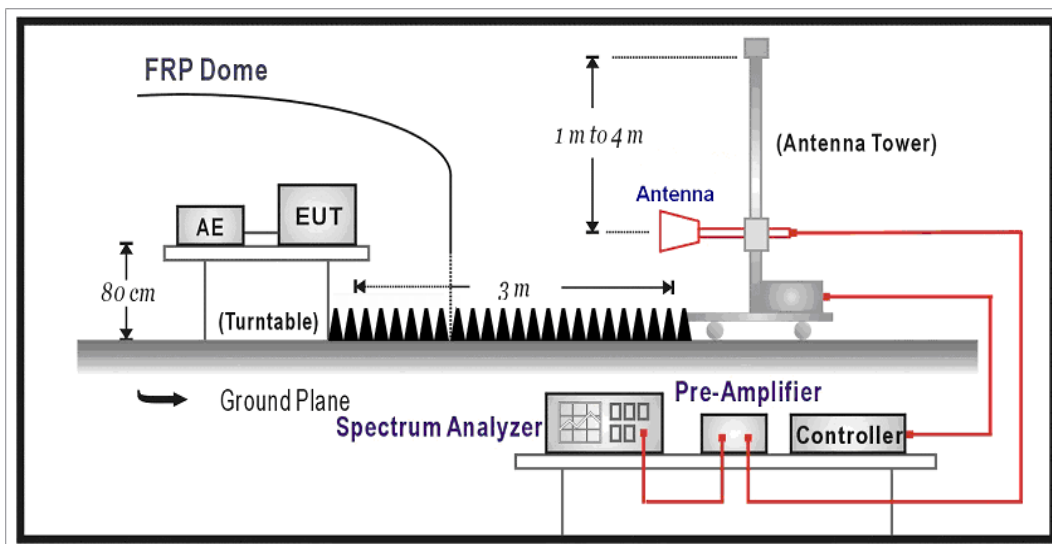

5.3. Limit

Limits		
Frequency (MHz)	Distance (m)	dBuV/m
30 – 230	10	30
230 – 1000	10	37

Limits			
Frequency (GHz)	Distance (m)	Peak (dBuV/m)	Average (dBuV/m)
1 – 3	3	70	50
3 – 6	3	74	54

Remark:

1. The tighter limit shall apply at the edge between two frequency bands.
2. Distance refers to the distance in meters between the measuring instrument antenna and the closed point of any part of the device or system.

Highest frequency generated or used in the device or on which the device operates or tunes (MHz)	Upper frequency of measurement range (MHz)
Below 108	1000
108 – 500	2000
500 – 1000	5000
Above 1000	5 th harmonic of the highest frequency or 6 GHz, whichever is lower

5.4. Test Procedure

The EUT and its simulators are placed on a turn table which is 0.8 meter above ground. The turn table can rotate 360 degrees to determine the position of the maximum emission level. The EUT was positioned such that the distance from antenna to the EUT was 3/10 meters. The antenna can move up and down between 1 meter and 4 meters to find out the maximum emission level.

Both horizontal and vertical polarization of the antenna are set on measurement. In order to find the maximum emission, all of the interface cables must be manipulated on radiated measurement.

Radiated emissions were investigated over the frequency range from 30MHz to 1GHz using a receiver bandwidth of 120kHz and above 1GHz using a receiver bandwidth of 1MHz.

30MHz to 1GHz Radiated was performed at an antenna to EUT distance of 10 meters.

Above 1GHz Radiated was performed at an antenna to EUT distance of 3 meters.

It is placed with absorb on the ground between EUT and Antenna.

5.5. Deviation from Test Standard

No deviation.

5.6. Test Result

Site : OATS-1	Time : 2011/06/17 - 23:52
Limit : CISPR_B_10M_QP	Margin : 6
EUT : Network Camera	Probe : Site1_CBL6112_10M_0811 - HORIZONTAL
Power : AC 230V/50Hz to DC 12V	Note : Mode 1

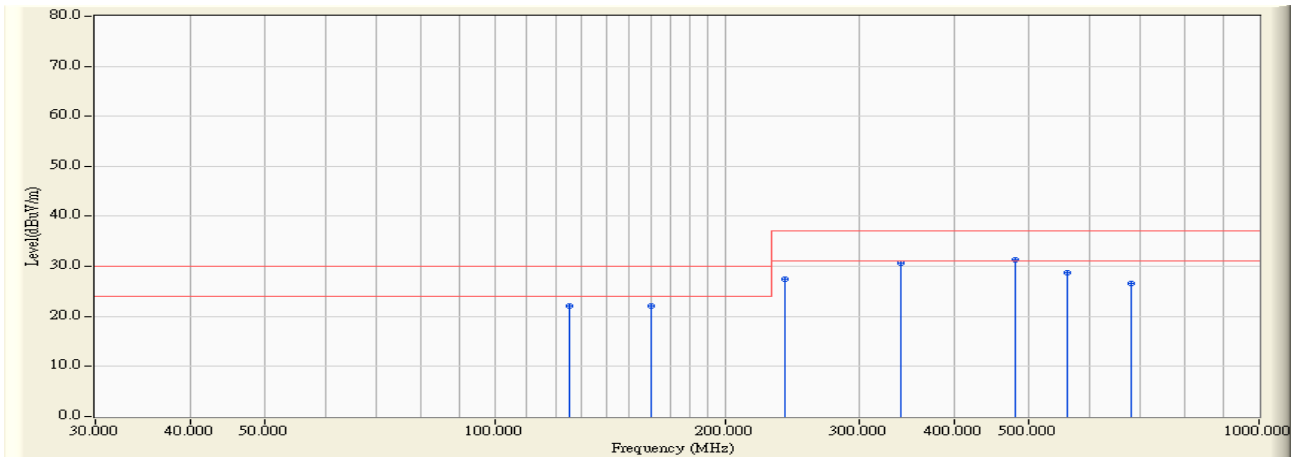

	Frequency (MHz)	Correct Factor (dB)	Reading Level (dBuV)	Measure Level (dBuV/m)	Margin (dB)	Limit (dBuV/m)	Detector Type
1	125.000	13.570	8.600	22.170	-7.830	30.000	QUASPEAK
2	160.000	11.519	10.600	22.118	-7.882	30.000	QUASPEAK
3	240.000	13.300	14.200	27.500	-9.500	37.000	QUASPEAK
4	339.990	17.009	13.600	30.608	-6.392	37.000	QUASPEAK
5	* 480.000	20.693	10.600	31.293	-5.707	37.000	QUASPEAK
6	560.000	22.500	6.200	28.700	-8.300	37.000	QUASPEAK
7	679.980	23.100	3.600	26.700	-10.300	37.000	QUASPEAK

Note:

1. All Readings below 1GHz are Quasi-Peak, above are performed with peak and/or average measurements as necessary.
2. " * ", means this data is the worst emission level.
3. Measurement Level = Reading Level + Correct Factor

Site : OATS-1	Time : 2011/06/17 - 23:32
Limit : CISPR_B_10M_QP	Margin : 6
EUT : Network Camera	Probe : Site1_CBL6112_10M_0811 - VERTICAL
Power : AC 230V/50Hz to DC 12V	Note : Mode 1

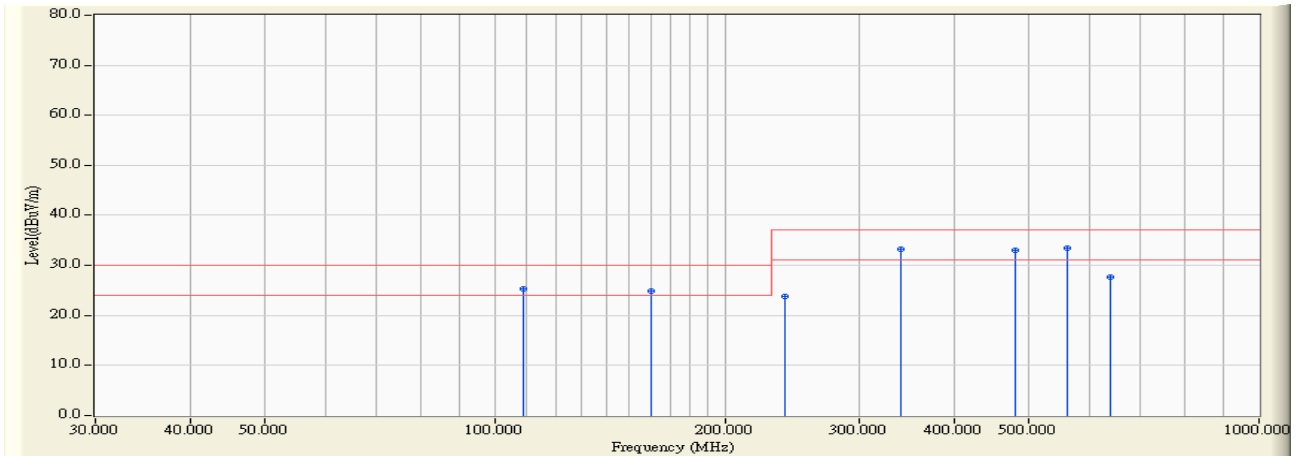

		Frequency (MHz)	Correct Factor (dB)	Reading Level (dBuV)	Measure Level (dBuV/m)	Margin (dB)	Limit (dBuV/m)	Detector Type
1		108.770	12.939	12.300	25.239	-4.761	30.000	QUASPEAK
2		160.000	11.519	13.400	24.918	-5.082	30.000	QUASPEAK
3		240.000	13.300	10.600	23.900	-13.100	37.000	QUASPEAK
4		339.990	17.009	16.200	33.208	-3.792	37.000	QUASPEAK
5		480.000	20.693	12.400	33.093	-3.907	37.000	QUASPEAK
6	*	560.000	22.500	11.000	33.500	-3.500	37.000	QUASPEAK
7		640.000	23.050	4.600	27.650	-9.350	37.000	QUASPEAK

Note:

1. All Readings below 1GHz are Quasi-Peak, above are performed with peak and/or average measurements as necessary.
2. " * ", means this data is the worst emission level.
3. Measurement Level = Reading Level + Correct Factor

Site : OATS-1	Time : 2011/06/18 - 01:00
Limit : CISPR_B_10M_QP	Margin : 6
EUT : Network Camera	Probe : Site1_CBL6112_10M_0811 - HORIZONTAL
Power : AC 230V/50Hz to AC 24V	Note : Mode 2

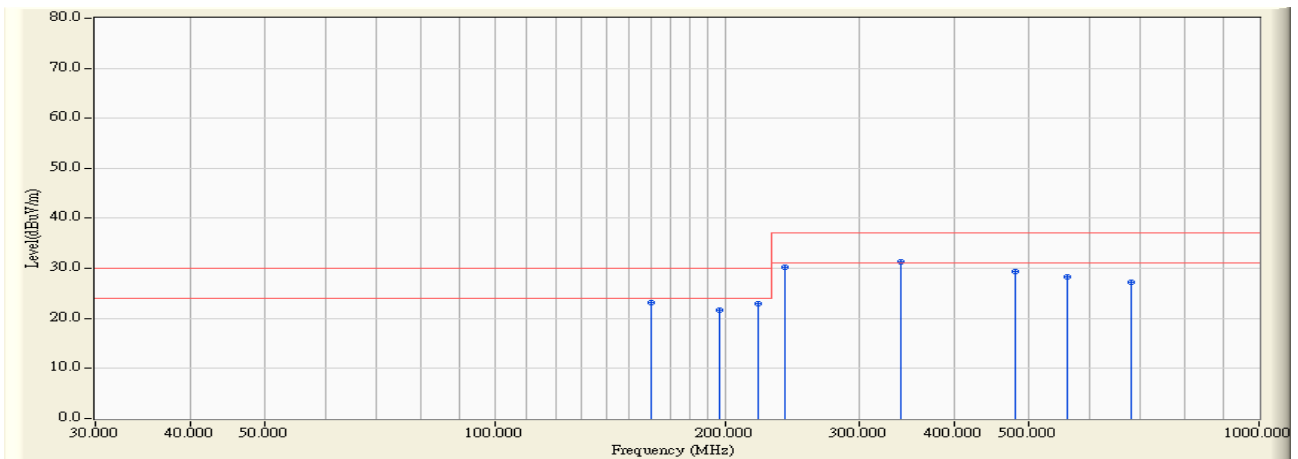

		Frequency (MHz)	Correct Factor (dB)	Reading Level (dBuV)	Measure Level (dBuV/m)	Margin (dB)	Limit (dBuV/m)	Detector Type
1		160.000	11.519	11.600	23.118	-6.882	30.000	QUASIPeAK
2		196.600	10.930	10.700	21.630	-8.370	30.000	QUASIPeAK
3		221.200	11.046	11.800	22.846	-7.154	30.000	QUASIPeAK
4		240.000	13.300	17.000	30.300	-6.700	37.000	QUASIPeAK
5	*	339.990	17.009	14.200	31.208	-5.792	37.000	QUASIPeAK
6		480.000	20.693	8.600	29.293	-7.707	37.000	QUASIPeAK
7		560.000	22.500	5.900	28.400	-8.600	37.000	QUASIPeAK
8		679.980	23.100	4.200	27.300	-9.700	37.000	QUASIPeAK

Note:

1. All Readings below 1GHz are Quasi-Peak, above are performed with peak and/or average measurements as necessary.
2. " * ", means this data is the worst emission level.
3. Measurement Level = Reading Level + Correct Factor

Site : OATS-1	Time : 2011/06/18 - 00:47
Limit : CISPR_B_10M_QP	Margin : 6
EUT : Network Camera	Probe : Site1_CBL6112_10M_0811 - VERTICAL
Power : AC 230V/50Hz to AC 24V	Note : Mode 2

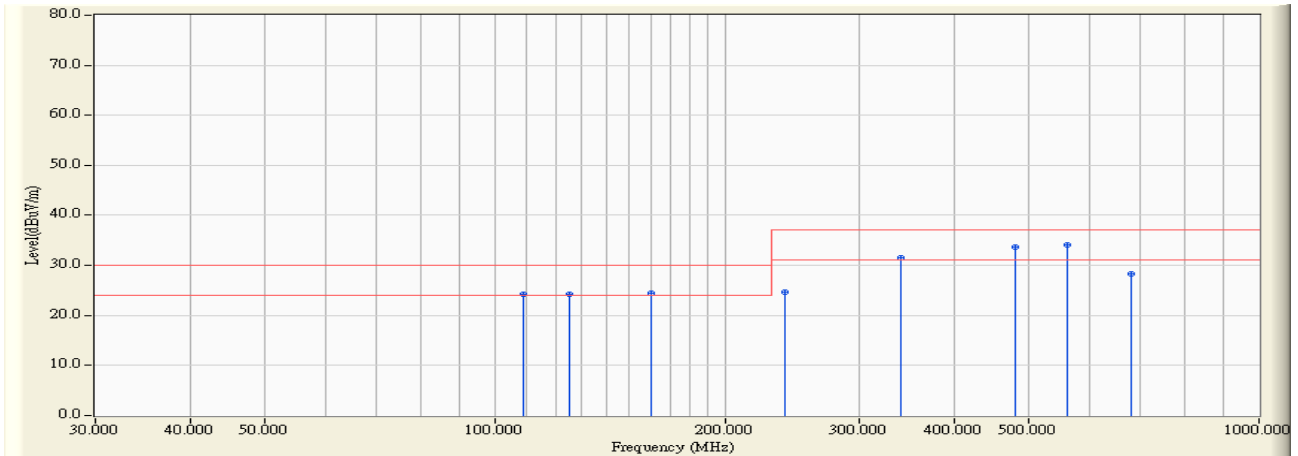

		Frequency (MHz)	Correct Factor (dB)	Reading Level (dBuV)	Measure Level (dBuV/m)	Margin (dB)	Limit (dBuV/m)	Detector Type
1		108.770	12.939	11.200	24.139	-5.861	30.000	QUASPEAK
2		125.000	13.570	10.600	24.170	-5.830	30.000	QUASPEAK
3		160.000	11.519	13.000	24.518	-5.482	30.000	QUASPEAK
4		240.000	13.300	11.300	24.600	-12.400	37.000	QUASPEAK
5		339.990	17.009	14.600	31.608	-5.392	37.000	QUASPEAK
6		480.000	20.693	12.900	33.593	-3.407	37.000	QUASPEAK
7	*	560.000	22.500	11.500	34.000	-3.000	37.000	QUASPEAK
8		679.980	23.100	5.300	28.400	-8.600	37.000	QUASPEAK

Note:

1. All Readings below 1GHz are Quasi-Peak, above are performed with peak and/or average measurements as necessary.
2. " * ", means this data is the worst emission level.
3. Measurement Level = Reading Level + Correct Factor

Site : OATS-1	Time : 2011/06/18 - 01:33
Limit : CISPR_B_10M_QP	Margin : 6
EUT : Network Camera	Probe : Site1_CBL6112_10M_0811 - HORIZONTAL
Power : POE	Note : Mode 3

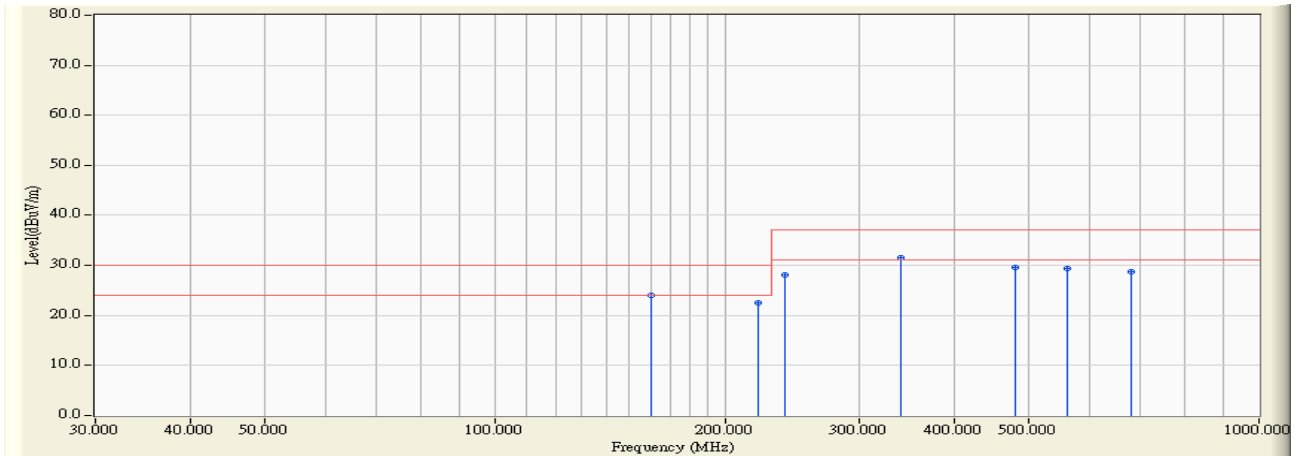

		Frequency (MHz)	Correct Factor (dB)	Reading Level (dBuV)	Measure Level (dBuV/m)	Margin (dB)	Limit (dBuV/m)	Detector Type
1		160.000	11.519	12.400	23.918	-6.082	30.000	QUASIPeAK
2		221.200	11.046	11.400	22.446	-7.554	30.000	QUASIPeAK
3		240.000	13.300	14.800	28.100	-8.900	37.000	QUASIPeAK
4	*	339.990	17.009	14.600	31.608	-5.392	37.000	QUASIPeAK
5		480.000	20.693	8.900	29.593	-7.407	37.000	QUASIPeAK
6		560.000	22.500	6.800	29.300	-7.700	37.000	QUASIPeAK
7		679.990	23.100	5.600	28.700	-8.300	37.000	QUASIPeAK

Note:

1. All Readings below 1GHz are Quasi-Peak, above are performed with peak and/or average measurements as necessary.
2. " * ", means this data is the worst emission level.
3. Measurement Level = Reading Level + Correct Factor

Site : OATS-1	Time : 2011/06/18 - 01:21
Limit : CISPR_B_10M_QP	Margin : 6
EUT : Network Camera	Probe : Site1_CBL6112_10M_0811 - VERTICAL
Power : POE	Note : Mode 3

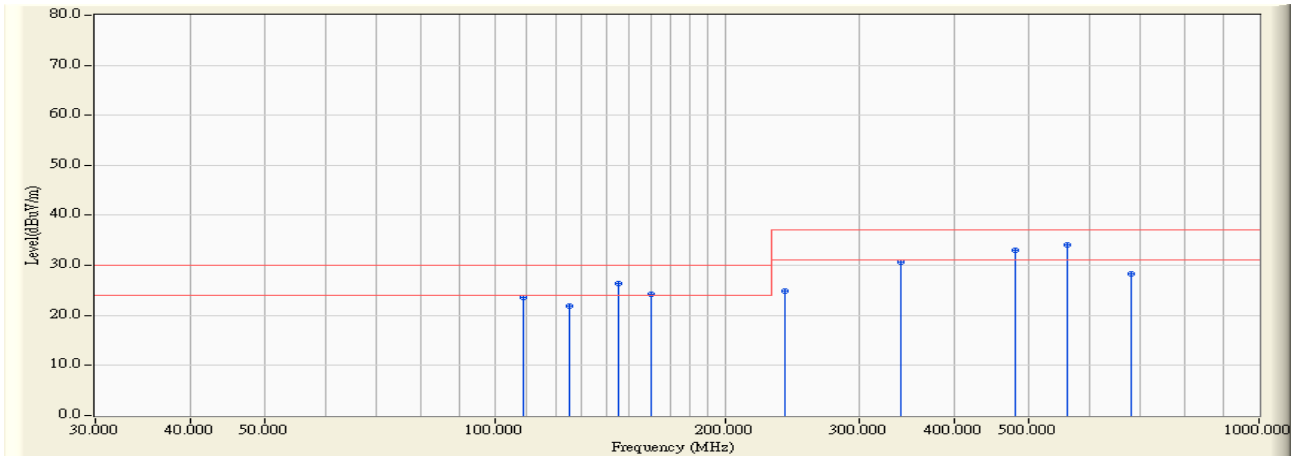

		Frequency (MHz)	Correct Factor (dB)	Reading Level (dBuV)	Measure Level (dBuV/m)	Margin (dB)	Limit (dBuV/m)	Detector Type
1		108.770	12.939	10.700	23.639	-6.361	30.000	QUASIPeAK
2		125.000	13.570	8.200	21.770	-8.230	30.000	QUASIPeAK
3		145.260	12.391	13.900	26.290	-3.710	30.000	QUASIPeAK
4		160.000	11.519	12.800	24.318	-5.682	30.000	QUASIPeAK
5		240.000	13.300	11.600	24.900	-12.100	37.000	QUASIPeAK
6		339.990	17.009	13.600	30.608	-6.392	37.000	QUASIPeAK
7		480.000	20.693	12.300	32.993	-4.007	37.000	QUASIPeAK
8	*	560.000	22.500	11.500	34.000	-3.000	37.000	QUASIPeAK
9		679.990	23.100	5.300	28.400	-8.600	37.000	QUASIPeAK

Note:

1. All Readings below 1GHz are Quasi-Peak, above are performed with peak and/or average measurements as necessary.
2. " * ", means this data is the worst emission level.
3. Measurement Level = Reading Level + Correct Factor

Site: 9x6x6_Chamber	Time: 2011/06/18 - 03:53
Limit: EN55022_B_(Above_1G)	Margin: 0
Probe: 9120D_1-18G_Horn	Polarity: Horizontal
EUT: Network Camera	Power : AC 230V/50Hz to DC 12V
Note: Mode 1	

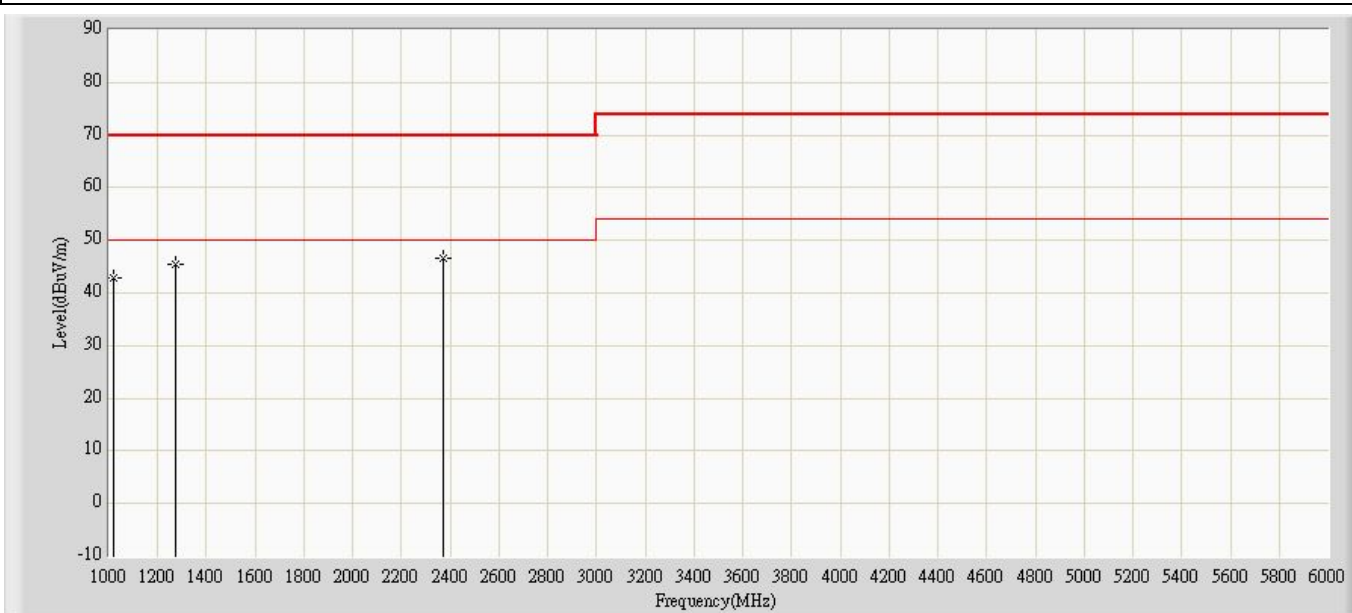

No	Flag	Mark	Frequency (MHz)	Measure Level (dBuV/m)	Reading Level (dBuV)	Over Limit (dB)	Limit (dBuV/m)	Factor	Type
1			1020.000	42.974	51.210	-27.026	70.000	-8.236	PK
2			1270.000	45.534	53.000	-24.466	70.000	-7.466	PK
3		*	2372.000	46.575	51.380	-23.425	70.000	-4.805	PK

Note:

1. All Readings below 1GHz are Quasi-Peak, above are performed with peak and/or average measurements as necessary.
2. " * ", means this data is the worst emission level.
3. Measurement Level = Reading Level + Factor(Probe+Cable-Amp).

Site: 9x6x6_Chamber	Time: 2011/06/18 - 04:03
Limit: EN55022_B_(Above_1G)	Margin: 0
Probe: 9120D_1-18G_Horn	Polarity: Vertical
EUT: Network Camera	Power : AC 230V/50Hz to DC 12V
Note: Mode 1	

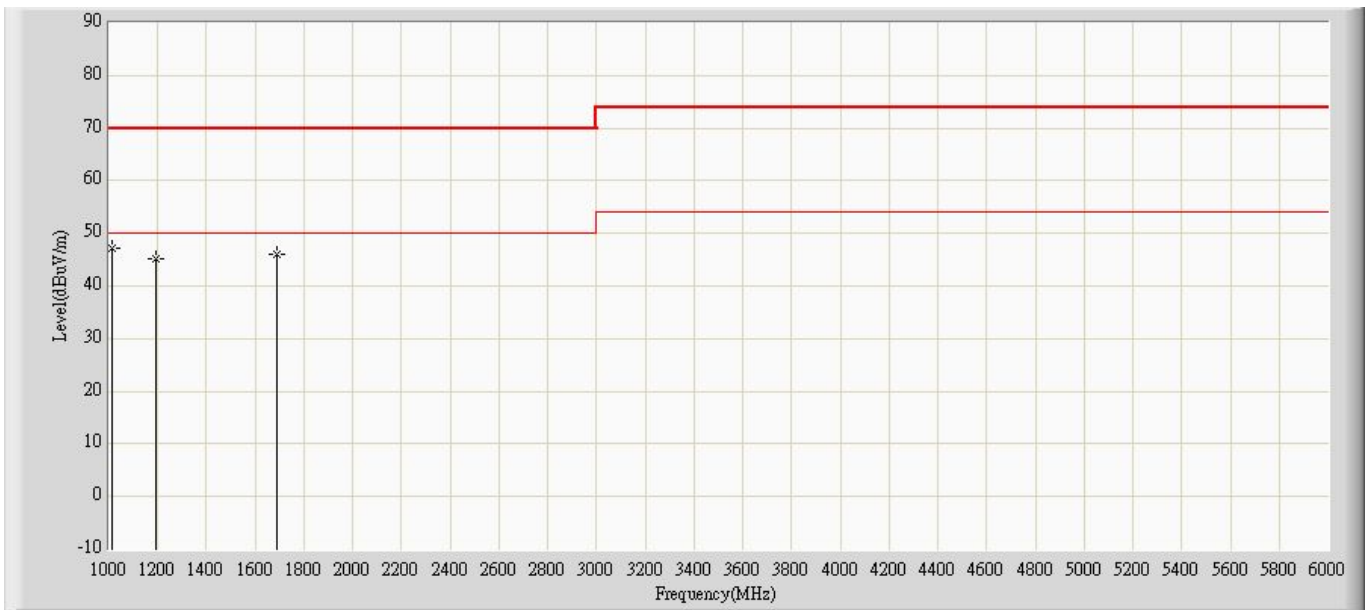

No	Flag	Mark	Frequency (MHz)	Measure Level (dBuV/m)	Reading Level (dBuV)	Over Limit (dB)	Limit (dBuV/m)	Factor	Type
1		*	1010.000	47.132	55.380	-22.868	70.000	-8.248	PK
2			1190.000	45.293	53.130	-24.707	70.000	-7.837	PK
3			1691.000	45.911	52.440	-24.089	70.000	-6.529	PK

Note:

1. All Readings below 1GHz are Quasi-Peak, above are performed with peak and/or average measurements as necessary.
2. " * ", means this data is the worst emission level.
3. Measurement Level = Reading Level + Factor(Probe+Cable-Amp).

Site: 9x6x6_Chamber	Time: 2011/06/18 - 03:49
Limit: EN55022_B_(Above_1G)	Margin: 0
Probe: 9120D_1-18G_Horn	Polarity: Horizontal
EUT: Network Camera	Power: AC 230V/50Hz to AC 24V
Note: Mode 2	

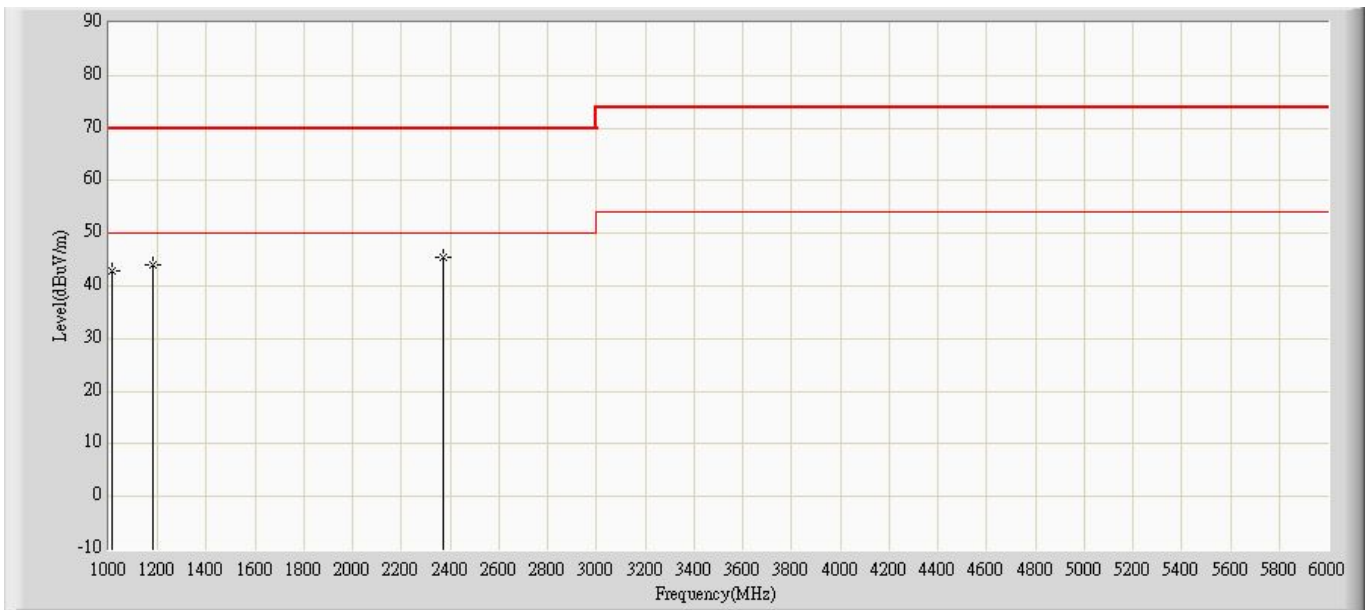

No	Flag	Mark	Frequency (MHz)	Measure Level (dBuV/m)	Reading Level (dBuV)	Over Limit (dB)	Limit (dBuV/m)	Factor	Type
1			1010.000	42.752	51.000	-27.248	70.000	-8.248	PK
2			1180.000	44.090	51.910	-25.910	70.000	-7.820	PK
3		*	2372.000	45.375	50.180	-24.625	70.000	-4.805	PK

Note:

1. All Readings below 1GHz are Quasi-Peak, above are performed with peak and/or average measurements as necessary.
2. " * ", means this data is the worst emission level.
3. Measurement Level = Reading Level + Factor(Probe+Cable-Amp).

Site: 9x6x6_Chamber	Time: 2011/06/18 - 03:41
Limit: EN55022_B_(Above_1G)	Margin: 0
Probe: 9120D_1-18G_Horn	Polarity: Vertical
EUT: Network Camera	Power: AC 230V/50Hz to AC 24V
Note: Mode 2	

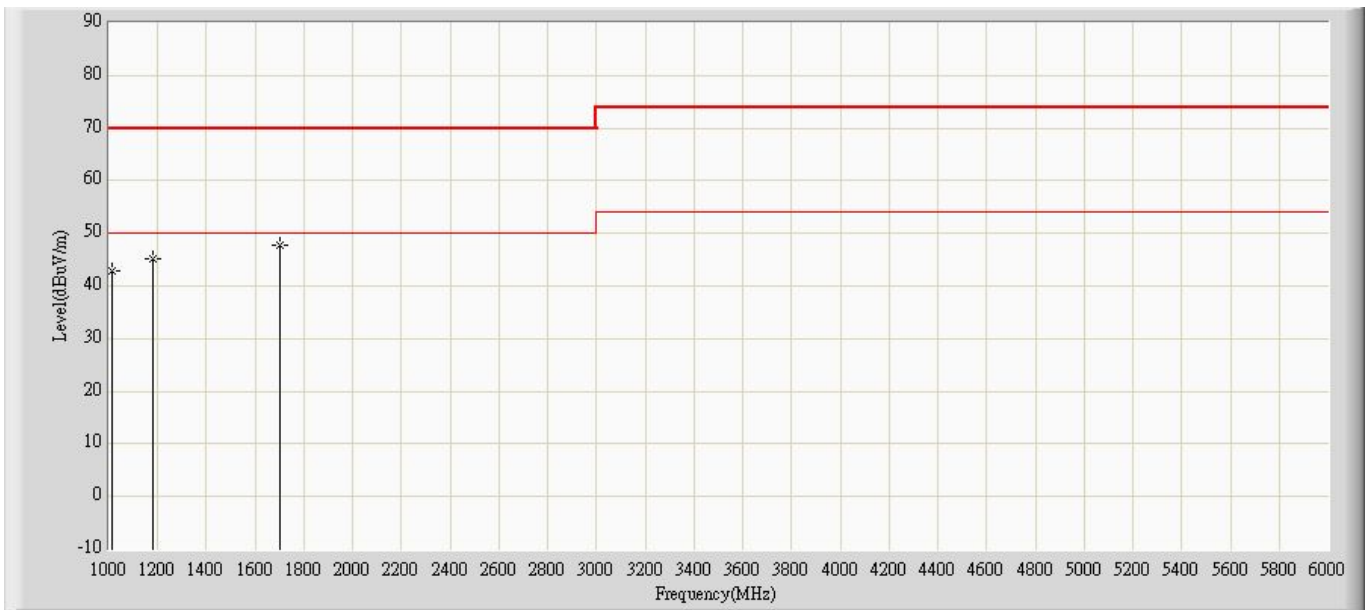

No	Flag	Mark	Frequency (MHz)	Measure Level (dBuV/m)	Reading Level (dBuV)	Over Limit (dB)	Limit (dBuV/m)	Factor	Type
1			1010.000	42.922	51.170	-27.078	70.000	-8.248	PK
2			1180.000	45.180	53.000	-24.820	70.000	-7.820	PK
3		*	1701.000	47.695	54.220	-22.305	70.000	-6.525	PK

Note:

1. All Readings below 1GHz are Quasi-Peak, above are performed with peak and/or average measurements as necessary.
2. " * ", means this data is the worst emission level.
3. Measurement Level = Reading Level + Factor(Probe+Cable-Amp).

Site: 9x6x6_Chamber	Time: 2011/06/18 - 03:32
Limit: EN55022_B_(Above_1G)	Margin: 0
Probe: 9120D_1-18G_Horn	Polarity: Horizontal
EUT: Network Camera	Power: POE
Note: Mode 3	

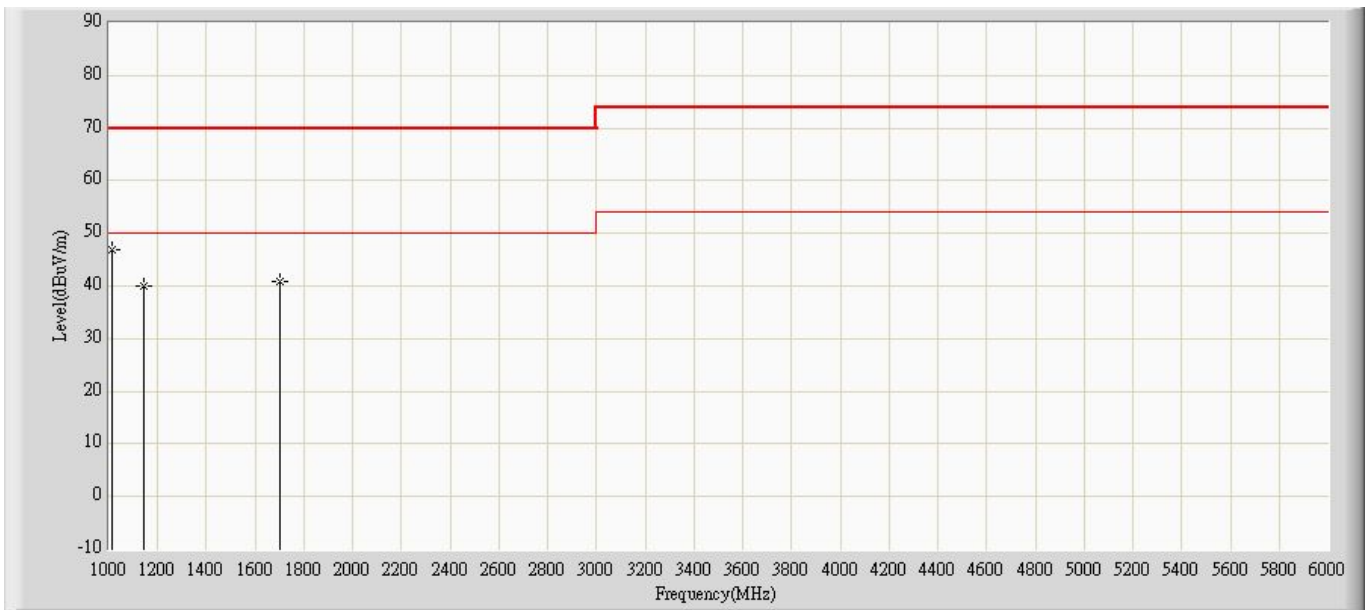

No	Flag	Mark	Frequency (MHz)	Measure Level (dBuV/m)	Reading Level (dBuV)	Over Limit (dB)	Limit (dBuV/m)	Factor	Type
1		*	1010.000	46.882	55.130	-23.118	70.000	-8.248	PK
2			1140.000	40.076	47.980	-29.924	70.000	-7.904	PK
3			1701.000	40.945	47.470	-29.055	70.000	-6.525	PK

Note:

1. All Readings below 1GHz are Quasi-Peak, above are performed with peak and/or average measurements as necessary.
2. " * ", means this data is the worst emission level.
3. Measurement Level = Reading Level + Factor(Probe+Cable-Amp).

Site: 9x6x6_Chamber	Time: 2011/06/18 - 03:35
Limit: EN55022_B_(Above_1G)	Margin: 0
Probe: 9120D_1-18G_Horn	Polarity: Vertical
EUT: Network Camera	Power: POE
Note: Mode 3	

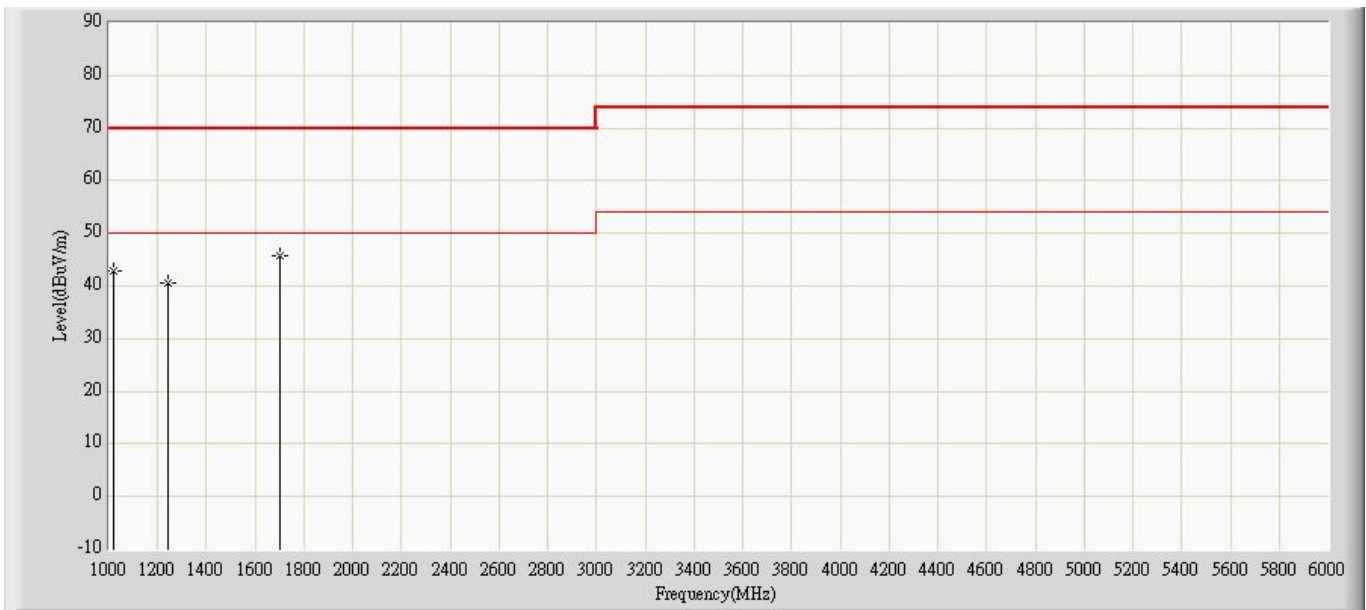

No	Flag	Mark	Frequency (MHz)	Measure Level (dBuV/m)	Reading Level (dBuV)	Over Limit (dB)	Limit (dBuV/m)	Factor	Type
1			1020.000	42.764	51.000	-27.236	70.000	-8.236	PK
2			1240.000	40.464	48.120	-29.536	70.000	-7.655	PK
3		*	1701.000	45.745	52.270	-24.255	70.000	-6.525	PK

Note:

1. All Readings below 1GHz are Quasi-Peak, above are performed with peak and/or average measurements as necessary.
2. " * ", means this data is the worst emission level.
3. Measurement Level = Reading Level + Factor(Probe+Cable-Amp).

5.7. Test Photograph

Test Mode : Mode 1: Normal Operation, Adapter : 3A-183WP12

Description : Front View of Radiated Test



Test Mode : Mode 1: Normal Operation, Adapter : 3A-183WP12

Description : Back View of Radiated Test

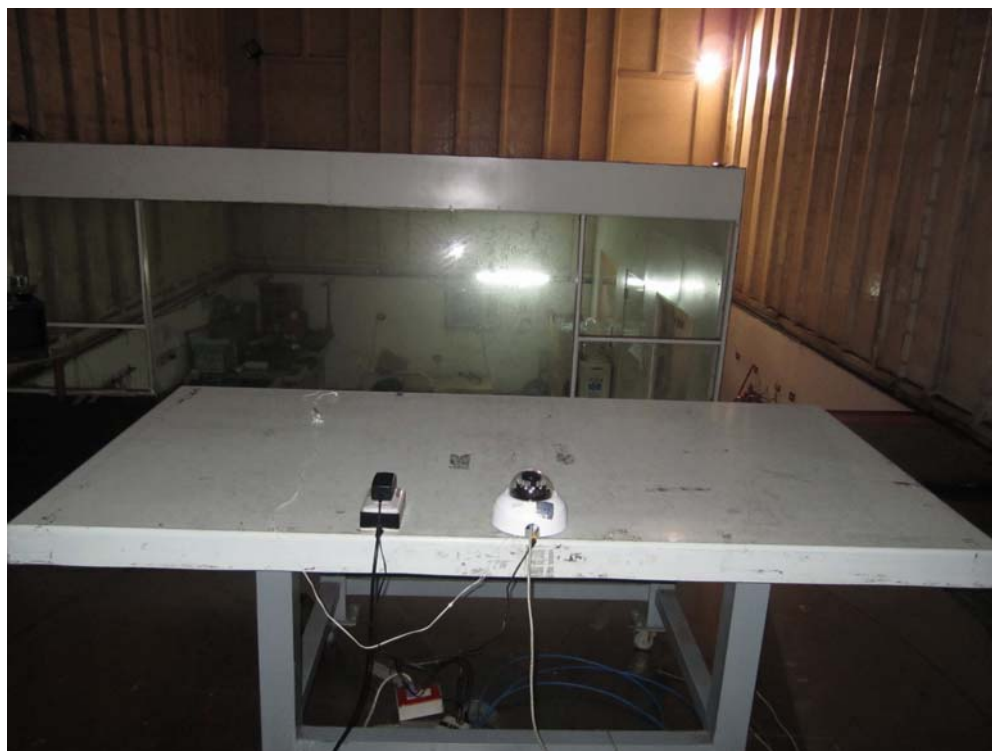

Test Mode : Mode 1: Normal Operation, Adapter : 3A-183WP12

Description : Front View of High Frequency Radiated Test



Test Mode : Mode 2: Normal Operation, Adapter : DE-60-24W

Description : Front View of Radiated Test



Test Mode : Mode 2: Normal Operation, Adapter : DE-60-24W

Description : Back View of Radiated Test

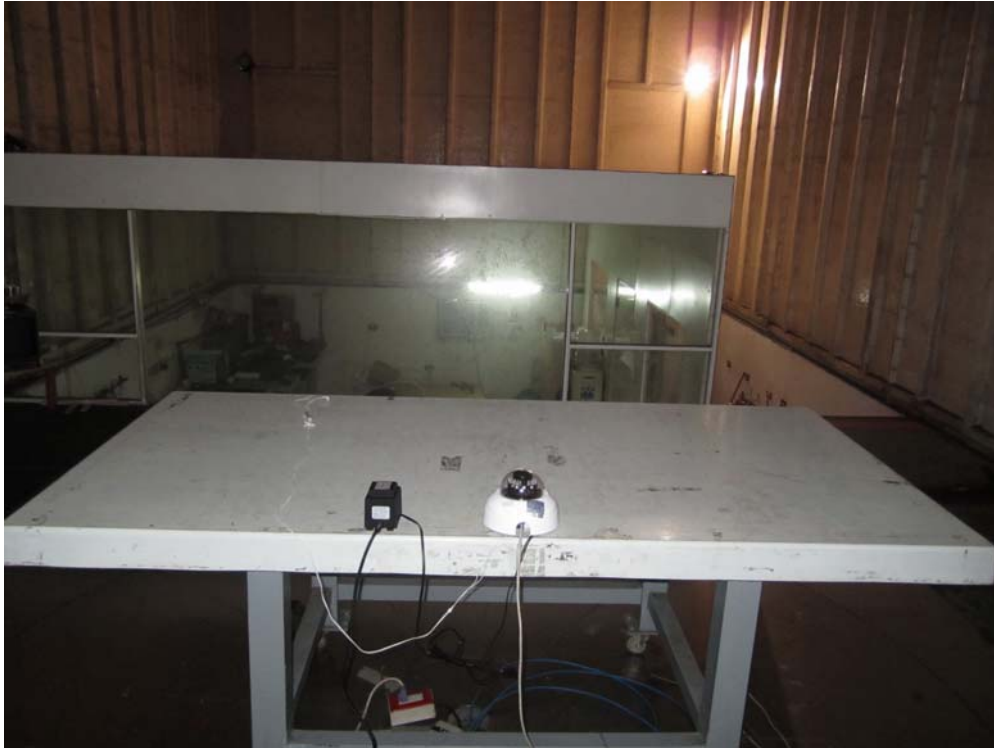

Test Mode : Mode 2: Normal Operation, Adapter : DE-60-24W

Description : Front View of High Frequency Radiated Test

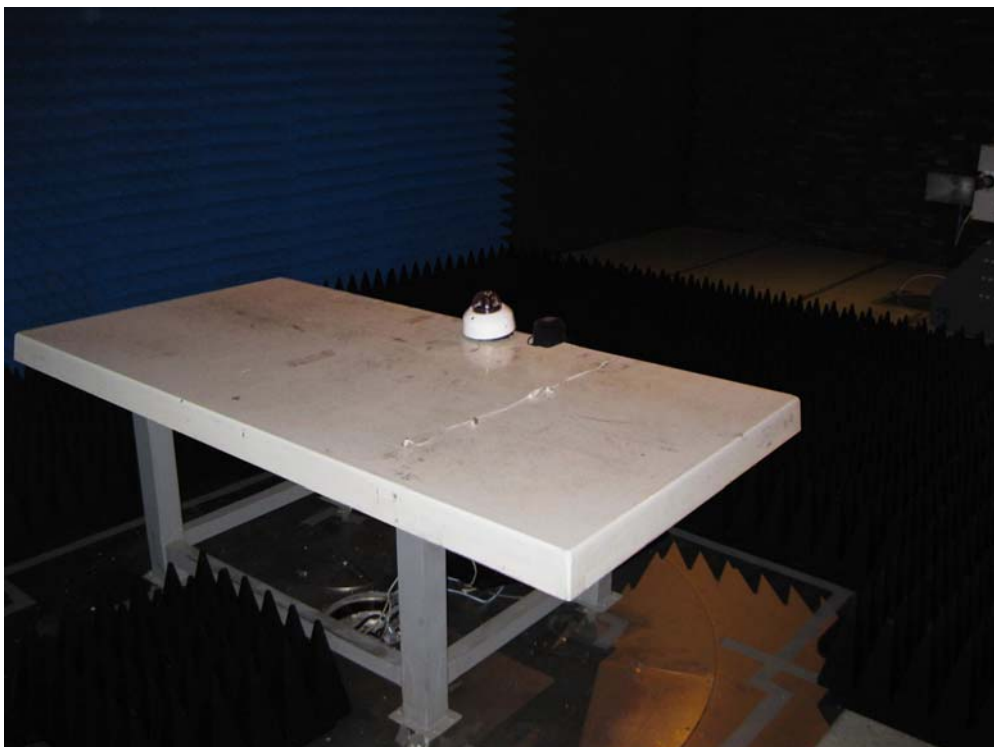

Test Mode : Mode 3: Normal Operation, PoE

Description : Front View of Radiated Test



Test Mode : Mode 3: Normal Operation, PoE

Description : Back View of Radiated Test



Test Mode : Mode 3: Normal Operation, PoE

Description : Front View of High Frequency Radiated Test



6. Harmonic Current Emission

6.1. Test Specification

According to EMC Standard : EN 61000-3-2

6.2. Test Setup

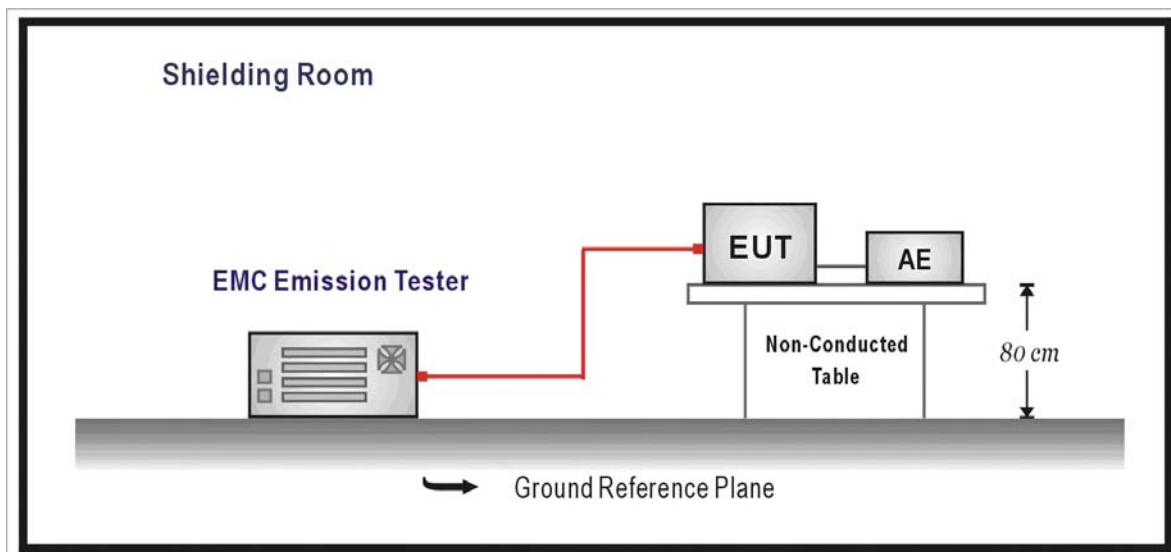

6.3. Limit

(a) Limits of Class A Harmonics Currents

Harmonics Order n	Maximum Permissible harmonic current A	Harmonics Order n	Maximum Permissible harmonic current A
Odd harmonics		Even harmonics	
3	2.30	2	1.08
5	1.14	4	0.43
7	0.77	6	0.30
9	0.40	8 ≤ n ≤ 40	0.23 * 8/n
11	0.33		
13	0.21		
15 ≤ n ≤ 39	0.15 * 15/n		

(b) Limits of Class B Harmonics Currents

For Class B equipment, the harmonic of the input current shall not exceed the maximum permissible values given in table that is the limit of Class A multiplied by a factor of 1.5.

(c) Limits of Class C Harmonics Currents

Harmonics Order n	Maximum Permissible harmonic current Expressed as a percentage of the input current at the fundamental frequency %
2	2
3	$30 \cdot \lambda^*$
5	10
7	7
9	5
$11 \leq n \leq 39$ (odd harmonics only)	3
* λ is the circuit power factor	

(d) Limits of Class D Harmonics Currents

Harmonics Order n	Maximum Permissible harmonic current per watt mA/W	Maximum Permissible harmonic current A
3	3.4	2.30
5	1.9	1.14
7	1.0	0.77
9	0.5	0.40
11	0.35	0.33
$11 \leq n \leq 39$ (odd harmonics only)	$3.85/n$	See limit of Class A

6.4. Test Procedure

The EUT is supplied in series with power analyzer from a power source having the same normal voltage and frequency as the rated supply voltage and the equipment under test. And the rated voltage at the supply voltage of EUT of 0.94 times and 1.06 times shall be performed.

6.5. Deviation from Test Standard

No deviation.

6.6. Test Result

Product	Network Camera		
Test Item	Power Harmonics		
Test Mode	Mode 1: Normal Operation, Adapter : 3A-183WP12		
Date of Test	2011/06/24	Test Site	No.3 Shielded Room

Test Result: Pass Source qualification: Normal

Current & voltage waveforms

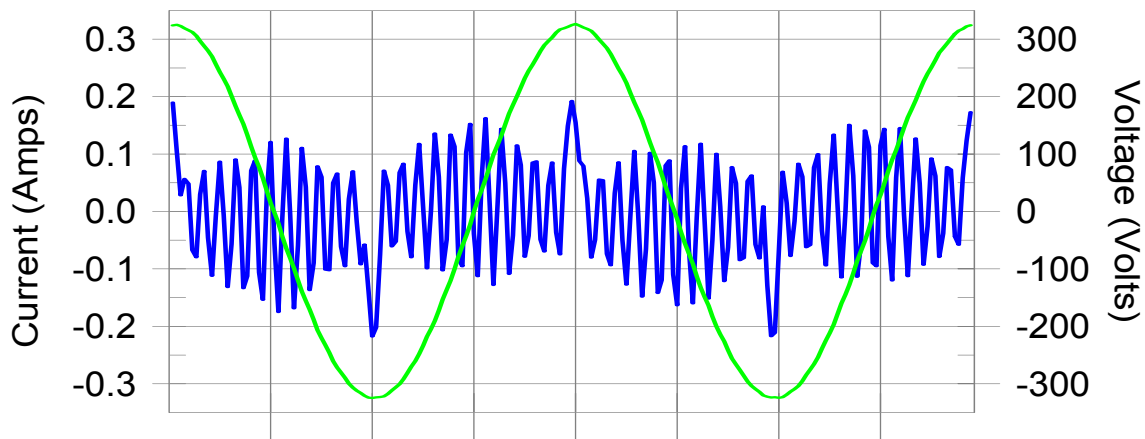

Harmonics and Class A limit line

European Limits

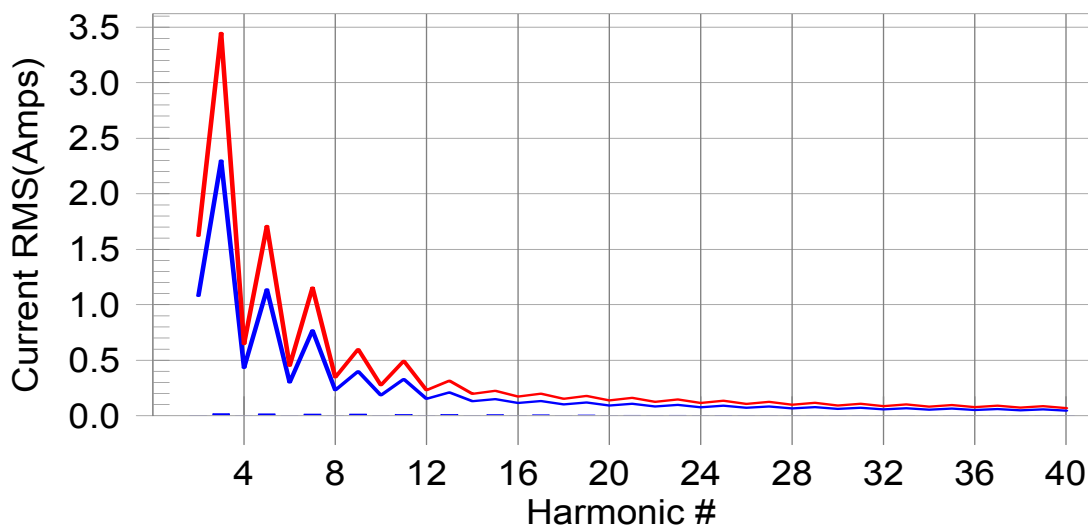

Test result: Pass Worst harmonic was #15 with 6.58% of the limit.

Test Result: Pass Source qualification: Normal
 THC(A): 0.04 I-THD(%): 166.16 POHC(A): 0.007 POHC Limit(A): 0.251
 Highest parameter values during test:

V_RMS (Volts):	229.60	Frequency(Hz):	50.00
I_Peak (Amps):	0.288	I_RMS (Amps):	0.095
I_Fund (Amps):	0.025	Crest Factor:	3.045
Power (Watts):	4.3	Power Factor:	0.198

Harm#	Harms(avg)	100%Limit	%of Limit	Harms(max)	150%Limit	%of Limit	Status
2	0.000	1.080	0.0	0.000	1.620	0.03	Pass
3	0.018	2.300	0.8	0.018	3.450	0.53	Pass
4	0.000	0.430	0.1	0.000	0.645	0.07	Pass
5	0.017	1.140	1.5	0.017	1.710	1.02	Pass
6	0.000	0.300	0.1	0.001	0.450	0.12	Pass
7	0.016	0.770	2.1	0.016	1.155	1.41	Pass
8	0.000	0.230	0.1	0.000	0.345	0.12	Pass
9	0.015	0.400	3.7	0.015	0.600	2.49	Pass
10	0.000	0.184	0.1	0.000	0.276	0.15	Pass
11	0.013	0.330	4.0	0.013	0.495	2.71	Pass
12	0.000	0.153	0.2	0.000	0.230	0.18	Pass
13	0.012	0.210	5.5	0.012	0.315	3.73	Pass
14	0.000	0.131	0.2	0.000	0.197	0.16	Pass
15	0.010	0.150	6.6	0.010	0.225	4.44	Pass
16	0.000	0.115	0.2	0.000	0.173	0.16	Pass
17	0.008	0.132	6.2	0.008	0.199	4.16	Pass
18	0.000	0.102	0.2	0.000	0.153	0.19	Pass
19	0.006	0.118	5.5	0.007	0.178	3.70	Pass
20	0.000	0.092	0.2	0.000	0.138	0.16	Pass
21	0.005	0.107	4.6	0.005	0.161	3.14	Pass
22	0.000	0.084	0.2	0.000	0.125	0.17	Pass
23	0.004	0.098	3.7	0.004	0.147	2.52	Pass
24	0.000	0.077	0.2	0.000	0.115	0.17	Pass
25	0.002	0.090	2.7	0.002	0.135	1.85	Pass
26	0.000	0.071	0.2	0.000	0.106	0.20	Pass
27	0.001	0.083	1.8	0.002	0.125	1.23	Pass
28	0.000	0.066	0.2	0.000	0.099	0.23	Pass
29	0.001	0.078	0.9	0.001	0.116	0.70	Pass
30	0.000	0.061	0.4	0.000	0.092	0.42	Pass
31	0.000	0.073	0.4	0.000	0.109	0.36	Pass
32	0.000	0.058	0.3	0.000	0.086	0.26	Pass
33	0.000	0.068	0.6	0.000	0.102	0.45	Pass
34	0.000	0.054	0.3	0.000	0.081	0.29	Pass
35	0.001	0.064	0.9	0.001	0.096	0.63	Pass
36	0.000	0.051	0.3	0.000	0.077	0.30	Pass
37	0.001	0.061	1.1	0.001	0.091	0.77	Pass
38	0.000	0.048	0.4	0.000	0.073	0.36	Pass
39	0.001	0.058	1.1	0.001	0.087	0.81	Pass
40	0.000	0.046	0.4	0.000	0.069	0.38	Pass

1.Dynamic limits were applied for this test. The highest harmonics values in the above table may not occur at the same window as the maximum harmonics/limit ratio.

2:According to EN61000-3-2 paragraph 7 the note 1 and 2 are valid for all applications having an active input power >75W. Others the result should be pass.

Product	Network Camera		
Test Item	Power Harmonics		
Test Mode	Mode 2: Normal Operation, Adapter : DE-60-24W		
Date of Test	2011/06/24	Test Site	No.3 Shielded Room

Test Result: Pass Source qualification: Normal

Current & voltage waveforms

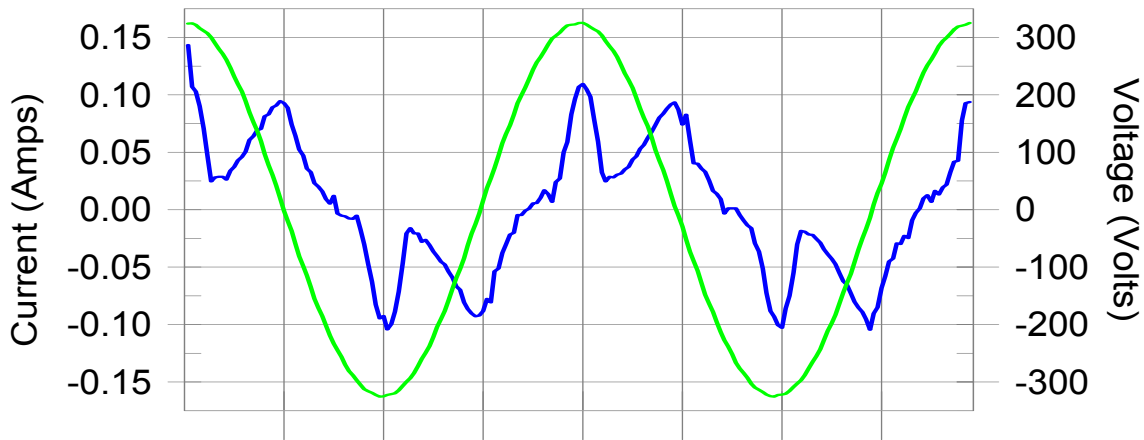

Harmonics and Class A limit line

European Limits

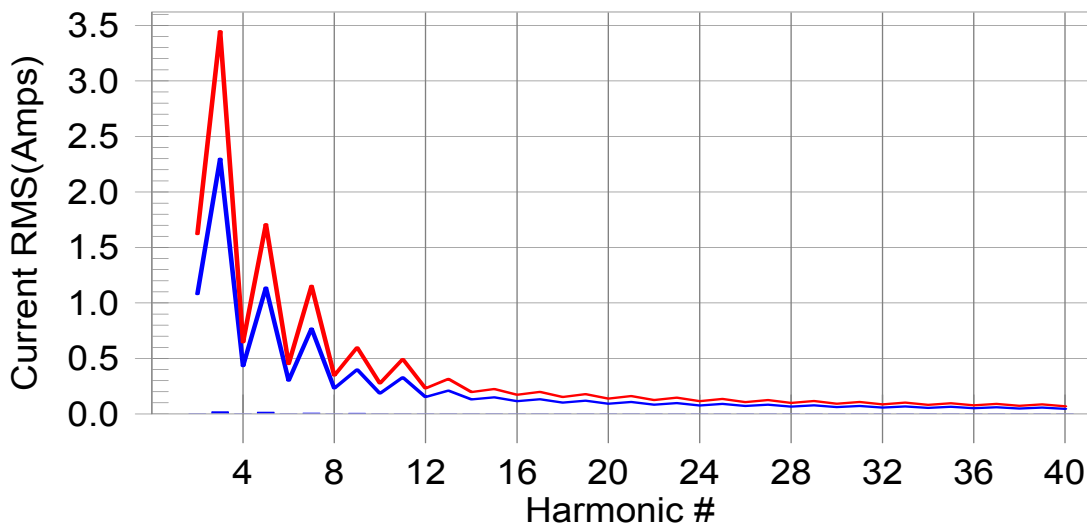

Test result: Pass Worst harmonic was #9 with 1.59% of the limit.

Test Result: Pass Source qualification: Normal
 THC(A): 0.03 I-THD(%): 53.20 POHC(A): 0.001 POHC Limit(A): 0.251
 Highest parameter values during test:

V_RMS (Volts):	229.62	Frequency(Hz):	50.00
I_Peak (Amps):	0.143	I_RMS (Amps):	0.059
I_Fund (Amps):	0.052	Crest Factor:	2.462
Power (Watts):	7.8	Power Factor:	0.578

Harm#	Harms(avg)	100%Limit	%of Limit	Harms(max)	150%Limit	%of Limit	Status
2	0.001	1.080	0.1	0.001	1.620	0.06	Pass
3	0.019	2.300	0.8	0.019	3.450	0.55	Pass
4	0.001	0.430	0.1	0.001	0.645	0.10	Pass
5	0.017	1.140	1.5	0.017	1.710	0.99	Pass
6	0.000	0.300	0.1	0.000	0.450	0.10	Pass
7	0.008	0.770	1.0	0.008	1.155	0.68	Pass
8	0.000	0.230	0.1	0.000	0.345	0.10	Pass
9	0.006	0.400	1.6	0.007	0.600	1.08	Pass
10	0.000	0.184	0.1	0.000	0.276	0.07	Pass
11	0.002	0.330	0.5	0.002	0.495	0.35	Pass
12	0.000	0.153	0.1	0.000	0.230	0.08	Pass
13	0.001	0.210	0.5	0.001	0.315	0.35	Pass
14	0.000	0.131	0.1	0.000	0.197	0.09	Pass
15	0.001	0.150	0.7	0.001	0.225	0.47	Pass
16	0.000	0.115	0.1	0.000	0.173	0.11	Pass
17	0.001	0.132	0.8	0.001	0.199	0.56	Pass
18	0.000	0.102	0.1	0.000	0.153	0.10	Pass
19	0.001	0.118	0.5	0.001	0.178	0.39	Pass
20	0.000	0.092	0.1	0.000	0.138	0.12	Pass
21	0.000	0.107	0.4	0.000	0.161	0.28	Pass
22	0.000	0.084	0.1	0.000	0.125	0.13	Pass
23	0.001	0.098	0.5	0.001	0.147	0.39	Pass
24	0.000	0.077	0.1	0.000	0.115	0.14	Pass
25	0.000	0.090	0.4	0.000	0.135	0.32	Pass
26	0.000	0.071	0.2	0.000	0.106	0.16	Pass
27	0.000	0.083	0.4	0.000	0.125	0.30	Pass
28	0.000	0.066	0.2	0.000	0.099	0.17	Pass
29	0.000	0.078	0.3	0.000	0.116	0.25	Pass
30	0.000	0.061	0.2	0.000	0.092	0.16	Pass
31	0.000	0.073	0.4	0.000	0.109	0.32	Pass
32	0.000	0.058	0.2	0.000	0.086	0.19	Pass
33	0.000	0.068	0.4	0.000	0.102	0.32	Pass
34	0.000	0.054	0.2	0.000	0.081	0.19	Pass
35	0.000	0.064	0.3	0.000	0.096	0.30	Pass
36	0.000	0.051	0.2	0.000	0.077	0.23	Pass
37	0.000	0.061	0.3	0.000	0.091	0.30	Pass
38	0.000	0.048	0.3	0.000	0.073	0.25	Pass
39	0.000	0.058	0.4	0.000	0.087	0.32	Pass
40	0.000	0.046	0.3	0.000	0.069	0.25	Pass

1.Dynamic limits were applied for this test. The highest harmonics values in the above table may not occur at the same window as the maximum harmonics/limit ratio.

2:According to EN61000-3-2 paragraph 7 the note 1 and 2 are valid for all applications having an active input power >75W. Others the result should be pass.

6.7. Test Photograph

Test Mode : Mode 1: Normal Operation, Adapter : 3A-183WP12

Description : Power Harmonics Test Setup



Test Mode : Mode 2: Normal Operation, Adapter : DE-60-24W

Description : Power Harmonics Test Setup



7. Voltage Fluctuation and Flicker

7.1. Test Specification

According to EMC Standard : EN 61000-3-3

7.2. Test Setup

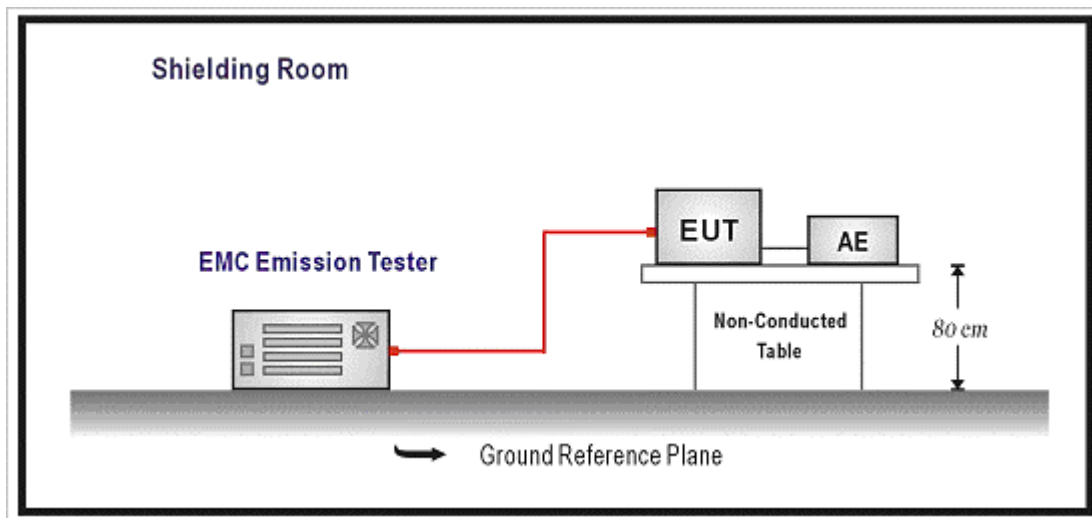

7.3. Limit

The following limits apply:

- the value of P_{st} shall not be greater than 1.0;
 - the value of P_{1t} shall not be greater than 0.65;
 - the value of $d(t)$ during a voltage change shall not exceed 3.3 % for more than 500 ms;
 - the relative steady-state voltage change, d_c , shall not exceed 3.3 %;
 - the maximum relative voltage change, d_{max} , shall not exceed;
- a) 4 % without additional conditions;
 - b) 6 % for equipment which is:
 - switched manually, or
 - switched automatically more frequently than twice per day, and also has either a delayed restart (the delay being not less than a few tens of seconds), or manual restart, after a power supply interruption.

NOTE The cycling frequency will be further limited by the P_{st} and P_{1t} limit.

For example: a d_{max} of 6% producing a rectangular voltage change characteristic twice per hour will give a P_{1t} of about 0.65.

- c) 7 % for equipment which is:
- attended whilst in use (for example: hair dryers, vacuum cleaners, kitchen equipment such as mixers, garden equipment such as lawn mowers, portable tools such as electric drills), or
 - switched on automatically, or is intended to be switched on manually, no more than twice per day, and also has either a delayed restart (the delay being not less than a few tens of seconds) or manual restart, after a power supply interruption.

P_{st} and P_{1t} requirements shall not be applied to voltage changes caused by manual switching.

7.4. Test Procedure

The EUT is supplied in series with power analyzer from a power source having the same normal voltage and frequency as the rated supply voltage and the equipment under test. And the rated voltage at the supply voltage of EUT of 0.94 times and 1.06 times shall be performed.

7.5. Deviation from Test Standard

No deviation.

7.6. Test Result

Product	Network Camera		
Test Item	Voltage Fluctuation and Flicker		
Test Mode	Mode 1: Normal Operation, Adapter : 3A-183WP12		
Date of Test	2011/06/24	Test Site	No.3 Shielded Room

Test Result: Pass

Status: Test Completed

Pstj and limit line

European Limits

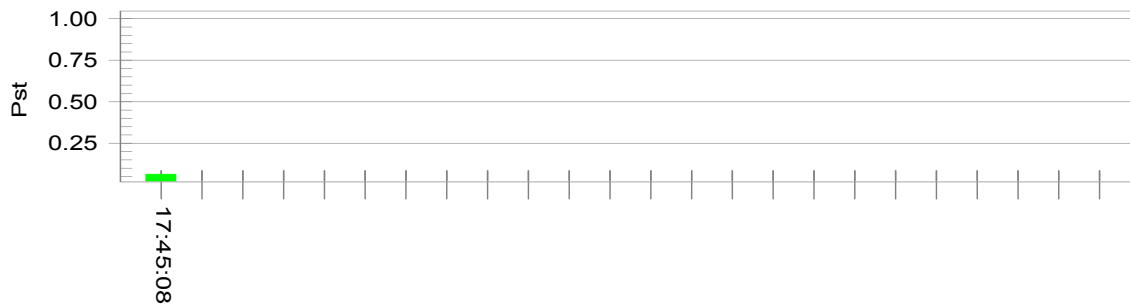

Plt and limit line



Parameter values recorded during the test:

Vrms at the end of test (Volt):	229.54			
Highest dt (%):	0.00	Test limit (%):	3.30	Pass
Time(mS) > dt:	0.0	Test limit (mS):	500.0	Pass
Highest dc (%):	0.00	Test limit (%):	3.30	Pass
Highest dmax (%):	0.00	Test limit (%):	4.00	Pass
Highest Pst (10 min. period):	0.064	Test limit:	1.000	Pass
Highest Plt (2 hr. period):	0.028	Test limit:	0.650	Pass

Product	Network Camera		
Test Item	Voltage Fluctuation and Flicker		
Test Mode	Mode 2: Normal Operation, Adapter : DE-60-24W		
Date of Test	2011/06/24	Test Site	No.3 Shielded Room

Test Result: Pass

Status: Test Completed

Pstj and limit line

European Limits

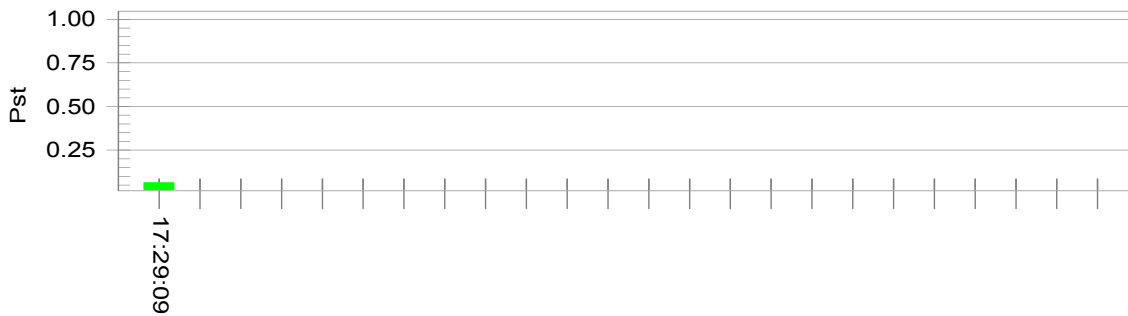

Plt and limit line

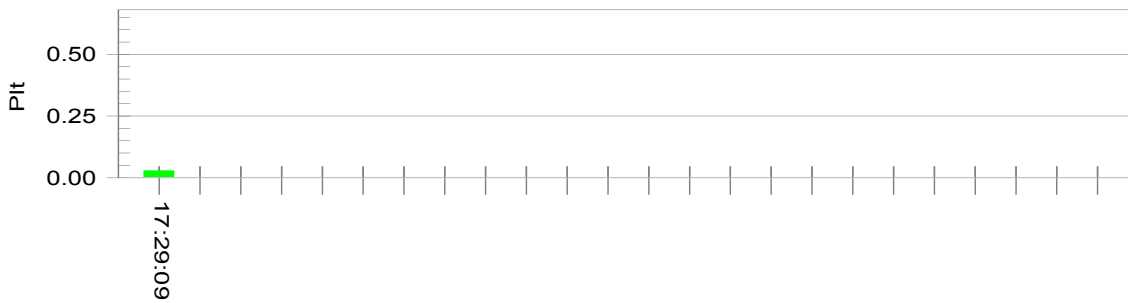

Parameter values recorded during the test:

Vrms at the end of test (Volt):	229.50		
Highest dt (%):	0.00	Test limit (%):	3.30 Pass
Time(mS) > dt:	0.0	Test limit (mS):	500.0 Pass
Highest dc (%):	0.00	Test limit (%):	3.30 Pass
Highest dmax (%):	0.00	Test limit (%):	4.00 Pass
Highest Pst (10 min. period):	0.064	Test limit:	1.000 Pass
Highest Plt (2 hr. period):	0.028	Test limit:	0.650 Pass

7.7. Test Photograph

Test Mode : Mode 1: Normal Operation, Adapter : 3A-183WP12

Description : Flicker Test Setup



Test Mode : Mode 2: Normal Operation, Adapter : DE-60-24W

Description : Flicker Test Setup



8. Electrostatic Discharge

8.1. Test Specification

According to Standard : IEC 61000-4-2

8.2. Test Setup

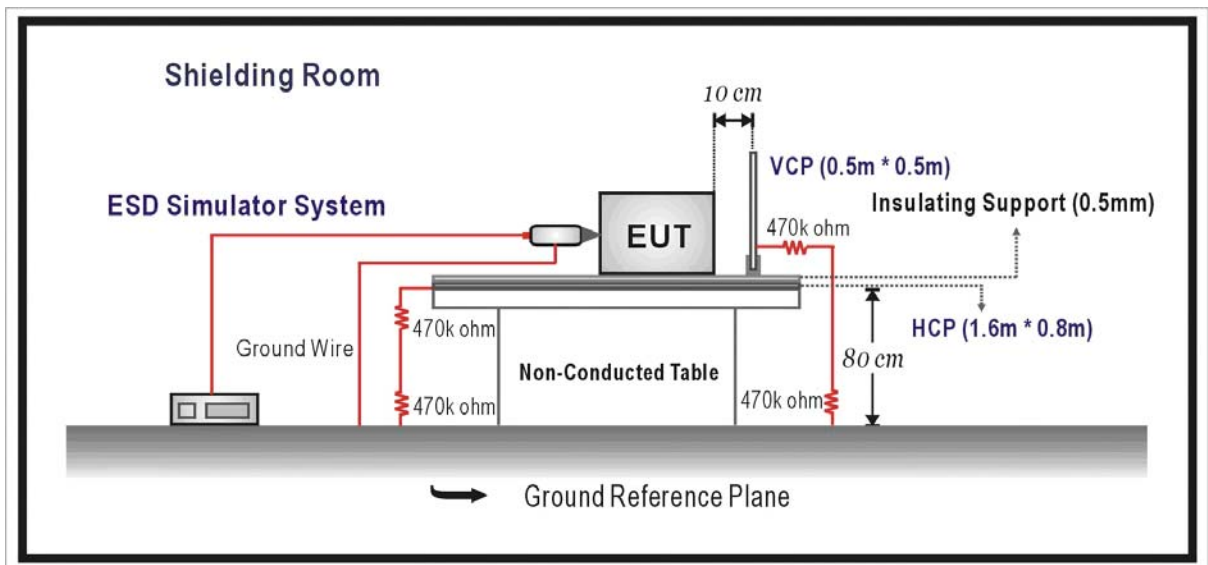

8.3. Limit

Item	Environmental Phenomena	Units	Test Specification	Performance Criteria
Enclosure Port				
	Electrostatic Discharge	kV(Charge Voltage)	±8 Air Discharge ±4 Contact Discharge	B

8.4. Test Procedure

Direct application of discharges to the EUT:

Contact discharge was applied only to conductive surfaces of the EUT.

Air discharges were applied only to non-conductive surfaces of the EUT.

During the test, it was performed with single discharges. For the single discharge time between successive single discharges will be keep longer 1 second. It was at least ten single discharges with positive and negative at the same selected point.

The selected point, which was performed with electrostatic discharge, was marked on the red label of the EUT.

Indirect application of discharges to the EUT:

Vertical Coupling Plane (VCP):

The coupling plane, of dimensions 0.5m x 0.5m, is placed parallel to, and positioned at a distance 0.1m from, the EUT, with the Discharge Electrode touching the coupling plane.

The four faces of the EUT will be performed with electrostatic discharge. It was at least ten single discharges with positive and negative at the same selected point.

Horizontal Coupling Plane (HCP):

The coupling plane is placed under to the EUT. The generator shall be positioned vertically at a distance of 0.1m from the EUT, with the Discharge Electrode touching the coupling plane.

The four faces of the EUT will be performed with electrostatic discharge. It was at least ten single discharges with positive and negative at the same selected point.

8.5. Deviation from Test Standard

No deviation.

8.6. Test Result

Product	Network Camera		
Test Item	Electrostatic Discharge		
Test Mode	Mode 1: Normal Operation, Adapter : 3A-183WP12		
Date of Test	2011/06/24	Test Site	No.6 Shielded Room

Item	Amount of Discharge	Voltage	Required Criteria	Complied To Criteria (A,B,C)	Results
Air Discharge	10	+8kV	B	A	Pass
	10	-8kV	B	A	Pass
Contact Discharge	25	+4kV	B	A	Pass
	25	-4kV	B	A	Pass
Indirect Discharge (HCP)	25	+4kV	B	A	Pass
	25	-4kV	B	A	Pass
Indirect Discharge (VCP Front)	25	+4kV	B	A	Pass
	25	-4kV	B	A	Pass
Indirect Discharge (VCP Left)	25	+4kV	B	A	Pass
	25	-4kV	B	A	Pass
Indirect Discharge (VCP Back)	25	+4kV	B	A	Pass
	25	-4kV	B	A	Pass
Indirect Discharge (VCP Right)	25	+4kV	B	A	Pass
	25	-4kV	B	A	Pass

Note:

The testing performed is from lowest level up to the highest level as required by standard, but only highest level is shown on the report.

NR: No Requirement

- Meet criteria A: Operate as intended during and after the test
- Meet criteria B: Operate as intended after the test
- Meet criteria C: Loss/Error of function
- Additional Information
 - EUT stopped operation and could / could not be reset by operator at ____ kV.
 - No false alarms or other malfunctions were observed during or after the test.

Remark:

The Contact discharges were applied at least total 200 discharges at a minimum of four test points.

Product	Network Camera		
Test Item	Electrostatic Discharge		
Test Mode	Mode 2: Normal Operation, Adapter : DE-60-24W		
Date of Test	2011/06/24	Test Site	No.6 Shielded Room

Item	Amount of Discharge	Voltage	Required Criteria	Complied To Criteria (A,B,C)	Results
Air Discharge	10	+8kV	B	A	Pass
	10	-8kV	B	A	Pass
Contact Discharge	25	+4kV	B	A	Pass
	25	-4kV	B	A	Pass
Indirect Discharge (HCP)	25	+4kV	B	A	Pass
	25	-4kV	B	A	Pass
Indirect Discharge (VCP Front)	25	+4kV	B	A	Pass
	25	-4kV	B	A	Pass
Indirect Discharge (VCP Left)	25	+4kV	B	A	Pass
	25	-4kV	B	A	Pass
Indirect Discharge (VCP Back)	25	+4kV	B	A	Pass
	25	-4kV	B	A	Pass
Indirect Discharge (VCP Right)	25	+4kV	B	A	Pass
	25	-4kV	B	A	Pass

Note:

The testing performed is from lowest level up to the highest level as required by standard, but only highest level is shown on the report.

NR: No Requirement

- Meet criteria A: Operate as intended during and after the test
- Meet criteria B: Operate as intended after the test
- Meet criteria C: Loss/Error of function
- Additional Information
 - EUT stopped operation and could / could not be reset by operator at ____ kV.
 - No false alarms or other malfunctions were observed during or after the test.

Remark:

The Contact discharges were applied at least total 200 discharges at a minimum of four test points.

Product	Network Camera		
Test Item	Electrostatic Discharge		
Test Mode	Mode 3: Normal Operation, PoE		
Date of Test	2011/06/24	Test Site	No.6 Shielded Room

Item	Amount of Discharge	Voltage	Required Criteria	Complied To Criteria (A,B,C)	Results
Air Discharge	10	+8kV	B	A	Pass
	10	-8kV	B	A	Pass
Contact Discharge	25	+4kV	B	A	Pass
	25	-4kV	B	A	Pass
Indirect Discharge (HCP)	25	+4kV	B	A	Pass
	25	-4kV	B	A	Pass
Indirect Discharge (VCP Front)	25	+4kV	B	A	Pass
	25	-4kV	B	A	Pass
Indirect Discharge (VCP Left)	25	+4kV	B	A	Pass
	25	-4kV	B	A	Pass
Indirect Discharge (VCP Back)	25	+4kV	B	A	Pass
	25	-4kV	B	A	Pass
Indirect Discharge (VCP Right)	25	+4kV	B	A	Pass
	25	-4kV	B	A	Pass

Note:

The testing performed is from lowest level up to the highest level as required by standard, but only highest level is shown on the report.

NR: No Requirement

- Meet criteria A: Operate as intended during and after the test
- Meet criteria B: Operate as intended after the test
- Meet criteria C: Loss/Error of function
- Additional Information
 - EUT stopped operation and could / could not be reset by operator at ____ kV.
 - No false alarms or other malfunctions were observed during or after the test.

Remark:

The Contact discharges were applied at least total 200 discharges at a minimum of four test points.

8.7. Test Photograph

Test Mode : Mode 1: Normal Operation, Adapter : 3A-183WP12

Description : ESD Test Setup



Test Mode : Mode 2: Normal Operation, Adapter : DE-60-24W

Description : ESD Test Setup



Test Mode : Mode 3: Normal Operation, PoE

Description : ESD Test Setup



9. Radiated Susceptibility

9.1. Test Specification

According to Standard : IEC 61000-4-3

9.2. Test Setup

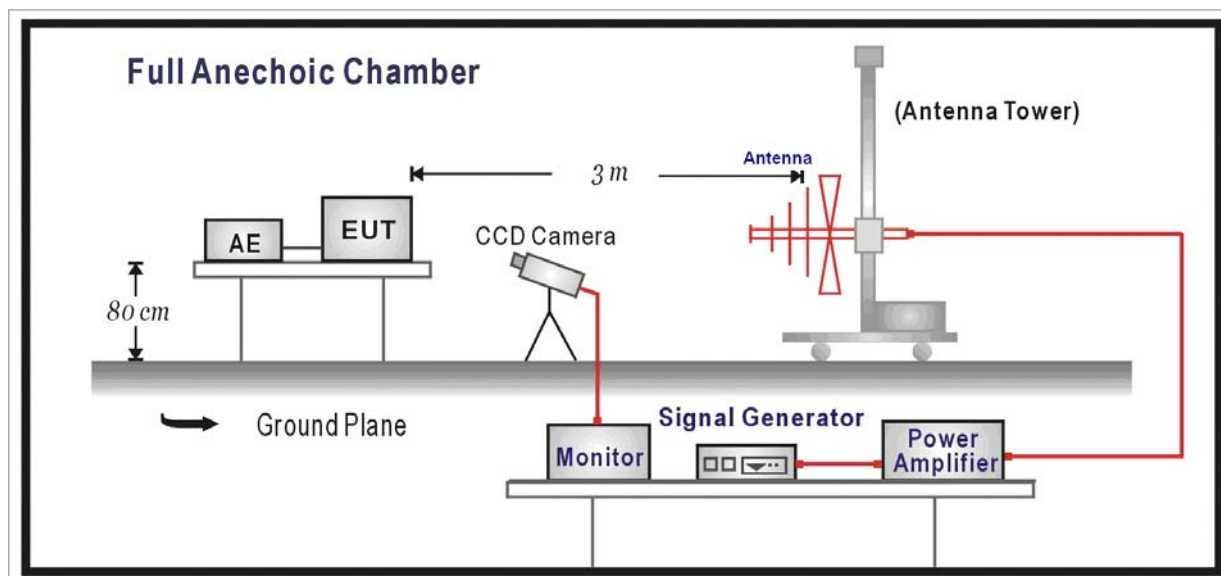

9.3. Limit

Item	Environmental Phenomena	Units	Test Specification	Performance Criteria
Enclosure Port				
	Radio-Frequency	MHz	80-1000	A
	Electromagnetic Field	V/m(Un-modulated, rms)	3	
	Amplitude Modulated	% AM (1kHz)	80	

9.4. Test Procedure

The EUT and load, which are placed on a table that is 0.8 meter above ground, are placed with one coincident with the calibration plane such that the distance from antenna to the EUT was 3 meters.

Both horizontal and vertical polarization of the antenna and four sides of the EUT are set on measurement.

In order to judge the EUT performance, a CCD camera is used to monitor EUT screen.

All the scanning conditions are as follows:

Condition of Test	Remarks
1. Field Strength	3 V/m Level 2
2. Radiated Signal	AM 80% Modulated with 1kHz
3. Scanning Frequency	80MHz - 1000MHz
4. Dwell Time	3 Seconds
5. Frequency step size Δf :	1%
6. The rate of Swept of Frequency	1.5×10^{-3} decades/s

9.5. Deviation from Test Standard

No deviation.

9.6. Test Result

Product	Network Camera		
Test Item	Radiated susceptibility		
Test Mode	Mode 1: Normal Operation, Adapter : 3A-183WP12		
Date of Test	2011/06/24	Test Site	Chamber5

Frequency (MHz)	Position (Angle)	Polarity (H or V)	Field Strength (V/m)	Required Criteria	Complied To Criteria (A,B,C)	Results
80-1000	FRONT	H	3	A	A	PASS
80-1000	FRONT	V	3	A	A	PASS
80-1000	BACK	H	3	A	A	PASS
80-1000	BACK	V	3	A	A	PASS
80-1000	RIGHT	H	3	A	A	PASS
80-1000	RIGHT	V	3	A	A	PASS
80-1000	LEFT	H	3	A	A	PASS
80-1000	LEFT	V	3	A	A	PASS
80-1000	UP	H	3	A	A	PASS
80-1000	UP	V	3	A	A	PASS
80-1000	DOWN	H	3	A	A	PASS
80-1000	DOWN	V	3	A	A	PASS

Note:

The testing performed is from lowest level up to the highest level as required by standard, but only highest level is shown on the report.

- Meet criteria A: Operate as intended during and after the test
- Meet criteria B: Operate as intended after the test
- Meet criteria C: Loss/Error of function
- Additional Information
 - There was no observable degradation in performance.
 - EUT stopped operation and could / could not be reset by operator at _____ V/m at frequency _____ MHz.
- No false alarms or other malfunctions were observed during or after the test.

Product	Network Camera		
Test Item	Radiated susceptibility		
Test Mode	Mode 2: Normal Operation, Adapter : DE-60-24W		
Date of Test	2011/06/24	Test Site	Chamber5

Frequency (MHz)	Position (Angle)	Polarity (H or V)	Field Strength (V/m)	Required Criteria	Complied To Criteria (A,B,C)	Results
80-1000	FRONT	H	3	A	A	PASS
80-1000	FRONT	V	3	A	A	PASS
80-1000	BACK	H	3	A	A	PASS
80-1000	BACK	V	3	A	A	PASS
80-1000	RIGHT	H	3	A	A	PASS
80-1000	RIGHT	V	3	A	A	PASS
80-1000	LEFT	H	3	A	A	PASS
80-1000	LEFT	V	3	A	A	PASS
80-1000	UP	H	3	A	A	PASS
80-1000	UP	V	3	A	A	PASS
80-1000	DOWN	H	3	A	A	PASS
80-1000	DOWN	V	3	A	A	PASS

Note:

The testing performed is from lowest level up to the highest level as required by standard, but only highest level is shown on the report.

- Meet criteria A: Operate as intended during and after the test
- Meet criteria B: Operate as intended after the test
- Meet criteria C: Loss/Error of function
- Additional Information
 - There was no observable degradation in performance.
 - EUT stopped operation and could / could not be reset by operator at _____ V/m at frequency _____MHz.
- No false alarms or other malfunctions were observed during or after the test.

Product	Network Camera		
Test Item	Radiated susceptibility		
Test Mode	Mode 3: Normal Operation, PoE		
Date of Test	2011/06/24	Test Site	Chamber5

Frequency (MHz)	Position (Angle)	Polarity (H or V)	Field Strength (V/m)	Required Criteria	Complied To Criteria (A,B,C)	Results
80-1000	FRONT	H	3	A	A	PASS
80-1000	FRONT	V	3	A	A	PASS
80-1000	BACK	H	3	A	A	PASS
80-1000	BACK	V	3	A	A	PASS
80-1000	RIGHT	H	3	A	A	PASS
80-1000	RIGHT	V	3	A	A	PASS
80-1000	LEFT	H	3	A	A	PASS
80-1000	LEFT	V	3	A	A	PASS
80-1000	UP	H	3	A	A	PASS
80-1000	UP	V	3	A	A	PASS
80-1000	DOWN	H	3	A	A	PASS
80-1000	DOWN	V	3	A	A	PASS

Note:

The testing performed is from lowest level up to the highest level as required by standard, but only highest level is shown on the report.

- Meet criteria A: Operate as intended during and after the test
- Meet criteria B: Operate as intended after the test
- Meet criteria C: Loss/Error of function
- Additional Information
 - There was no observable degradation in performance.
 - EUT stopped operation and could / could not be reset by operator at _____ V/m at frequency _____ MHz.
- No false alarms or other malfunctions were observed during or after the test.

9.7. Test Photograph

Test Mode : Mode 1: Normal Operation, Adapter : 3A-183WP12

Description : Radiated Susceptibility Test Setup

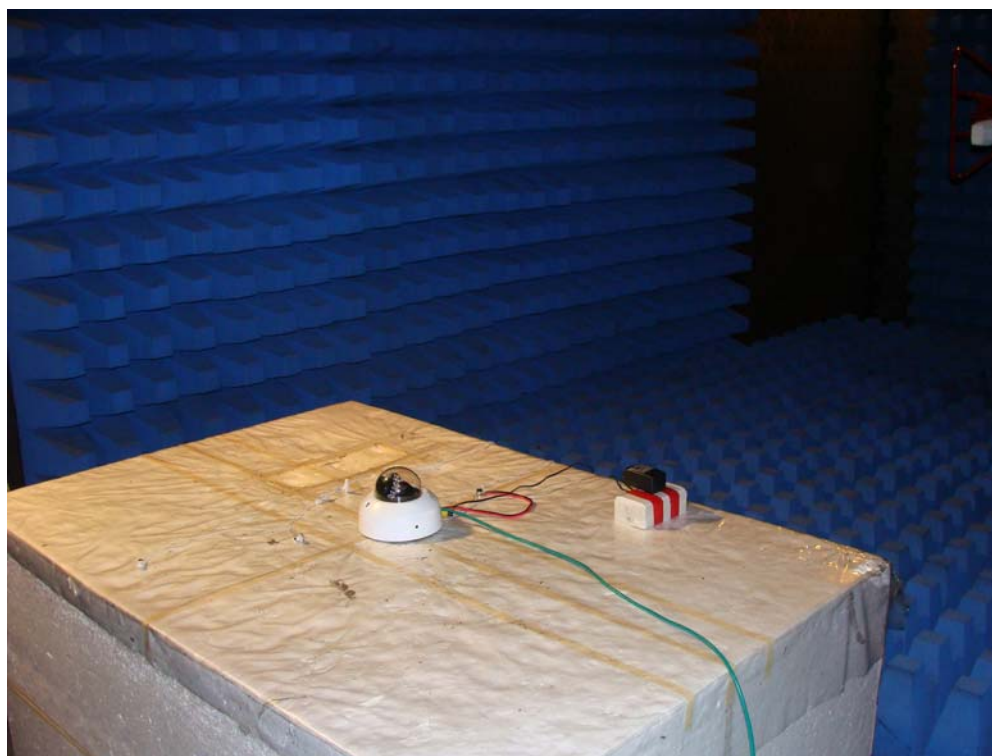

Test Mode : Mode 2: Normal Operation, Adapter : DE-60-24W

Description : Radiated Susceptibility Test Setup

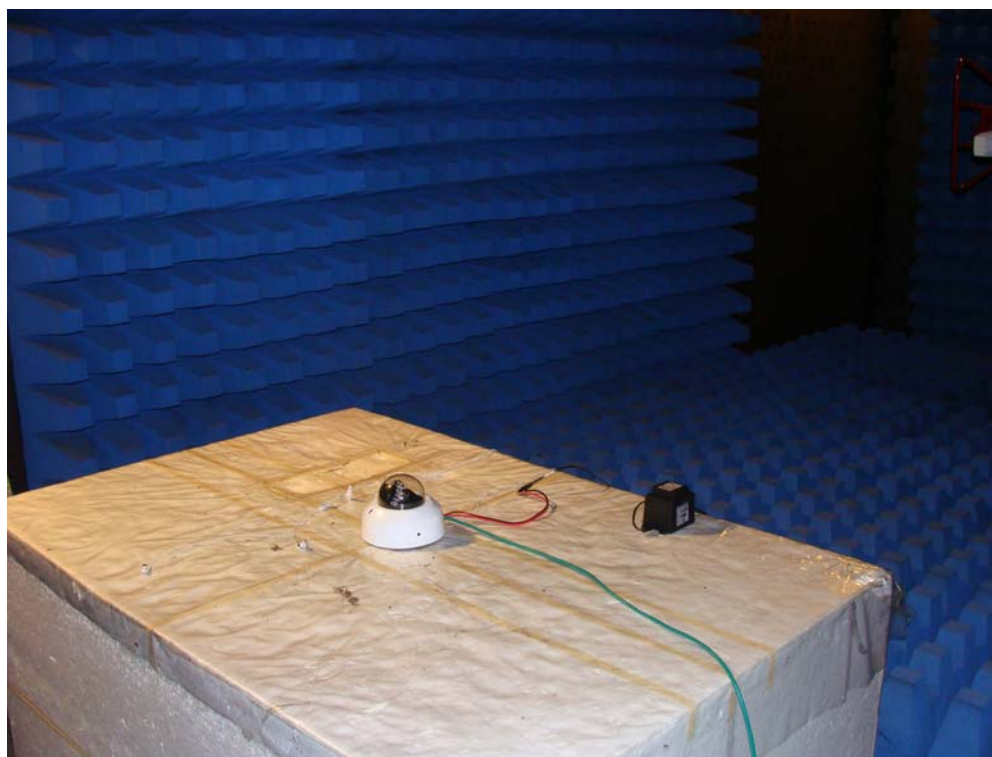

Test Mode : Mode 3: Normal Operation, PoE

Description : Radiated Susceptibility Test Setup

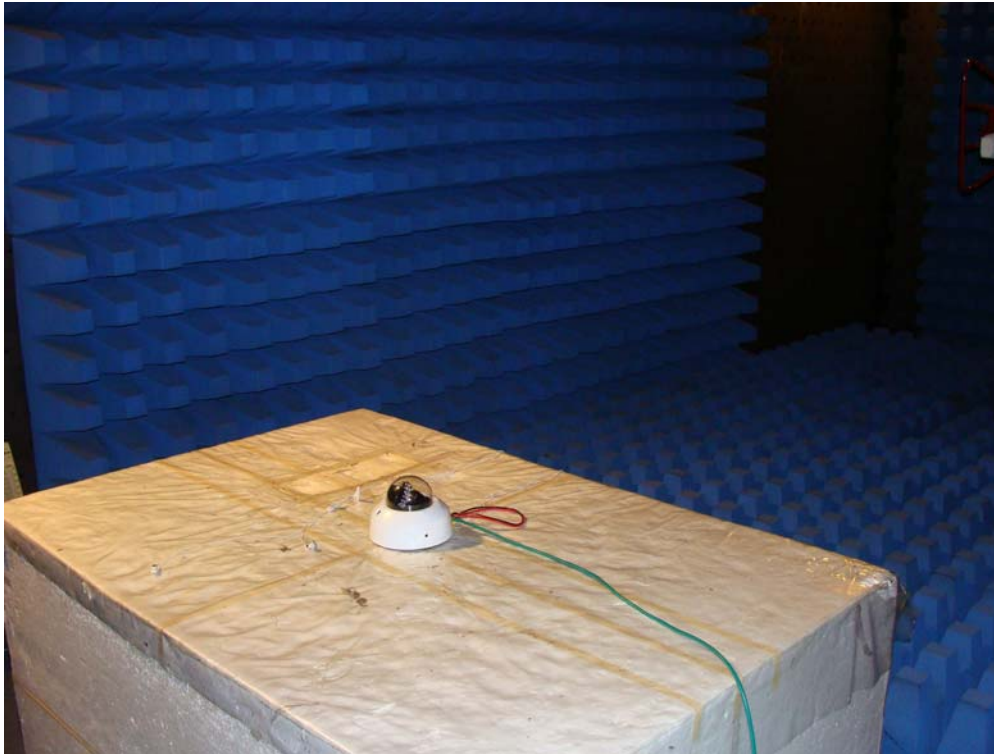

10. Electrical Fast Transient/Burst

10.1. Test Specification

According to Standard : IEC 61000-4-4

10.2. Test Setup

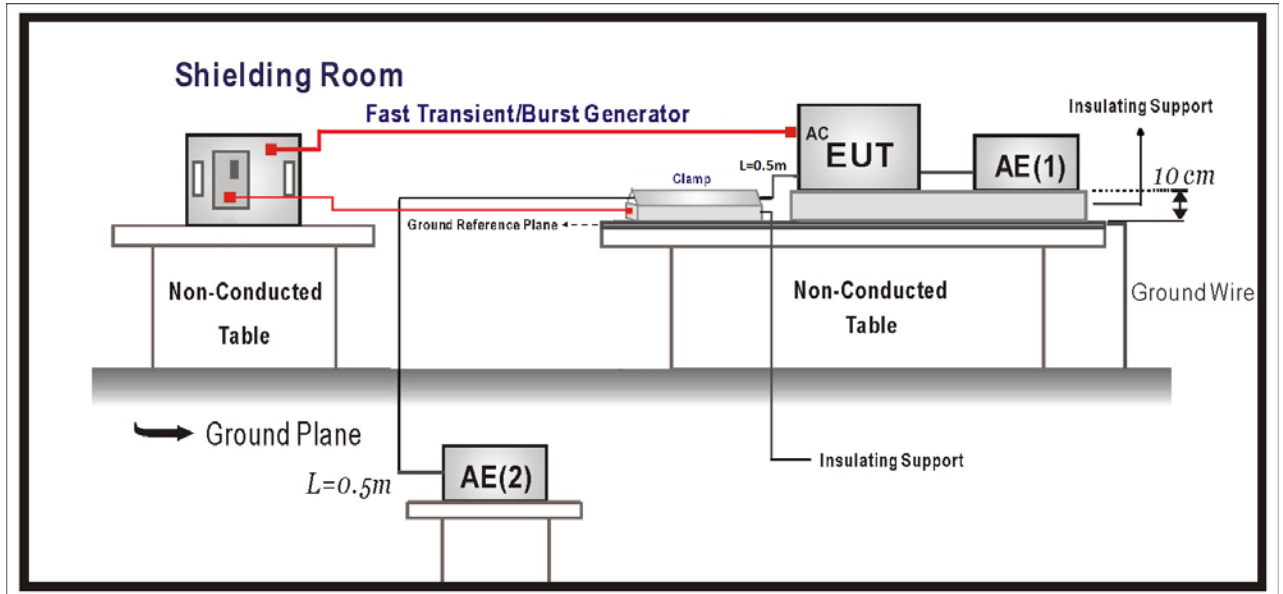

10.3. Limit

Item	Environmental Phenomena	Units	Test Specification	Performance Criteria
I/O and communication ports				
	Fast Transients Common Mode	kV (Peak) Tr/Th ns Rep. Frequency kHz	± 0.5 5/50 5	B
Input DC Power Ports				
	Fast Transients Common Mode	kV (Peak) Tr/Th ns Rep. Frequency kHz	± 0.5 5/50 5	B
Input AC Power Ports				
	Fast Transients Common Mode	kV (Peak) Tr/Th ns Rep. Frequency kHz	± 1 5/50 5	B

10.4. Test Procedure

The EUT is placed on a table that is 0.8 meter height. A ground reference plane is placed on the table, and uses a 0.1m insulation between the EUT and ground reference plane.

The minimum area of the ground reference plane is 1m*1m, and 0.65mm thick min, and projected beyond the EUT by at least 0.1m on all sides.

Test on I/O and communication ports:

The EFT interference signal is through a coupling clamp device couples to the signal and control lines of the EUT with burst noise for 1 minute.

Test on power supply ports:

The EUT is connected to the power mains through a coupling device that directly couples the EFT/B interference signal.

Each of the Line and Neutral conductors is impressed with burst noise for 1 minute.

The length of the signal and power lines between the coupling device and the EUT is 0.5m.

10.5. Deviation from Test Standard

No deviation.

10.6. Test Result

Product	Network Camera		
Test Item	Electrical fast transient/burst		
Test Mode	Mode 1: Normal Operation, Adapter : 3A-183WP12		
Date of Test	2011/06/24	Test Site	No.6 Shielded Room

Inject Line	Polarity	Voltage kV	Inject Time (Second)	Inject Method	Required Criteria	Complied to Criteria	Result
L-N	±	1kV	60	Direct	B	A	PASS
LAN	±	0.5 kV	60	Clamp	B	A	PASS

Note:

The testing performed is from lowest level up to the highest level as required by standard, but only highest level is shown on the report.

- Meet criteria A : Operate as intended during and after the test
- Meet criteria B : Operate as intended after the test
- Meet criteria C : Loss/Error of function
- Additional Information
 - EUT stopped operation and could / could not be reset by operator at _____ kV of Line _____.
- No false alarms or other malfunctions were observed during or after the test.

Product	Network Camera		
Test Item	Electrical fast transient/burst		
Test Mode	Mode 2: Normal Operation, Adapter : DE-60-24W		
Date of Test	2011/06/24	Test Site	No.6 Shielded Room

Inject Line	Polarity	Voltage kV	Inject Time (Second)	Inject Method	Required Criteria	Complied to Criteria	Result
L-N	±	1kV	60	Direct	B	A	PASS
LAN	±	0.5 kV	60	Clamp	B	A	PASS

Note:

The testing performed is from lowest level up to the highest level as required by standard, but only highest level is shown on the report.

- Meet criteria A : Operate as intended during and after the test
- Meet criteria B : Operate as intended after the test
- Meet criteria C : Loss/Error of function
- Additional Information
 - EUT stopped operation and could / could not be reset by operator at _____ kV of Line _____.
- No false alarms or other malfunctions were observed during or after the test.

Product	Network Camera		
Test Item	Electrical fast transient/burst		
Test Mode	Mode 3: Normal Operation, PoE		
Date of Test	2011/06/24	Test Site	No.6 Shielded Room

Inject Line	Polarity	Voltage kV	Inject Time (Second)	Inject Method	Required Criteria	Complied to Criteria	Result
LAN	±	0.5 kV	60	Clamp	B	A	PASS

Note:

The testing performed is from lowest level up to the highest level as required by standard, but only highest level is shown on the report.

- Meet criteria A : Operate as intended during and after the test
- Meet criteria B : Operate as intended after the test
- Meet criteria C : Loss/Error of function
- Additional Information
 - EUT stopped operation and could / could not be reset by operator at _____ kV of Line _____.
- No false alarms or other malfunctions were observed during or after the test.

10.7. Test Photograph

Test Mode : Mode 1: Normal Operation, Adapter : 3A-183WP12

Description : EFT/B Test Setup



Test Mode : Mode 1: Normal Operation, Adapter : 3A-183WP12

Description : EFT/B Test Setup - Clamp



Test Mode : Mode 2: Normal Operation, Adapter : DE-60-24W

Description : EFT/B Test Setup



Test Mode : Mode 2: Normal Operation, Adapter : DE-60-24W

Description : EFT/B Test Setup - Clamp



Test Mode : Mode 3: Normal Operation, PoE

Description : EFT/B Test Setup - Clamp



11. Surge

11.1. Test Specification

According to Standard : IEC 61000-4-5

11.2. Test Setup

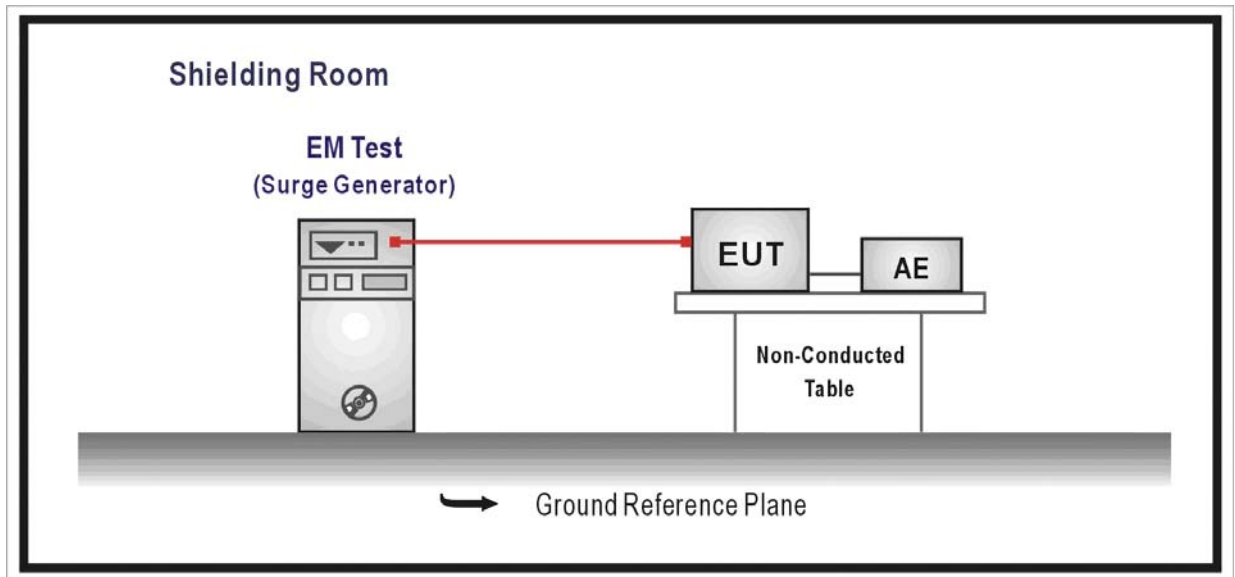

11.3. Limit

Item	Environmental Phenomena	Units	Test Specification	Performance Criteria
Signal Ports and Telecommunication Ports(See 1) and 2))				
	Surges Line to Ground	Tr/Th us kV	1.2/50 (8/20) ± 1	B
Input DC Power Ports				
	Surges Line to Ground	Tr/Th us kV	1.2/50 (8/20) ± 0.5	B
AC Input and AC Output Power Ports				
	Surges Line to Line Line to Ground	Tr/Th us kV kV	1.2/50 (8/20) ± 1 ± 2	B

Notes:

- 1) Applicable only to ports which according to the manufacturer’s may directly to outdoor cables.
- 2) Where normal functioning cannot be achieved because of the impact of the CDN on the EUT, no immunity test shall be required.

11.4. Test Procedure

The EUT and its load are placed on a table that is 0.8 meter above a metal ground plane measured 1m*1m min. and 0.65mm thick min. And projected beyond the EUT by at least 0.1m on all sides. The length of power cord between the coupling device and the EUT shall be 2m or less.

For Input and Output AC Power or DC Input and DC Output Power Ports:

The EUT is connected to the power mains through a coupling device that directly couples the Surge interference signal.

The surge noise shall be applied synchronized to the voltage phase at 0° , 90° , 180° , 270° and the peak value of the a.c. voltage wave. (Positive and negative)

Each of Line-Earth and Line-Line is impressed with a sequence of five surge voltages with interval of 1 min.

11.5. Deviation from Test Standard

No deviation.

11.6. Test Result

Product	Network Camera		
Test Item	Surge		
Test Mode	Mode 1: Normal Operation, Adapter : 3A-183WP12		
Date of Test	2011/06/24	Test Site	No.6 Shielded Room

Inject Line	Polarity	Angle	Voltage kV	Time Interval (Second)	Inject Method	Required Criteria	Complied to Criteria	Result
L-N	±	0	1kV	60	Direct	B	A	PASS
L-N	±	90	1kV	60	Direct	B	A	PASS
L-N	±	180	1kV	60	Direct	B	A	PASS
L-N	±	270	1kV	60	Direct	B	A	PASS

Note:

The testing performed is from lowest level up to the highest level as required by standard, but only highest level is shown on the report.

- Meet criteria A : Operate as intended during and after the test
- Meet criteria B : Operate as intended after the test
- Meet criteria C : Loss/Error of function
- Additional Information
 - EUT stopped operation and could / could not be reset by operator at _____ kV of Line _____.
- No false alarms or other malfunctions were observed during or after the test.

Product	Network Camera		
Test Item	Surge		
Test Mode	Mode 2: Normal Operation, Adapter : DE-60-24W		
Date of Test	2011/06/24	Test Site	No.6 Shielded Room

Inject Line	Polarity	Angle	Voltage kV	Time Interval (Second)	Inject Method	Required Criteria	Complied to Criteria	Result
L-N	±	0	1kV	60	Direct	B	A	PASS
L-N	±	90	1kV	60	Direct	B	A	PASS
L-N	±	180	1kV	60	Direct	B	A	PASS
L-N	±	270	1kV	60	Direct	B	A	PASS

Note:

The testing performed is from lowest level up to the highest level as required by standard, but only highest level is shown on the report.

- Meet criteria A : Operate as intended during and after the test
- Meet criteria B : Operate as intended after the test
- Meet criteria C : Loss/Error of function
- Additional Information
 - EUT stopped operation and could / could not be reset by operator at _____ kV of Line _____.
- No false alarms or other malfunctions were observed during or after the test.

11.7. Test Photograph

Test Mode : Mode 1: Normal Operation, Adapter : 3A-183WP12

Description : SURGE Test Setup



Test Mode : Mode 2: Normal Operation, Adapter : DE-60-24W

Description : SURGE Test Setup



12. Conducted Susceptibility

12.1. Test Specification

According to Standard : IEC 61000-4-6

12.2. Test Setup

CDN Test Mode

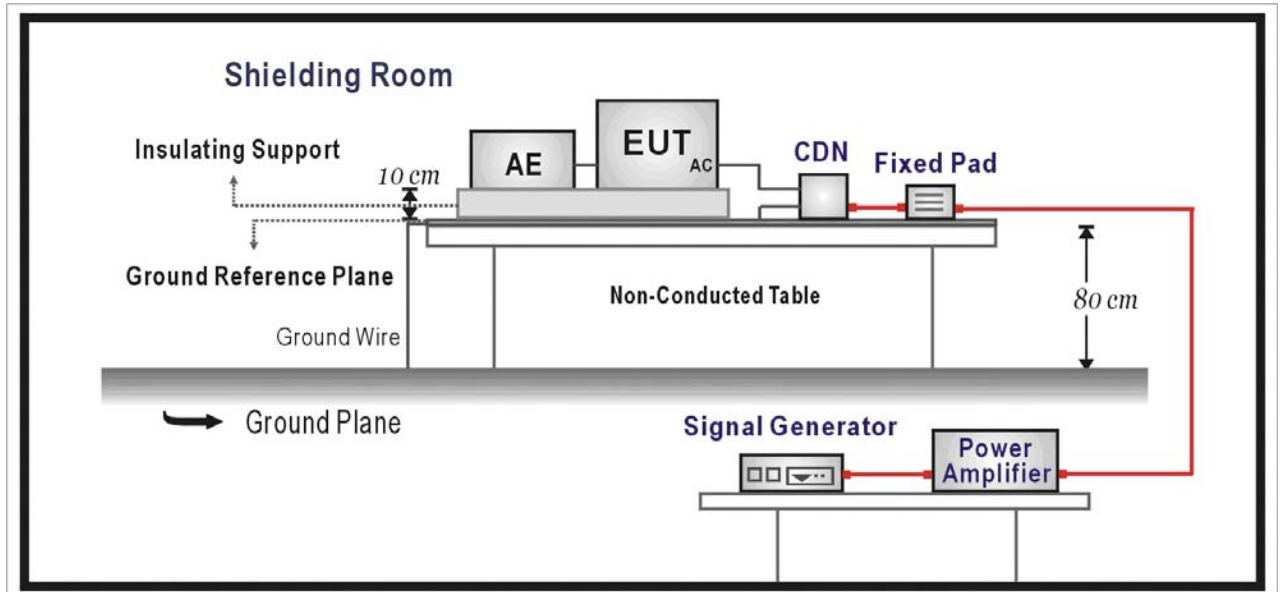

EM Clamp Test Mode

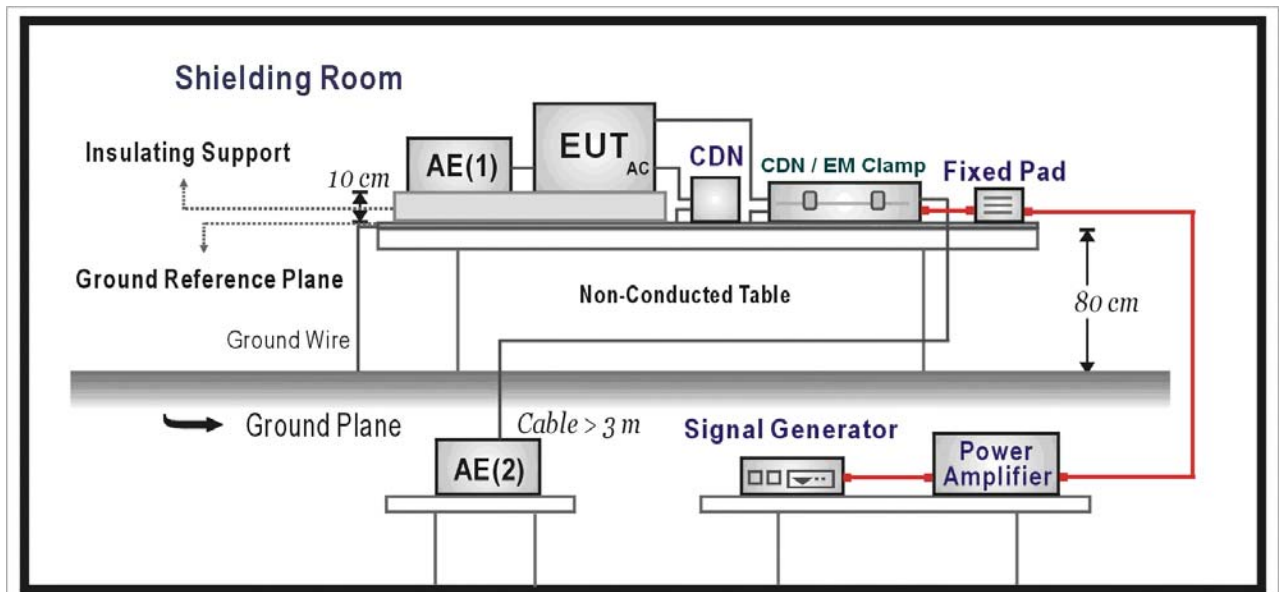

12.3. Limit

Item	Environmental Phenomena	Units	Test Specification	Performance Criteria
Signal Ports and Telecommunication Ports				
	Radio-Frequency Continuous Conducted	MHz V (rms, Un-modulated) % AM (1kHz)	0.15-80 3 80	A
Input DC Power Ports				
	Radio-Frequency Continuous Conducted	MHz V (rms, Un-modulated) % AM (1kHz)	0.15-80 3 80	A
Input AC Power Ports				
	Radio-Frequency Continuous Conducted	MHz V (rms, Un-modulated) % AM (1kHz)	0.15-80 3 80	A

12.4. Test Procedure

The EUT are placed on a table that is 0.8 meter height, and a Ground reference plane on the table, EUT are placed upon table and use a 10cm insulation between the EUT and Ground reference plane.

For Signal Ports and Telecommunication Ports

The disturbance signal is through a coupling and decoupling networks (CDN) or EM-clamp device couples to the signal and Telecommunication lines of the EUT.

For Input DC and AC Power Ports

The EUT is connected to the power mains through a coupling and decoupling networks for power supply lines. And directly couples the disturbances signal into EUT.

Used CDN-M2 for two wires or CDN-M3 for three wires.

All the scanning conditions are as follows:

Condition of Test	Remarks
1. Field Strength	130dBuV(3V) Level 2
2. Radiated Signal	AM 80% Modulated with 1kHz
3. Scanning Frequency	0.15MHz – 80MHz
4. Dwell Time	3 Seconds
5. Frequency step size Δf :	1%
6. The rate of Swept of Frequency	1.5×10^{-3} decades/s

12.5. Deviation from Test Standard

No deviation.

12.6. Test Result

Product	Network Camera		
Test Item	Conducted susceptibility		
Test Mode	Mode 1: Normal Operation, Adapter : 3A-183WP12		
Date of Test	2011/06/24	Test Site	No.6 Shielded Room

Frequency Range (MHz)	Voltage Applied dBuV(V)	Inject Method	Tested Port of EUT	Required Criteria	Performance Criteria Complied To	Result
0.15~80	130 (3V)	CDN	AC IN	A	A	PASS
0.15~80	130 (3V)	CDN	LAN	A	A	PASS

Note:

The testing performed is from lowest level up to the highest level as required by standard, but only highest level is shown on the report.

- Meet criteria A : Operate as intended during and after the test
- Meet criteria B : Operate as intended after the test
- Meet criteria C : Loss/Error of function
- Additional Information
 - EUT stopped operation and could / could not be reset by operator at _____ dBuV(V) at frequency _____MHz.
 - No false alarms or other malfunctions were observed during or after the test. The acceptance criteria were met, and the EUT passed the test.

Product	Network Camera		
Test Item	Conducted susceptibility		
Test Mode	Mode 2: Normal Operation, Adapter : DE-60-24W		
Date of Test	2011/06/24	Test Site	No.6 Shielded Room

Frequency Range (MHz)	Voltage Applied dBuV(V)	Inject Method	Tested Port of EUT	Required Criteria	Performance Criteria Complied To	Result
0.15~80	130 (3V)	CDN	AC IN	A	A	PASS
0.15~80	130 (3V)	CDN	LAN	A	A	PASS

Note:

The testing performed is from lowest level up to the highest level as required by standard, but only highest level is shown on the report.

- Meet criteria A : Operate as intended during and after the test
- Meet criteria B : Operate as intended after the test
- Meet criteria C : Loss/Error of function
- Additional Information
 - EUT stopped operation and could / could not be reset by operator at _____ dBuV(V) at frequency _____MHz.
 - No false alarms or other malfunctions were observed during or after the test. The acceptance criteria were met, and the EUT passed the test.

Product	Network Camera		
Test Item	Conducted susceptibility		
Test Mode	Mode 3: Normal Operation, PoE		
Date of Test	2011/06/24	Test Site	No.6 Shielded Room

Frequency Range (MHz)	Voltage Applied dBuV(V)	Inject Method	Tested Port of EUT	Required Criteria	Performance Criteria Complied To	Result
0.15~80	130 (3V)	Clamp	LAN	A	A	PASS

Note:

The testing performed is from lowest level up to the highest level as required by standard, but only highest level is shown on the report.

- Meet criteria A : Operate as intended during and after the test
- Meet criteria B : Operate as intended after the test
- Meet criteria C : Loss/Error of function
- Additional Information
 - EUT stopped operation and could / could not be reset by operator at _____ dBuV(V) at frequency _____MHz.
 - No false alarms or other malfunctions were observed during or after the test. The acceptance criteria were met, and the EUT passed the test.

12.7. Test Photograph

Test Mode : Mode 1: Normal Operation, Adapter : 3A-183WP12

Description : Conducted Susceptibility Test Setup



Test Mode : Mode 1: Normal Operation, Adapter : 3A-183WP12

Description : Conducted Susceptibility Test Setup - CDN



Test Mode : Mode 2: Normal Operation, Adapter : DE-60-24W

Description : Conducted Susceptibility Test Setup



Test Mode : Mode 2: Normal Operation, Adapter : DE-60-24W

Description : Conducted Susceptibility Test Setup - CDN



Test Mode : Mode 3: Normal Operation, PoE

Description : Conducted Susceptibility Test Setup - Clamp



13. Power Frequency Magnetic Field

13.1. Test Specification

According to Standard : IEC 61000-4-8

13.2. Test Setup

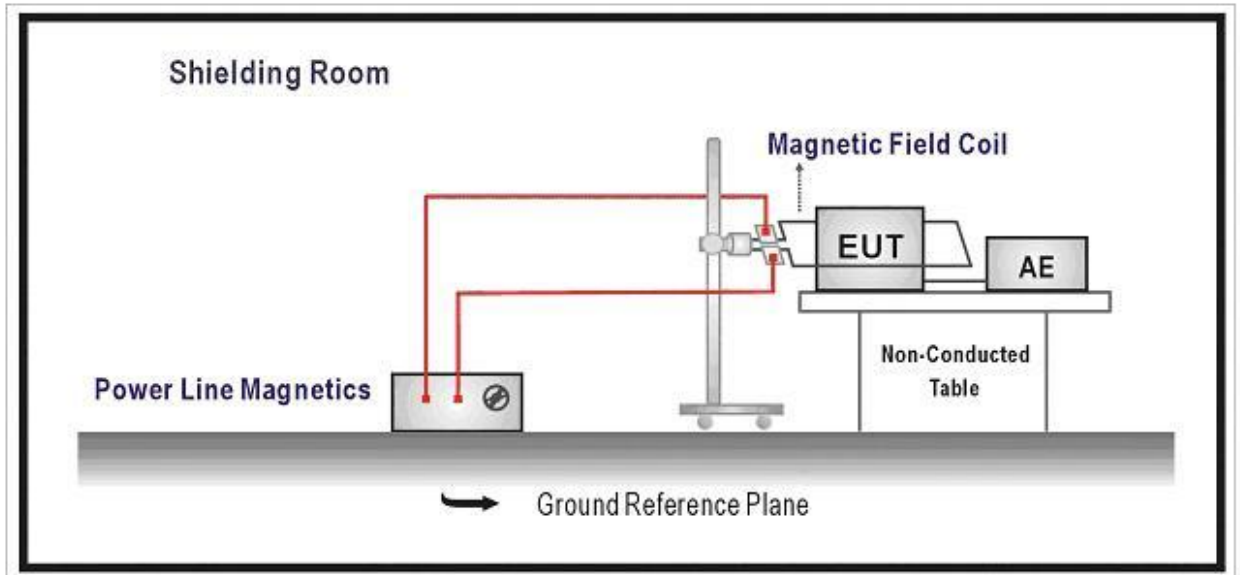

13.3. Limit

Item	Environmental Phenomena	Units	Test Specification	Performance Criteria
Enclosure Port				
	Power-Frequency Magnetic Field	Hz A/m (r.m.s.)	50 1	A

13.4. Test Procedure

The EUT and its load are placed on a table which is 0.8 meter above a metal ground plane measured at least 1m*1m min. The test magnetic field shall be placed at central of the induction coil.

The test magnetic Field shall be applied 10 minutes by the immersion method to the EUT. And the induction coil shall be rotated by 90° in order to expose the EUT to the test field with different orientation (X, Y, Z Orientations).

13.5. Deviation from Test Standard

No deviation.

13.6. Test Result

Product	Network Camera		
Test Item	Power frequency magnetic field		
Test Mode	Mode 1: Normal Operation, Adapter : 3A-183WP12		
Date of Test	2011/06/24	Test Site	No.3 Shielded Room

Polarization	Frequency (Hz)	Magnetic Strength (A/m)	Required Performance Criteria	Performance Criteria Complied To	Test Result
X Orientation	50	1	A	A	PASS
Y Orientation	50	1	A	A	PASS
Z Orientation	50	1	A	A	PASS

- Meet criteria A: Operate as intended during and after the test
- Meet criteria B: Operate as intended after the test
- Meet criteria C: Loss/Error of function
- Additional Information
 - EUT stopped operation and could / could not be reset by operator at _____ kV of Line _____.
- No false alarms or other malfunctions were observed during or after the test. The acceptance criteria were met, and the EUT passed the test.

Product	Network Camera		
Test Item	Power frequency magnetic field		
Test Mode	Mode 2: Normal Operation, Adapter : DE-60-24W		
Date of Test	2011/06/24	Test Site	No.3 Shielded Room

Polarization	Frequency (Hz)	Magnetic Strength (A/m)	Required Performance Criteria	Performance Criteria Complied To	Test Result
X Orientation	50	1	A	A	PASS
Y Orientation	50	1	A	A	PASS
Z Orientation	50	1	A	A	PASS

- Meet criteria A: Operate as intended during and after the test
- Meet criteria B: Operate as intended after the test
- Meet criteria C: Loss/Error of function
- Additional Information
 - EUT stopped operation and could / could not be reset by operator at _____ kV of Line _____.
- No false alarms or other malfunctions were observed during or after the test. The acceptance criteria were met, and the EUT passed the test.

Product	Network Camera		
Test Item	Power frequency magnetic field		
Test Mode	Mode 3: Normal Operation, PoE		
Date of Test	2011/06/24	Test Site	No.3 Shielded Room

Polarization	Frequency (Hz)	Magnetic Strength (A/m)	Required Performance Criteria	Performance Criteria Complied To	Test Result
X Orientation	50	1	A	A	PASS
Y Orientation	50	1	A	A	PASS
Z Orientation	50	1	A	A	PASS

- Meet criteria A: Operate as intended during and after the test
- Meet criteria B: Operate as intended after the test
- Meet criteria C: Loss/Error of function
- Additional Information
 - EUT stopped operation and could / could not be reset by operator at _____ kV of Line _____.
- No false alarms or other malfunctions were observed during or after the test. The acceptance criteria were met, and the EUT passed the test.

13.7. Test Photograph

Test Mode : Mode 1: Normal Operation, Adapter : 3A-183WP12

Description : Power Frequency Magnetic Field Test Setup



Test Mode : Mode 2: Normal Operation, Adapter : DE-60-24W

Description : Power Frequency Magnetic Field Test Setup



Test Mode : Mode 3: Normal Operation, PoE

Description : Power Frequency Magnetic Field Test Setup

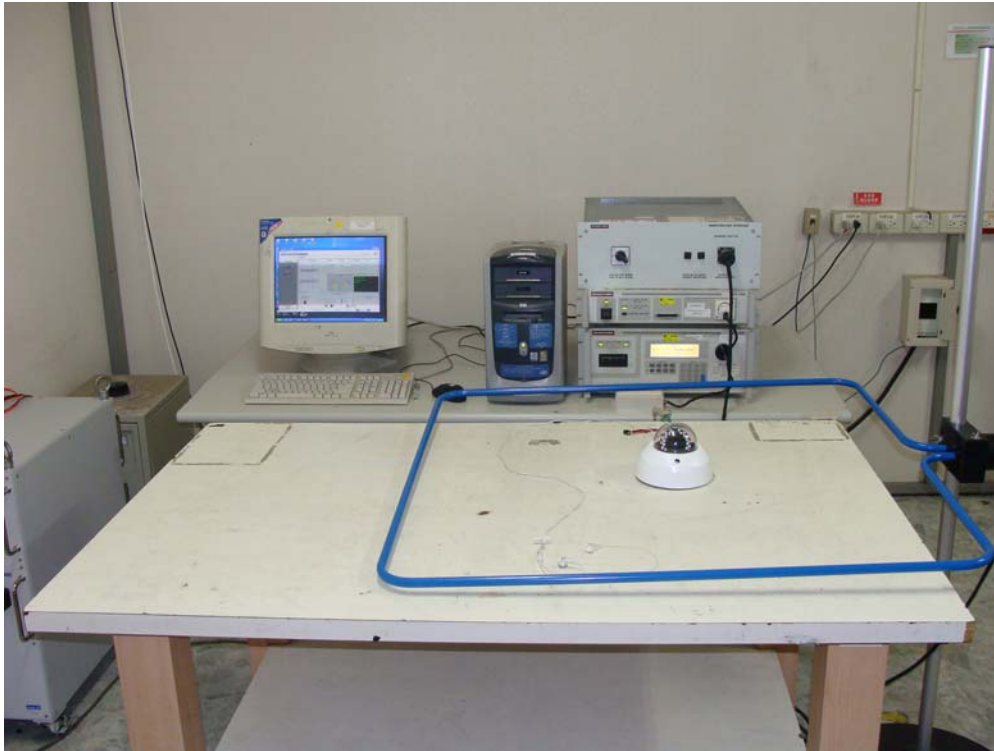

14. Voltage Dips and Interruption

14.1. Test Specification

According to Standard : IEC 61000-4-11

14.2. Test Setup

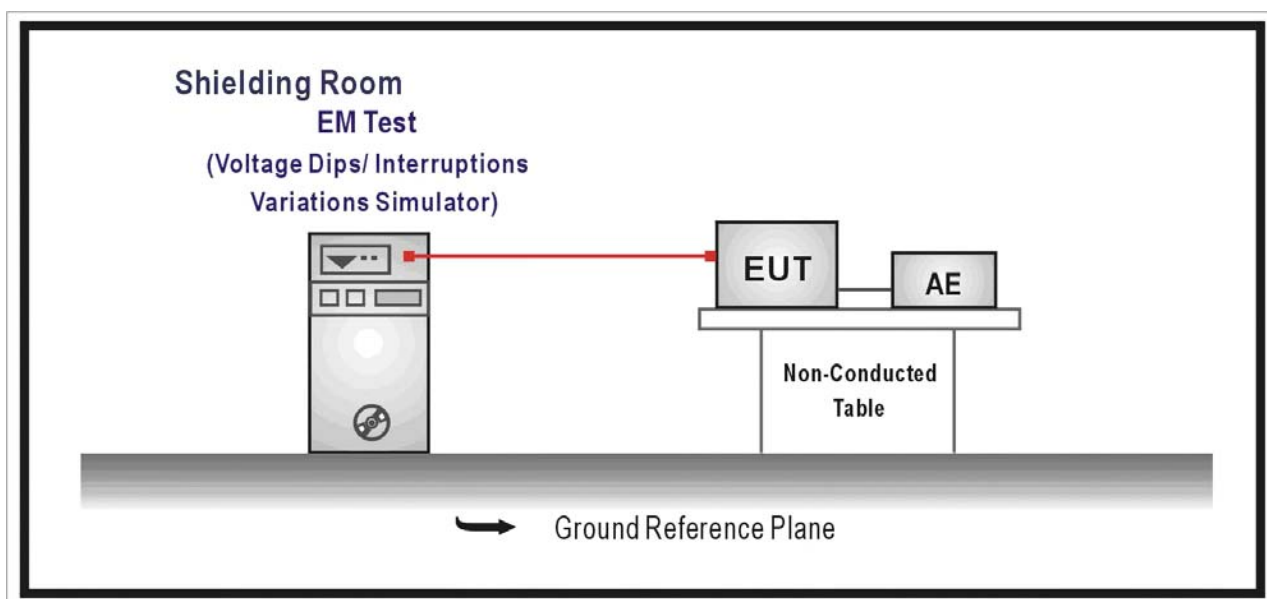

14.3. Limit

Item	Environmental Phenomena	Units	Test Specification	Performance Criteria
Input AC Power Ports				
Voltage Dips	% Reduction	30	C	
	Period	25		
Voltage Interruptions	% Reduction	>95	B	
	Period	0.5		
Voltage Interruptions	% Reduction	> 95	C	
	Period	250		

14.4. Test Procedure

The EUT and its load are placed on a table which is 0.8 meter above a metal ground plane measured 1m*1m min. And 0.65mm thick min. And projected beyond the EUT by at least 0.1m on all sides. The power cord shall be used the shortest power cord as specified by the manufacturer.

For Voltage Dips/ Interruptions test:

The selection of test voltage is based on the rated power range. If the operation range is large than 20% of lower power range, both end of specified voltage shall be tested.

Otherwise, the typical voltage specification is selected as test voltage.

The EUT is connected to the power mains through a coupling device that directly couples to the Voltage Dips and Interruption Generator.

The EUT shall be tested for 30% voltage dip of supplied voltage and duration 25 Periods, for 95% voltage dip of supplied voltage and duration 0.5 Periods with a sequence of three voltage dips with intervals of 10 seconds, and for 95% voltage interruption of supplied voltage and duration 250 Periods with a sequence of three voltage interruptions with intervals of 10 seconds.

Voltage phase shifting are shall occur at 0° , 45° , 90° , 135° , 180° , 225° , 270° , 315° of the voltage.

14.5. Deviation from Test Standard

No deviation.

14.6. Test Result

Product	Network Camera		
Test Item	Voltage dips and interruption		
Test Mode	Mode 1: Normal Operation, Adapter : 3A-183WP12		
Date of Test	2011/06/24	Test Site	No.6 Shielded Room

Voltage Dips and Interruption Reduction(%)	Angle	Test Duration (Periods)	Required Performance Criteria	Performance Criteria Complied To	Test Result
30	0	25	C	A	PASS
30	45	25	C	A	PASS
30	90	25	C	A	PASS
30	135	25	C	A	PASS
30	180	25	C	A	PASS
30	225	25	C	A	PASS
30	270	25	C	A	PASS
30	315	25	C	A	PASS
>95	0	0.5	B	A	PASS
>95	45	0.5	B	A	PASS
>95	90	0.5	B	A	PASS
>95	135	0.5	B	A	PASS
>95	180	0.5	B	A	PASS
>95	225	0.5	B	A	PASS
>95	270	0.5	B	A	PASS
>95	315	0.5	B	A	PASS
>95	0	250	C	B	PASS
>95	45	250	C	B	PASS
>95	90	250	C	B	PASS
>95	135	250	C	B	PASS
>95	180	250	C	B	PASS
>95	225	250	C	B	PASS
>95	270	250	C	B	PASS
>95	315	250	C	B	PASS

- Meet criteria A: Operate as intended during and after the test
- Meet criteria B: Operate as intended after the test
- Meet criteria C: Loss/Error of function
- Additional Information
 - The nominal voltage of EUT is 230V.
 - EUT stopped operation and could / could not be reset by operator at _____ kV of Line _____.

No false alarms or other malfunctions were observed during or after the test. The acceptance criteria were met, and the EUT passed the test.

Product	Network Camera		
Test Item	Voltage dips and interruption		
Test Mode	Mode 2: Normal Operation, Adapter : DE-60-24W		
Date of Test	2011/06/24	Test Site	No.6 Shielded Room

Voltage Dips and Interruption Reduction(%)	Angle	Test Duration (Periods)	Required Performance Criteria	Performance Criteria Complied To	Test Result
30	0	25	C	A	PASS
30	45	25	C	A	PASS
30	90	25	C	A	PASS
30	135	25	C	A	PASS
30	180	25	C	A	PASS
30	225	25	C	A	PASS
30	270	25	C	A	PASS
30	315	25	C	A	PASS
>95	0	0.5	B	A	PASS
>95	45	0.5	B	A	PASS
>95	90	0.5	B	A	PASS
>95	135	0.5	B	A	PASS
>95	180	0.5	B	A	PASS
>95	225	0.5	B	A	PASS
>95	270	0.5	B	A	PASS
>95	315	0.5	B	A	PASS
>95	0	250	C	B	PASS
>95	45	250	C	B	PASS
>95	90	250	C	B	PASS
>95	135	250	C	B	PASS
>95	180	250	C	B	PASS
>95	225	250	C	B	PASS
>95	270	250	C	B	PASS
>95	315	250	C	B	PASS

- Meet criteria A: Operate as intended during and after the test
- Meet criteria B: Operate as intended after the test
- Meet criteria C: Loss/Error of function
- Additional Information
 - The nominal voltage of EUT is 230V.
 - EUT stopped operation and could / could not be reset by operator at _____ kV of Line _____.
- No false alarms or other malfunctions were observed during or after the test. The acceptance criteria were met, and the EUT passed the test.

14.7. Test Photograph

Test Mode : Mode 1: Normal Operation, Adapter : 3A-183WP12

Description : Voltage Dips Test Setup



Test Mode : Mode 2: Normal Operation, Adapter : DE-60-24W

Description : Voltage Dips Test Setup



15. Attachment

➤ EUT Photograph

(1) EUT Photo



(2) EUT Photo



(3) EUT Photo



(4) EUT Photo



(5) EUT Photo



(6) EUT Photo



(7) EUT Photo



(8) EUT Photo



(9) EUT Photo



(10) EUT Photo

