



CERTIFICATE

Issued Date: Mar. 19, 2010
Report No.: 103180R-ITCEP11V03

This is to certify that the following designated product

Product : Outdoor Network Camera
Trade name : VIVOTEK
Model Number : IP8330, IP8332
Company Name : VIVOTEK INC.

This product, which has been issued the test report listed as above in Quietek Laboratory, is based on a single evaluation of one sample and confirmed to comply with the requirements of the following EMC standard.

EN 55022: 2006+A1: 2007

EN 61000-3-2:2006

EN 61000-3-3:1995+A1: 2001+A2: 2005

AS/NZS CISPR 22: 2006

EN 55024: 1998+A1: 2001+A2: 2003

IEC 61000-4-2 Edition 1.2: 2001-04

IEC 61000-4-3 Edition 3.0: 2006

IEC 61000-4-4: 2004

IEC 61000-4-5 Edition 2.0: 2005

IEC 61000-4-6 Edition 2.2: 2006

IEC 61000-4-8 Edition 1.1: 2001-03

IEC 61000-4-11 Second Edition: 2004-03

TEST LABORATORY

Vincent Lin / Manager



Test Report

Product Name : Outdoor Network Camera

Model No. : IP8330, IP8332

Applicant : VIVOTEK INC.

Address : 6F, No.192, Lien-Cheng Rd., Chung-Ho City, Taipei
County, Taiwan, R.O.C.

Date of Receipt : 2010/03/11

Issued Date : 2010/03/19

Report No. : 103180R-ITCEP11V03

Report Version : V1.0

The test results relate only to the samples tested.

The test results shown in the test report are traceable to the national/international standard through the calibration of the equipment and evaluated measurement uncertainty herein.

This report must not be used to claim product endorsement by TAF, NVLAP or any agency of the Government.

The test report shall not be reproduced except in full without the written approval of QuieTek Corporation.



Declaration of Conformity

We herewith confirm the following designated products to comply with the requirements set out in the Council Directive on the approximation of the laws of the Member States relating to Electromagnetic Compatibility Directive (2004/108/EC) with applicable standards listed below.

Product : Outdoor Network Camera
Trade name : VIVOTEK
Model Number : IP8330, IP8332
Applicable Harmonized : EN 55022:2006+A1: 2007, Class A
Standards under Directive EN 55024: 1998+A1: 2001+A2: 2003
2004/108/EC EN 61000-3-2:2006
EN 61000-3-3:1995+A1: 2001+A2: 2005

Company Name : _____
Company Address : _____
Telephone : _____ Facsimile : _____

Person in responsible for marking this declaration:

_____ Name (Full Name)	_____ Title/ Department
_____ Date	_____ Legal Signature



Statement of Conformity

This statement is to certify that the designated product below.

Product : Outdoor Network Camera
Trade name : VIVOTEK
Model Number : IP8330, IP8332
Company Name : VIVOTEK INC.
Applicable Standards : EN 55022:2006+A1: 2007, Class A
EN 55024: 1998+A1: 2001+A2: 2003
EN 61000-3-2:2006
EN 61000-3-3:1995+A1: 2001+A2: 2005

One sample of the designated product has been tested and evaluated in our laboratory to find in compliance with the applicable standards above. The issued test report(s) show(s) it in detail.

Report Number : 103180R-ITCEP11V03



NVLAP Lab Code: 200533-0



Testing Laboratory

0914

TEST LABORATORY

Vincent Lin / Manager

The verification is based on a single evaluation of one sample of above-mentioned products. It does not imply an assessment of the whole production and does not permit the use of the test lab. Logo.

Test Report Certification

Issued Date : 2010/03/19

Report No. : 103180R-ITCEP11V03

Quietek

Product Name : Outdoor Network Camera
Applicant : VIVOTEK INC.
Address : 6F, No.192, Lien-Cheng Rd., Chung-Ho City, Taipei County,
Taiwan, R.O.C.
Manufacturer : VIVOTEK INC.
Model No. : IP8330, IP8332
EUT Rated Voltage : AC 100-240V, 50-60Hz
EUT Test Voltage : 1. AC 100-240V/50-60Hz(Adapter)
2. By PoE
3. AC 24V
Trade Name : VIVOTEK
Applicable Standard : EN 55022: 2006+A1: 2007, Class A
EN 55024: 1998+A1: 2001+A2: 2003
EN 61000-3-2:2006
EN 61000-3-3:1995+A1: 2001+A2: 2005
AS/NZS CISPR 22: 2006
Test Result : Complied
Performed Location : Quietek Corporation (Linkou Laboratory)
No.5-22, Ruei-Shu Valley, Ruei-Ping Tsuen Lin Kuo Shiang,
Taipei, 244 Taiwan, R.O.C.
TEL:+866-2-8601-3788 / FAX:+886-2-8601-3789

Documented By :



(Adm. Specialist / Joanne Lin)

Reviewed By :



(Engineer / Elvis Su)

Approved By :



(Manager / Vincent Lin)

Laboratory Information

We , **Quietek Corporation**, are an independent EMC and safety consultancy that was established the whole facility in our laboratories. The test facility has been accredited/accepted (audited or listed) by the following related bodies in compliance with ISO 17025, EN 45001 and specified testing scopes:

Taiwan R.O.C.	:	BSMI, NCC, TAF
Germany	:	TUV Rheinland
Norway	:	Nemko, DNV
USA	:	FCC, NVLAP
Japan	:	VCCI

The related certificate for our laboratories about the test site and management system can be downloaded from Quietek Corporation's Web Site : <http://tw.quietek.com/tw/emc/accreditations/accreditations.htm>
The address and introduction of Quietek Corporation's laboratories can be founded in our Web site : <http://www.quietek.com/>

If you have any comments, Please don't hesitate to contact us. Our contact information is as below:

HsinChu Testing Laboratory :

No.75-2, 3rd Lin, Wangye Keng, Yonghxing Tsuen, Qionglin Shiang, Hsinchu County 307, Taiwan, R.O.C.

TEL:+886-3-592-8858 / FAX:+886-3-592-8859

E-Mail : service@quietek.com



LinKou Testing Laboratory :

No. 5-22, Ruei-Shu Valley, Ruei-Ping Tsuen, Lin-Kou Shiang, Taipei, Taiwan, R.O.C.

TEL : 886-2-8601-3788 / FAX : 886-2-8601-3789

E-Mail : service@quietek.com



Suzhou (China) Testing Laboratory :

No. 99 Hongye Rd., Suzhou Industrial Park Loufeng Hi-Tech Development Zone., Suzhou,China.

TEL : +86-512-6251-5088 / FAX : +86-512-6251-5098

E-Mail : service@quietek.com



TABLE OF CONTENTS

Description	Page
1. General Information	7
1.1. EUT Description.....	7
1.2. Mode of Operation	8
1.3. Tested System Details	9
1.4. Configuration of Tested System	10
1.5. EUT Exercise Software.....	12
2. Technical Test	13
2.1. Summary of Test Result.....	13
2.2. List of Test Equipment	14
2.3. Measurement Uncertainty.....	17
2.4. Test Environment.....	19
3. Conducted Emission (Main Terminals).....	20
3.1. Test Specification	20
3.2. Test Setup.....	20
3.3. Limit	20
3.4. Test Procedure	21
3.5. Deviation from Test Standard.....	21
3.6. Test Result	22
3.7. Test Photograph	28
4. Conducted Emissions (Telecommunication Ports).....	29
4.1. Test Specification	29
4.2. Test Setup.....	29
4.3. Limit	29
4.4. Test Procedure	30
4.5. Deviation from Test Standard.....	30
4.6. Test Result	31
4.7. Test Photograph	43
5. Radiated Emission	45
5.1. Test Specification	45
5.2. Test Setup.....	45
5.3. Limit	46
5.4. Test Procedure	47
5.5. Deviation from Test Standard.....	47
5.6. Test Result.....	48
5.7. Test Photograph	52
6. Harmonic Current Emission	54

6.1.	Test Specification	54
6.2.	Test Setup.....	54
6.3.	Limit.....	54
6.4.	Test Procedure	56
6.5.	Deviation from Test Standard.....	56
6.6.	Test Result.....	57
6.7.	Test Photograph	59
7.	Voltage Fluctuation and Flicker.....	60
7.1.	Test Specification.....	60
7.2.	Test Setup.....	60
7.3.	Limit.....	60
7.4.	Test Procedure	61
7.5.	Deviation from Test Standard.....	61
7.6.	Test Result.....	62
7.7.	Test Photograph	63
8.	Electrostatic Discharge	64
8.1.	Test Specification.....	64
8.2.	Test Setup.....	64
8.3.	Limit.....	64
8.4.	Test Procedure	65
8.5.	Deviation from Test Standard.....	65
8.6.	Test Result.....	66
8.7.	Test Photograph	67
9.	Radiated Susceptibility	68
9.1.	Test Specification.....	68
9.2.	Test Setup.....	68
9.3.	Limit.....	68
9.4.	Test Procedure	69
9.5.	Deviation from Test Standard.....	69
9.6.	Test Result.....	70
9.7.	Test Photograph	71
10.	Electrical Fast Transient/Burst	72
10.1.	Test Specification.....	72
10.2.	Test Setup.....	72
10.3.	Limit.....	72
10.4.	Test Procedure	73
10.5.	Deviation from Test Standard.....	73
10.6.	Test Result.....	74

10.7.	Test Photograph	76
11.	Surge	78
11.1.	Test Specification	78
11.2.	Test Setup.....	78
11.3.	Limit.....	78
11.4.	Test Procedure	79
11.5.	Deviation from Test Standard.....	79
11.6.	Test Result.....	80
11.7.	Test Photograph	81
12.	Conducted Susceptibility.....	82
12.1.	Test Specification	82
12.2.	Test Setup.....	82
12.3.	Limit.....	83
12.4.	Test Procedure	83
12.5.	Deviation from Test Standard.....	83
12.6.	Test Result.....	84
12.7.	Test Photograph	86
13.	Power Frequency Magnetic Field	88
13.1.	Test Specification	88
13.2.	Test Setup.....	88
13.3.	Limit.....	88
13.4.	Test Procedure	88
13.5.	Deviation from Test Standard.....	88
13.6.	Test Result.....	89
13.7.	Test Photograph	90
14.	Voltage Dips and Interruption.....	91
14.1.	Test Specification	91
14.2.	Test Setup.....	91
14.3.	Limit.....	91
14.4.	Test Procedure	92
14.5.	Deviation from Test Standard.....	92
14.6.	Test Result.....	93
14.7.	Test Photograph	94
15.	Attachment.....	95
	EUT Photograph.....	95

1. General Information

1.1. EUT Description

Product Name	Outdoor Network Camera
Trade Name	VIVOTEK
Model No.	IP8330, IP8332

Component	
Power Adapter	MFR: ENG, M/N: 3A-183WP12 Input: AC 100-240, 50-60Hz, 0.6A Output: DC 12V, 1.5A Cable Out: Non-shielded, 1.6m

Note: The different of each model is shown as below:

Model Number	Description
IP8330	VGA sensor
IP8332	1MP sensor

1.2. Mode of Operation

Quietek has verified the construction and function in typical operation. All the test modes were carried out with the EUT in normal operation, which was shown in this test report and defined as:

Pre-Test Mode	
Mode 1: Normal Operation (Adapter)	
Mode 2: Normal Operation (PoE)	
Mode 3: Normal Operation (AC 24V)	
Final Test Mode	
Conducted Emission	Mode 1: Normal Operation (Adapter)
Radiated Emission	Mode 1: Normal Operation (Adapter)
	Mode 2: Normal Operation (PoE)
Immunity	Mode 1: Normal Operation (Adapter)
	Mode 2: Normal Operation (PoE)

1.3. Tested System Details

The types for all equipments, plus descriptions of all cables used in the tested system (including inserted cards) are:

Test Mode		Mode 1			
Product		Manufacturer	Model No.	Serial No.	Power Cord
1	Notebook PC	DELL	PP04X	2D2ZM1S	Non-Shielded, 1.8m

Test Mode		Mode 2			
Product		Manufacturer	Model No.	Serial No.	Power Cord
1	Notebook PC	DELL	PP04X	2D2ZM1S	Non-Shielded, 0.8m
2	PoE	LINKSYS	WAPPDE12	N/A	Non-Shielded, 1.8m

1.4. Configuration of Tested System

Test Mode		Mode 1
Connection Diagram		
<pre> graph TD PC["Notebook PC (I)"] --- A --- EUT["EUT"] subgraph Box [] EUT end </pre>		
Signal Cable Type		Signal cable Description
A	LAN Cable	Non-Shielded, 3m

Test Mode		Mode 2	
Connection Diagram			
<pre> graph TD PoE["PoE (2)"] --- A --- NotebookPC["Notebook PC (1)"] PoE --- B --- EUT["EUT"] subgraph DashedBox [] B EUT end </pre>			
Signal Cable Type		Signal cable Description	
A	LAN Cable	Non-Shielded, 3m	
B	LAN Cable	Non-Shielded, 3m	

1.5. EUT Exercise Software

1	Setup the EUT and simulators as shown on 1.4.
2	Turn on the power of all equipment.
3	The EUT will start to operate and display the video figure from the signal source.
4	The EUT will display “video figure” on monitor.
5	Repeat the above procedure (3) to (4).

2. Technical Test

2.1. Summary of Test Result

- No deviations from the test standards
 Deviations from the test standards as below description:

Emission			
Performed Item	Normative References	Test Performed	Deviation
Conducted Emission	EN 55022: 2006+A1: 2007, Class A AS/NZS CISPR 22: 2006	Yes	No
Impedance Stabilization Network	EN 55022: 2006+A1: 2007, Class A AS/NZS CISPR 22: 2006	Yes	No
Radiated Emission	EN 55022: 2006+A1: 2007, Class A AS/NZS CISPR 22: 2006	Yes	No
Power Harmonics	EN 61000-3-2:2006	Yes	No
Voltage Fluctuation and Flicker	EN 61000-3-3:1995+A1: 2001+A2: 2005	Yes	No

Immunity			
Performed Item	Normative References	Test Performed	Deviation
Electrostatic Discharge	IEC 61000-4-2 Edition 1.2: 2001-04	Yes	No
Radiated susceptibility	IEC 61000-4-3 Edition 3.0: 2006	Yes	No
Electrical fast transient/burst	IEC 61000-4-4:2004	Yes	No
Surge	IEC 61000-4-5 Edition 2.0: 2005	Yes	No
Conducted susceptibility	IEC 61000-4-6 Edition 2.2: 2006	Yes	No
Power frequency magnetic field	IEC 61000-4-8 Edition 1.1: 2001-03	Yes	No
Voltage dips and interruption	IEC 61000-4-11 2nd Edition: 2004-03	Yes	No

2.2. List of Test Equipment

Conducted Emission / SR1

Instrument	Manufacturer	Type No.	Serial No	Cal. Date
EMI Test Receiver	R&S	ESCS 30	100366	2009/10/29
LISN	R&S	ENV4200	833209/007	2009/08/14
LISN	R&S	ENV216	100085	2010/02/17
Pulse Limiter	R&S	ESH3-Z2	357.88.10.52	2009/09/10

Impedance Stabilization Network / SR1

Instrument	Manufacturer	Type No.	Serial No	Cal. Date
Capacitive Voltage Probe	Schaffner	CVP2200A	18331	2009/11/16
EMI Test Receiver	R&S	ESCS 30	100366	2009/10/29
LISN	R&S	ENV216	100085	2010/02/17
LISN	R&S	ENV4200	833209/007	2009/08/14
Pulse Limiter	R&S	ESH3-Z2	357.88.10.52	2009/09/10
RF Current Probe	FCC	F-65 10KHz~1GHz	198	2009/11/13
BALANCED TELECOM ISN	FCC	FCC-TLISN-T2-02	20316	2009/11/22
BALANCED TELECOM ISN	FCC	FCC-TLISN-T4-02	20317	2009/11/22
BALANCED TELECOM ISN	FCC	FCC-TLISN-T8-02	20319	2009/11/22

Radiated Emission / Site6

Instrument	Manufacturer	Type No.	Serial No	Cal. Date
Bilog Antenna	Schaffner Chase	CBL6112B	2909	2009/08/01
Broadband Horn Antenna	Schwarzbeck	BBHA9170	209	2009/07/25
EMI Test Receiver	R&S	ESCS 30	100368	2009/08/22
Horn Antenna	Schwarzbeck	BBHA9120D	305	2009/08/26
Pre-Amplifier	QTK	AP-025C	0506002	2009/08/01
Spectrum Analyzer	Advantest	R3162	120300652	2009/06/25

Radiated Emission / 9x6x6 Chamber

Instrument	Manufacturer	Type No.	Serial No	Cal. Date
Spectrum Analyzer (9K-26.5GHz)	Agilent	E4408B	MY45102743	2009/08/12
Horn Antenna	Schwarzbeck	9120D	576	2009/10/21
Pre-Amplifier	Quietek	AP-180C	CHM/071920	2009/08/04

Power Harmonics / SR3

Instrument	Manufacturer	Type No.	Serial No	Cal. Date
AC Power Source(Harmonic)	Schaffner	NSG 1007	HK54148	2009/08/11
IEC1000-4-X Analyzer(Flicker)	Schaffner	CCN 1000-1	X7 1887	2009/08/11

Voltage Fluctuation and Flicker / SR3

Instrument	Manufacturer	Type No.	Serial No	Cal. Date
AC Power Source(Harmonic)	Schaffner	NSG 1007	HK54148	2009/08/11
IEC1000-4-X Analyzer(Flicker)	Schaffner	CCN 1000-1	X7 1887	2009/08/11

Electrostatic Discharge / SR3

Instrument	Manufacturer	Type No.	Serial No	Cal. Date
ESD simulator system	TESEQ	NSG 438	695	2009/05/12
Horizontal Coupling Plane(HCP)	Quietek	HCP AL50	N/A	N/A
Vertical Coupling Plane(VCP)	Quietek	VCP AL50	N/A	N/A

Radiated susceptibility / CB5

Instrument	Manufacturer	Type No.	Serial No	Cal. Date
AF-BOX	R&S	AF-BOX ACCUST	100007	N/A
Audio Analyzer	R&S	UPL 16	100137	2009/04/15
Biconilog Antenna	EMCO	3149	00071675	N/A
Directional Coupler	A&R	DC 6180	22735	N/A
Dual Microphone Supply	B&K	5935	2426784	2009/04/16
Mouth Simulator	B&K	4227	2439692	2009/04/16
Power Amplifier	A&R	30S1G3	309453	N/A
Power Amplifier	A&R	100W10000M7	A285000010	N/A
Power Amplifier	SCHAFFNER	CBA9413B	4020	N/A
Power Amplifier	AR	75A250A	0325371	N/A
Power Meter	R&S	NRVD(P.M)	100219	2009/04/16
Pre-Amplifier	A&R	150A220	23067	N/A
Probe Microphone	B&K	4182	2278070	2009/04/16
Signal Generator	R&S	SML03	103330	2009/09/08

Electrical fast transient/burst / SR6

Instrument	Manufacturer	Type No.	Serial No	Cal. Date
EMC immunity system	Thermo	EMCPRO PLUS	0411225	2010/03/10

Surge / SR6

Instrument	Manufacturer	Type No.	Serial No	Cal. Date
EMC immunity system	Thermo	EMCPRO PLUS	0411225	2010/03/10

Conducted susceptibility / SR6

Instrument	Manufacturer	Type No.	Serial No	Cal. Date
Schaffner NSG 2070 RF-Generator	Schaffner	N/A	N/A	2009/04/21

Power frequency magnetic field / SR3

Instrument	Manufacturer	Type No.	Serial No	Cal. Date
Induction Coil Interface	Schaffner	INA 2141	6002	N/A
Magnetic Loop Coil	Schaffner	INA 702	160	N/A
Triaxial ELF Magnetic Field Meter	F.B.BELL	4090	114135	2009/03/27

Voltage dips and interruption / SR6

Instrument	Manufacturer	Type No.	Serial No	Cal. Date
EMC immunity system	Thermo	EMCPRO PLUS	0411225	2010/03/10

Schaffner NSG 2070 RF-Generator				
Instrument	Manufacturer	Type No.	Serial No	Cal. Date
CDN	Schaffner	CAL U100A	20405	N/A
CDN	Schaffner	TRA U150	20454	N/A
CDN M016S	Schaffner	CAL U100A	20410	N/A
CDN M016S	Schaffner	TRA U150	21167	N/A
CDN T002	Schaffner	CAL U100	20491	N/A
CDN T002	Schaffner	TRA U150	21169	N/A
CDN T400	Schaffner	CAL U100	17735	N/A
CDN T400	Schaffner	TRA U150	21166	N/A
Coupling Decoupling Network	Schaffner	CDN M016S	20823	2009/04/02
Coupling Decoupling Network	Schaffner	CDN T002	19018	2009/04/02
Coupling Decoupling Network	Schaffner	CDN T400	21226	2009/04/02
EM-CLAMP	Schaffner	KEMZ 801	21024	2009/04/02

2.3. Measurement Uncertainty

Conducted Emission

The measurement uncertainty is evaluated as ± 2.26 dB.

Impedance Stabilization Network

The measurement uncertainty is evaluated as ± 2.26 dB.

Radiated Emission

The measurement uncertainty is evaluated as ± 3.19 dB.

Electrostatic Discharge

As what is concluded in the document from Note2 of clause 5.4.6.2 of ISO/IEC 17025: 1999[2], the requirements for measurement uncertainty in ESD testing are deemed to have been satisfied, and the testing is reported in accordance with the relevant ESD standards. The immunity test signal from the ESD system meet the required specifications in IEC 61000-4-2 through the calibration report with the calibrated uncertainty for the waveform of voltage and timing as being 1.63 % and 2.76%.

Radiated susceptibility

As what is concluded in the document from Note2 of clause 5.4.6.2 of ISO/IEC 17025: 1999[2], the requirements for measurement uncertainty in RS testing are deemed to have been satisfied, and the testing is reported in accordance with the relevant RS standards. The immunity test signal from the RS system meet the required specifications in IEC 61000-4-3 through the calibration for the uniform field strength and monitoring for the test level with the uncertainty evaluation report for the electrical field strength as being 2.72 dB.

Electrical fast transient/burst

As what is concluded in the document from Note2 of clause 5.4.6.2 of ISO/IEC 17025: 1999[2], the requirements for measurement uncertainty in EFT/Burst testing are deemed to have been satisfied, and the testing is reported in accordance with the relevant EFT/Burst standards. The immunity test signal from the EFT/Burst system meet the required specifications in IEC 61000-4-4 through the calibration report with the calibrated uncertainty for the waveform of voltage, frequency and timing as being 1.63 % and 2.76%.

Surge

As what is concluded in the document from Note2 of clause 5.4.6.2 of ISO/IEC 17025: 1999[2], the requirements for measurement uncertainty in Surge testing are deemed to have been satisfied, and the testing is reported in accordance with the relevant Surge standards. The immunity test signal from the Surge system meet the required specifications in IEC 61000-4-5 through the calibration report with the calibrated uncertainty for the waveform of voltage and timing as being 1.63 % and 2.76%.

Conducted susceptibility

As what is concluded in the document from Note2 of clause 5.4.6.2 of ISO/IEC 17025: 1999[2], the requirements for measurement uncertainty in CS testing are deemed to have been satisfied, and the testing is reported in accordance with the relevant CS standards. The immunity test signal from the CS system meet the required specifications in IEC 61000-4-6 through the calibration for unmodulated signal and monitoring for the test level with the uncertainty evaluation report for the injected modulated signal level through CDN and EM Clamp/Direct Injection as being 3.72 dB and 2.78 dB.

Power frequency magnetic field

As what is concluded in the document from Note2 of clause 5.4.6.2 of ISO/IEC 17025: 1999[2], the requirements for measurement uncertainty in PFM testing are deemed to have been satisfied, and the testing is reported in accordance with the relevant PFM standards. The immunity test signal from the PFM system meet the required specifications in IEC 61000-4-8 through the calibration report with the calibrated uncertainty for the Gauss Meter to verify the output level of magnetic field strength as being 2 %.

Voltage dips and interruption

As what is concluded in the document from Note2 of clause 5.4.6.2 of ISO/IEC 17025: 1999[2], the requirements for measurement uncertainty in DIP testing are deemed to have been satisfied, and the testing is reported in accordance with the relevant DIP standards. The immunity test signal from the DIP system meet the required specifications in IEC 61000-4-11 through the calibration report with the calibrated uncertainty for the waveform of voltage and timing as being 1.63 % and 2.76%.

2.4. Test Environment

Performed Item	Items	Required	Actual
Conducted Emission	Temperature (°C)	15-35	25
	Humidity (%RH)	25-75	50
	Barometric pressure (mbar)	860-1060	950-1000
Impedance Stabilization Network	Temperature (°C)	15-35	25
	Humidity (%RH)	25-75	50
	Barometric pressure (mbar)	860-1060	950-1000
Radiated Emission	Temperature (°C)	15-35	25
	Humidity (%RH)	25-75	50
	Barometric pressure (mbar)	860-1060	950-1000
Electrostatic Discharge	Temperature (°C)	15-35	21
	Humidity (%RH)	30-60	51
	Barometric pressure (mbar)	860-1060	950-1000
Radiated susceptibility	Temperature (°C)	15-35	21
	Humidity (%RH)	25-75	51
	Barometric pressure (mbar)	860-1060	950-1000
Electrical fast transient/burst	Temperature (°C)	15-35	21
	Humidity (%RH)	25-75	51
	Barometric pressure (mbar)	860-1060	950-1000
Surge	Temperature (°C)	15-35	21
	Humidity (%RH)	10-75	51
	Barometric pressure (mbar)	860-1060	950-1000
Conducted susceptibility	Temperature (°C)	15-35	21
	Humidity (%RH)	25-75	51
	Barometric pressure (mbar)	860-1060	950-1000
Power frequency magnetic field	Temperature (°C)	15-35	21
	Humidity (%RH)	25-75	51
	Barometric pressure (mbar)	860-1060	950-1000
Voltage dips and interruption	Temperature (°C)	15-35	21
	Humidity (%RH)	25-75	51
	Barometric pressure (mbar)	860-1060	950-1000

3. Conducted Emission (Main Terminals)

3.1. Test Specification

According to EMC Standard : EN 55022 and AS/NZS CISPR 22

3.2. Test Setup

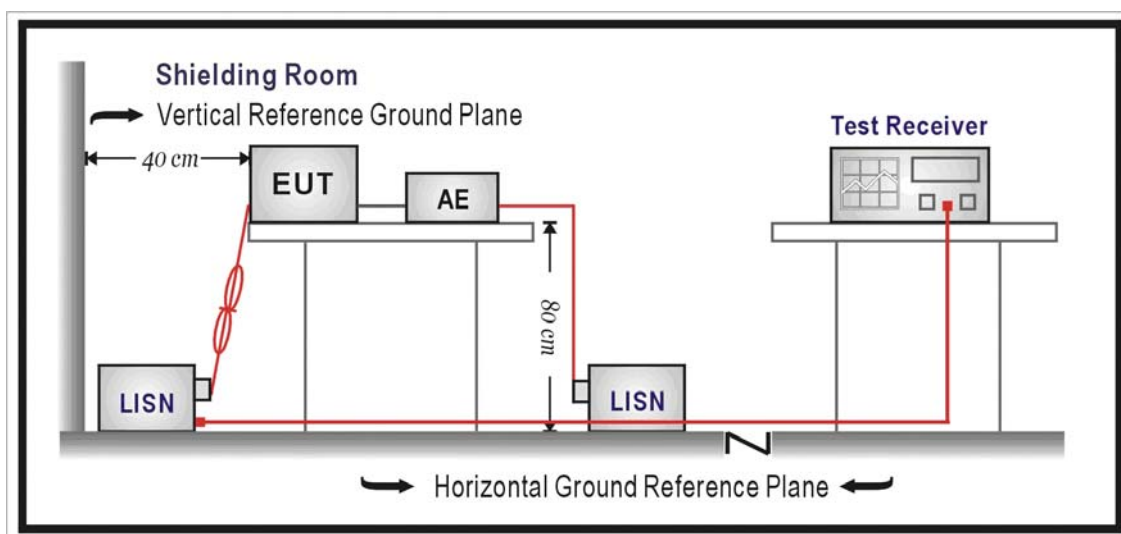

3.3. Limit

Limits		
Frequency (MHz)	QP (dBuV)	AV (dBuV)
0.15 - 0.50	79	66
0.50-5.0	73	60
5.0 - 30	73	60

Remarks: In the above table, the tighter limit applies at the band edges.

3.4. Test Procedure

The EUT and simulators are connected to the main power through a line impedance stabilization network (L.I.S.N.). This provides a 50 ohm /50uH coupling impedance for the measuring equipment. The peripheral devices are also connected to the main power through a LISN that provides a 50ohm/50uH coupling impedance with 50ohm termination.

(Please refers to the block diagram of the test setup and photographs.)

Both sides of A.C. line are checked for maximum conducted interference. In order to find the maximum emission, the relative positions of equipment and all of the interface cables must be changed on conducted measurement.

Conducted emissions were invested over the frequency range from 0.15MHz to 30MHz using a receiver bandwidth of 9kHz.

3.5. Deviation from Test Standard

No deviation.

3.6. Test Result

Site : SR1	Time : 2010/03/16 - 14:37
Limit : CISPR_A_00M_QP	Margin : 0
EUT : Outdoor Network Camera	Probe : ENV_216_L1 - Line1
Power : AC 230V/50Hz	Note : Mode 1



Site : SR1	Time : 2010/03/16 - 14:39
Limit : CISPR_A_00M_QP	Margin : 0
EUT : Outdoor Network Camera	Probe : ENV_216_L1 - Line1
Power : AC 230V/50Hz	Note : Mode 1

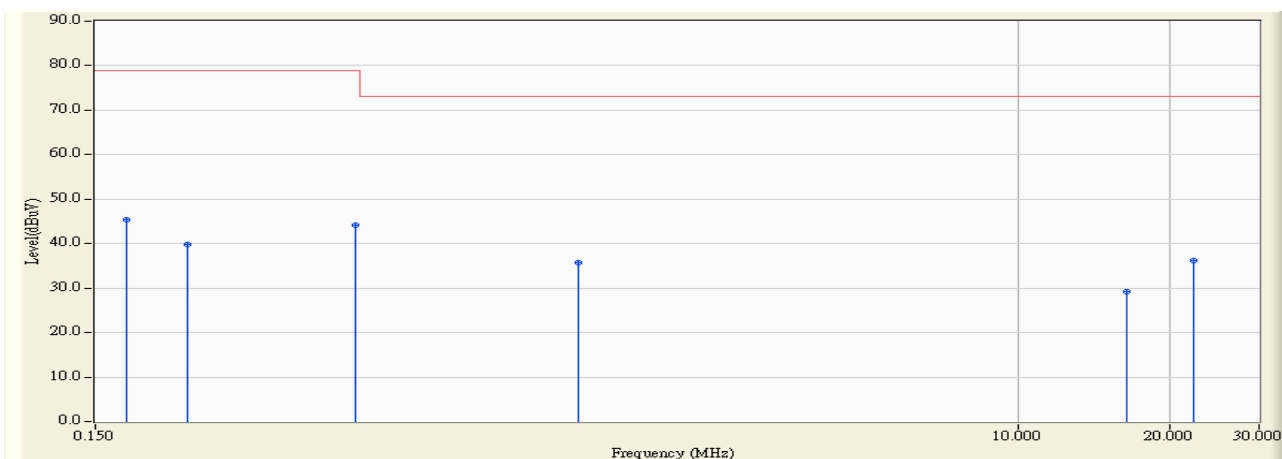

		Frequency (MHz)	Correct Factor (dB)	Reading Level (dBuV)	Measure Level (dBuV)	Margin (dB)	Limit (dBuV)	Detector Type
1	*	0.173	9.790	35.460	45.250	-33.750	79.000	QUASIPeAK
2		0.228	9.790	29.930	39.720	-39.280	79.000	QUASIPeAK
3		0.490	9.790	34.270	44.060	-34.940	79.000	QUASIPeAK
4		1.353	9.800	25.920	35.720	-37.280	73.000	QUASIPeAK
5		16.470	10.110	19.070	29.180	-43.820	73.000	QUASIPeAK
6		22.330	10.120	26.000	36.120	-36.880	73.000	QUASIPeAK

Note:

1. All Reading Levels are Quasi-Peak and average value.
2. " * ", means this data is the worst emission level.
3. Measurement Level = Reading Level + Correct Factor

Site : SR1	Time : 2010/03/16 - 14:39
Limit : CISPR_A_00M_AV	Margin : 0
EUT : Outdoor Network Camera	Probe : ENV_216_L1 - Line1
Power : AC 230V/50Hz	Note : Mode 1

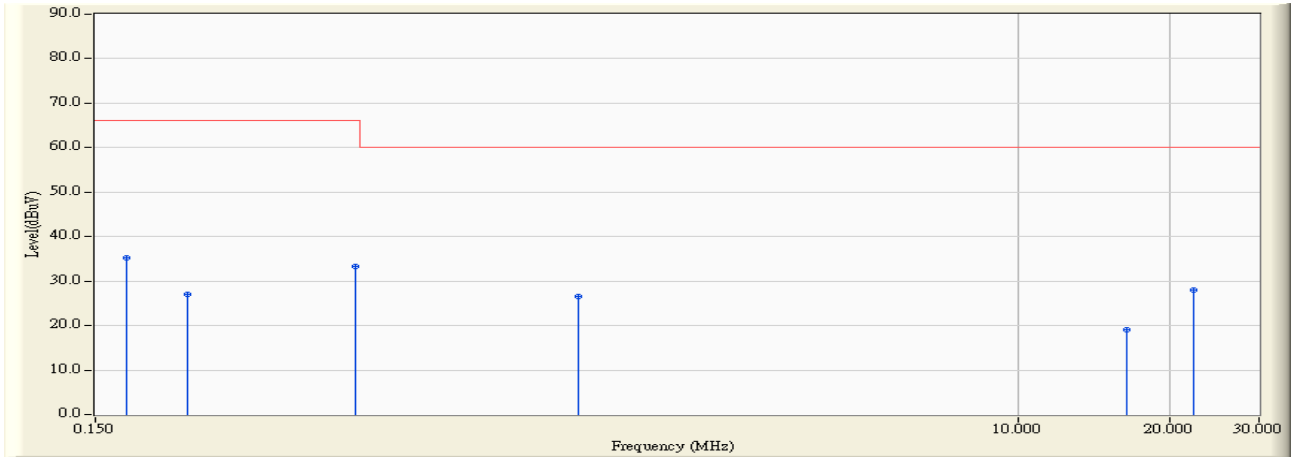

		Frequency (MHz)	Correct Factor (dB)	Reading Level (dBuV)	Measure Level (dBuV)	Margin (dB)	Limit (dBuV)	Detector Type
1	*	0.173	9.790	25.360	35.150	-30.850	66.000	AVERAGE
2		0.228	9.790	17.350	27.140	-38.860	66.000	AVERAGE
3		0.490	9.790	23.470	33.260	-32.740	66.000	AVERAGE
4		1.353	9.800	16.690	26.490	-33.510	60.000	AVERAGE
5		16.470	10.110	8.890	19.000	-41.000	60.000	AVERAGE
6		22.330	10.120	17.780	27.900	-32.100	60.000	AVERAGE

Note:

1. All Reading Levels are Quasi-Peak and average value.
2. " * ", means this data is the worst emission level.
3. Measurement Level = Reading Level + Correct Factor

Site : SR1	Time : 2010/03/16 - 14:40
Limit : CISPR_A_00M_QP	Margin : 10
EUT : Outdoor Network Camera	Probe : ENV_216_N - Line2
Power : AC 230V/50Hz	Note : Mode 1



Site : SR1	Time : 2010/03/16 - 14:41
Limit : CISPR_A_00M_QP	Margin : 0
EUT : Outdoor Network Camera	Probe : ENV_216_N - Line2
Power : AC 230V/50Hz	Note : Mode 1

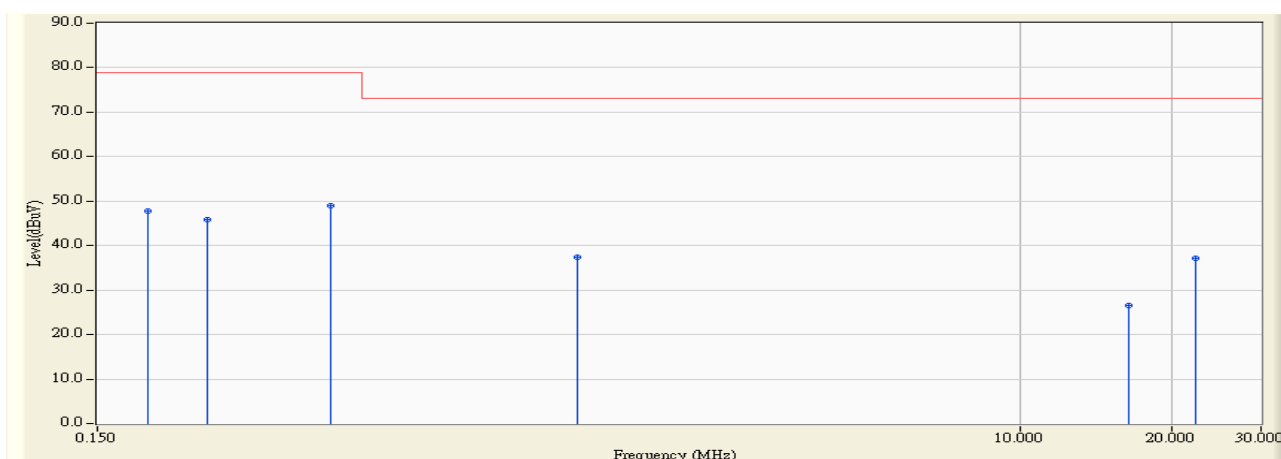

		Frequency (MHz)	Correct Factor (dB)	Reading Level (dBuV)	Measure Level (dBuV)	Margin (dB)	Limit (dBuV)	Detector Type
1		0.189	9.780	38.060	47.840	-31.160	79.000	QUASIPeAK
2		0.248	9.780	36.060	45.840	-33.160	79.000	QUASIPeAK
3	*	0.435	9.790	39.270	49.060	-29.940	79.000	QUASIPeAK
4		1.337	9.790	27.520	37.310	-35.690	73.000	QUASIPeAK
5		16.470	10.190	16.320	26.510	-46.490	73.000	QUASIPeAK
6		22.334	10.260	26.920	37.180	-35.820	73.000	QUASIPeAK

Note:

1. All Reading Levels are Quasi-Peak and average value.
2. " * ", means this data is the worst emission level.
3. Measurement Level = Reading Level + Correct Factor

Site : SR1	Time : 2010/03/16 - 14:41
Limit : CISPR_A_00M_AV	Margin : 0
EUT : Outdoor Network Camera	Probe : ENV_216_N - Line2
Power : AC 230V/50Hz	Note : Mode 1

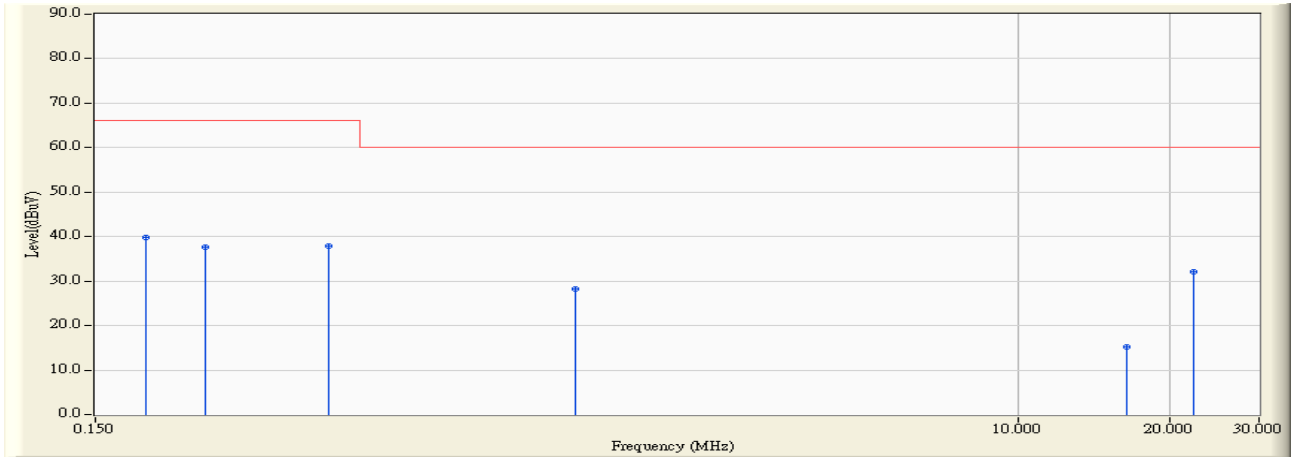

		Frequency (MHz)	Correct Factor (dB)	Reading Level (dBuV)	Measure Level (dBuV)	Margin (dB)	Limit (dBuV)	Detector Type
1	*	0.189	9.780	29.920	39.700	-26.300	66.000	AVERAGE
2		0.248	9.780	27.750	37.530	-28.470	66.000	AVERAGE
3		0.435	9.790	28.000	37.790	-28.210	66.000	AVERAGE
4		1.337	9.790	18.360	28.150	-31.850	60.000	AVERAGE
5		16.470	10.190	5.000	15.190	-44.810	60.000	AVERAGE
6		22.334	10.260	21.730	31.990	-28.010	60.000	AVERAGE

Note:

1. All Reading Levels are Quasi-Peak and average value.
2. " * ", means this data is the worst emission level.
3. Measurement Level = Reading Level + Correct Factor

3.7. Test Photograph

Test Mode : Mode 1: Normal Operation (Adapter)

Description : Front View of Conducted Test



Test Mode : Mode 1: Normal Operation (Adapter)

Description : Back View of Conducted Test



4. Conducted Emissions (Telecommunication Ports)

4.1. Test Specification

According to EMC Standard : EN 55022 and AS/NZS CISPR 22

4.2. Test Setup

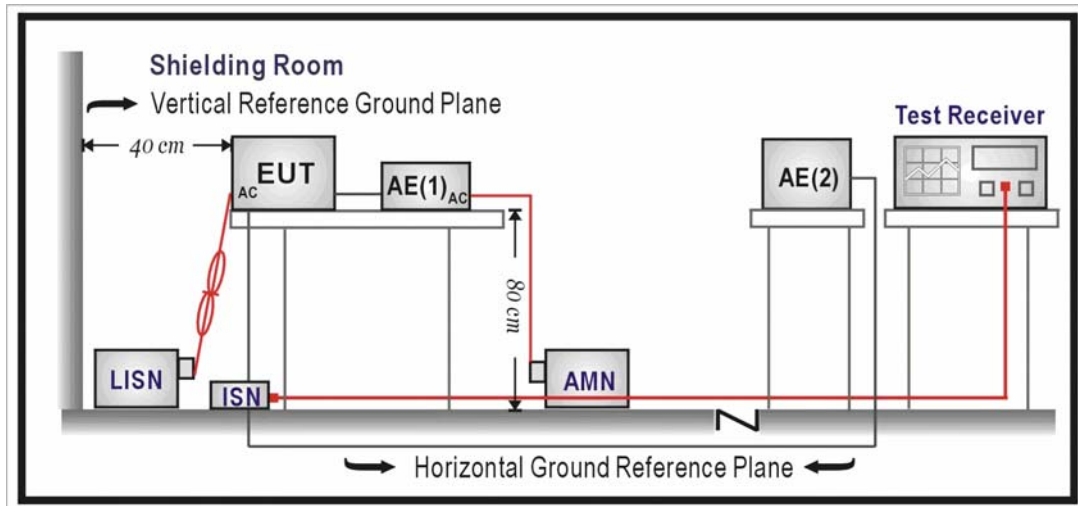

4.3. Limit

Limits		
Frequency (MHz)	QP (dBuV)	AV (dBuV)
0.15 - 0.50	97 – 87	84 – 74
0.50 - 30	87	74

Remarks:

The limit decreases linearly with the logarithm of the frequency in the range 0.15 MHz~0.50 MHz.

4.4. Test Procedure

Telecommunication Port:

The mains voltage shall be supplied to the EUT via the LISN when the measurement of telecommunication port is performed. The common mode disturbances at the telecommunication port shall be connected to the ISN, which is 150 ohm impedance.

Both alternative cables are tested related to the LCL requested. The measurement range is from 150kHz to 30MHz. The bandwidth of measurement is set to 9kHz.

The 75dB LCL ISN is used for cat. 6 cable, the 65dB LCL ISN is used for cat. 5 cable, 55dB LCL ISN is used for cat. 3.

4.5. Deviation from Test Standard

No deviation.

4.6. Test Result

Site : SR1	Time : 2010/03/16 - 14:56
Limit : ISN_Voltage_A_00M_QP	Margin : 10
EUT : Outdoor Network Camera	Probe : ISN_T4 - Line1
Power : AC 230V/50Hz	Note : Mode 1, ISN 10Mbps

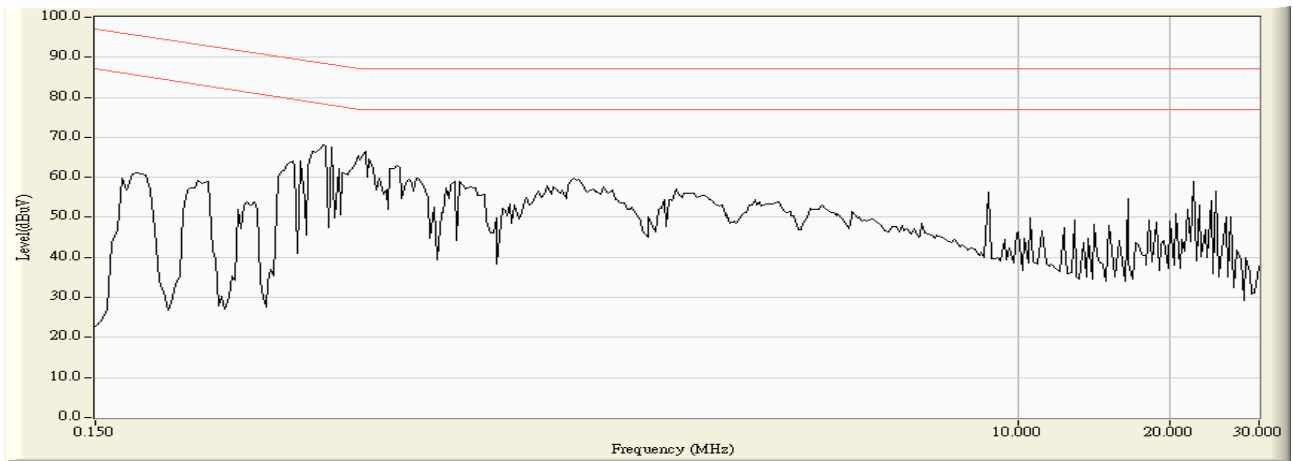

Site : SR1	Time : 2010/03/16 - 14:57
Limit : ISN_Voltage_A_00M_QP	Margin : 0
EUT : Outdoor Network Camera	Probe : ISN_T4 - Line1
Power : AC 230V/50Hz	Note : Mode 1, ISN 10Mbps

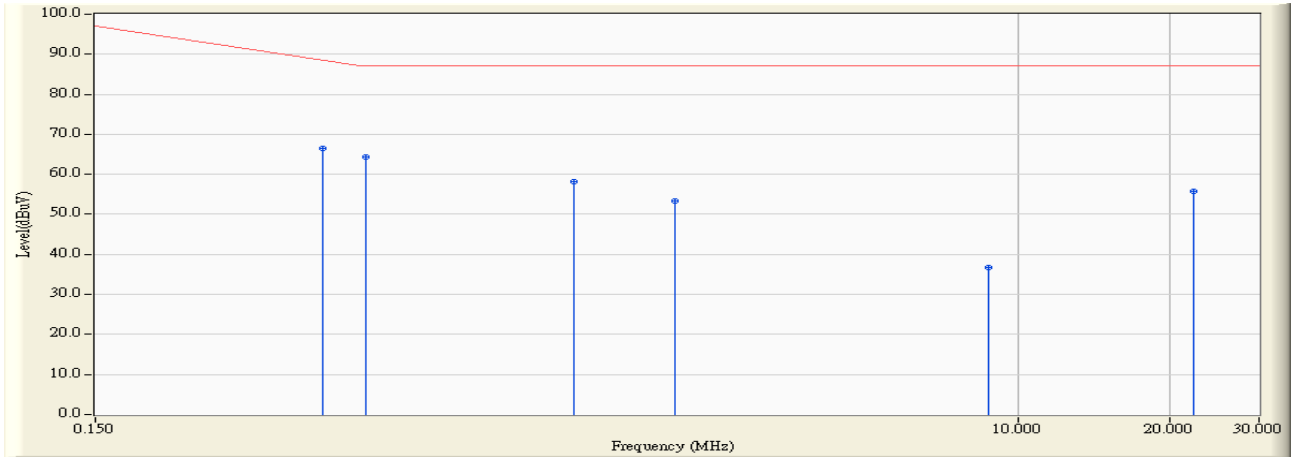

		Frequency (MHz)	Correct Factor (dB)	Reading Level (dBuV)	Measure Level (dBuV)	Margin (dB)	Limit (dBuV)	Detector Type
1		0.423	10.000	56.370	66.370	-22.830	89.200	QUASIPeAK
2	*	0.513	9.990	54.340	64.330	-22.670	87.000	QUASIPeAK
3		1.322	9.990	48.150	58.140	-28.860	87.000	QUASIPeAK
4		2.107	10.000	43.430	53.430	-33.570	87.000	QUASIPeAK
5		8.740	9.970	26.680	36.650	-50.350	87.000	QUASIPeAK
6		22.341	10.110	45.560	55.670	-31.330	87.000	QUASIPeAK

Note:

1. All Reading Levels are Quasi-Peak and average value.
2. " * ", means this data is the worst emission level.
3. Measurement Level = Reading Level + Correct Factor

Site : SR1	Time : 2010/03/16 - 14:57
Limit : ISN_Voltage_A_00M_AV	Margin : 0
EUT : Outdoor Network Camera	Probe : ISN_T4 - Line1
Power : AC 230V/50Hz	Note : Mode 1, ISN 10Mbps

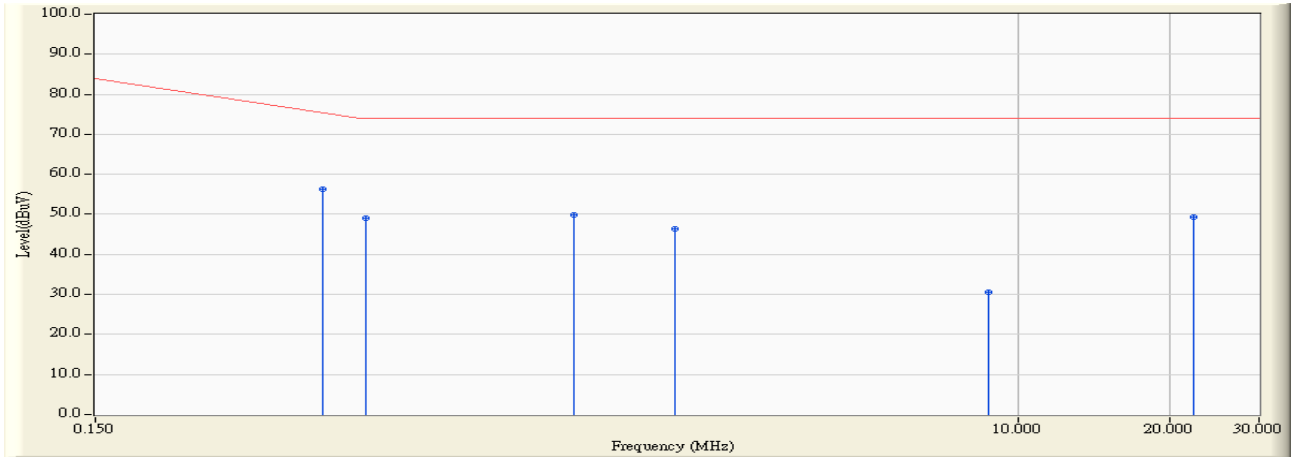

		Frequency (MHz)	Correct Factor (dB)	Reading Level (dBuV)	Measure Level (dBuV)	Margin (dB)	Limit (dBuV)	Detector Type
1	*	0.423	10.000	46.200	56.200	-20.000	76.200	AVERAGE
2		0.513	9.990	39.070	49.060	-24.940	74.000	AVERAGE
3		1.322	9.990	39.980	49.970	-24.030	74.000	AVERAGE
4		2.107	10.000	36.260	46.260	-27.740	74.000	AVERAGE
5		8.740	9.970	20.460	30.430	-43.570	74.000	AVERAGE
6		22.341	10.110	39.130	49.240	-24.760	74.000	AVERAGE

Note:

1. All Reading Levels are Quasi-Peak and average value.
2. " * ", means this data is the worst emission level.
3. Measurement Level = Reading Level + Correct Factor

Site : SR1	Time : 2010/03/16 - 14:53
Limit : ISN_Voltage_A_00M_QP	Margin : 10
EUT : Outdoor Network Camera	Probe : ISN_T4 - Line1
Power : AC 230V/50Hz	Note : Mode 1, ISN 100Mbps



Site : SR1	Time : 2010/03/16 - 14:54
Limit : ISN_Voltage_A_00M_QP	Margin : 0
EUT : Outdoor Network Camera	Probe : ISN_T4 - Line1
Power : AC 230V/50Hz	Note : Mode 1, ISN 100Mbps

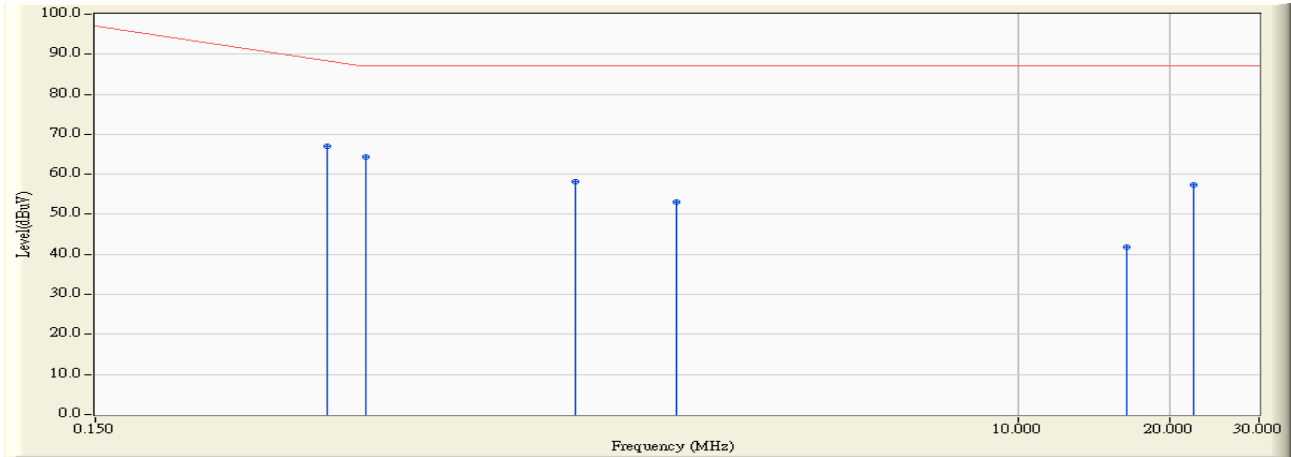

		Frequency (MHz)	Correct Factor (dB)	Reading Level (dBuV)	Measure Level (dBuV)	Margin (dB)	Limit (dBuV)	Detector Type
1	*	0.431	10.000	57.070	67.070	-21.901	88.971	QUASIPeAK
2		0.513	9.990	54.400	64.390	-22.610	87.000	QUASIPeAK
3		1.337	9.990	48.150	58.140	-28.860	87.000	QUASIPeAK
4		2.111	10.000	43.010	53.010	-33.990	87.000	QUASIPeAK
5		16.478	10.130	31.690	41.820	-45.180	87.000	QUASIPeAK
6		22.337	10.110	47.150	57.260	-29.740	87.000	QUASIPeAK

Note:

1. All Reading Levels are Quasi-Peak and average value.
2. " * ", means this data is the worst emission level.
3. Measurement Level = Reading Level + Correct Factor

Site : SR1	Time : 2010/03/16 - 14:54
Limit : ISN_Voltage_A_00M_AV	Margin : 0
EUT : Outdoor Network Camera	Probe : ISN_T4 - Line1
Power : AC 230V/50Hz	Note : Mode 1, ISN 100Mbps

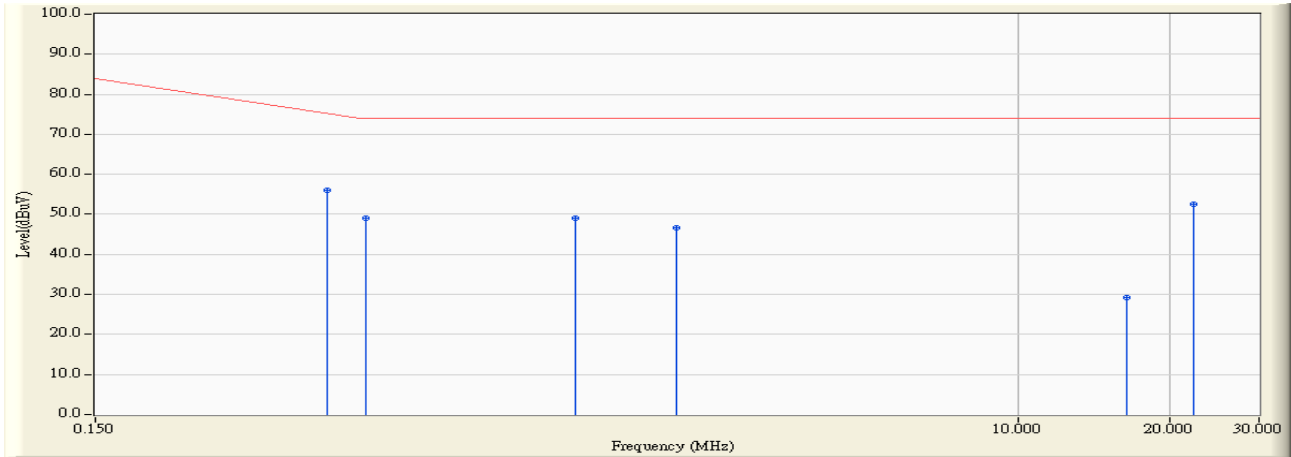

		Frequency (MHz)	Correct Factor (dB)	Reading Level (dBuV)	Measure Level (dBuV)	Margin (dB)	Limit (dBuV)	Detector Type
1	*	0.431	10.000	46.080	56.080	-19.891	75.971	AVERAGE
2		0.513	9.990	39.130	49.120	-24.880	74.000	AVERAGE
3		1.337	9.990	39.180	49.170	-24.830	74.000	AVERAGE
4		2.111	10.000	36.570	46.570	-27.430	74.000	AVERAGE
5		16.478	10.130	19.140	29.270	-44.730	74.000	AVERAGE
6		22.337	10.110	42.550	52.660	-21.340	74.000	AVERAGE

Note:

1. All Reading Levels are Quasi-Peak and average value.
2. " * ", means this data is the worst emission level.
3. Measurement Level = Reading Level + Correct Factor

Site : SR1	Time : 2010/03/16 - 15:25
Limit : CISPR_A_00M_QP	Margin : 10
EUT : Outdoor Network Camera	Probe : CVP-2200A - Line1
Power : By PoE	Note : Mode 2, ISN 10Mbps



Site : SR1	Time : 2010/03/16 - 15:28
Limit : CISPR_A_00M_QP	Margin : 0
EUT : Outdoor Network Camera	Probe : CVP-2200A - Line1
Power : By PoE	Note : Mode 2, ISN 10Mbps

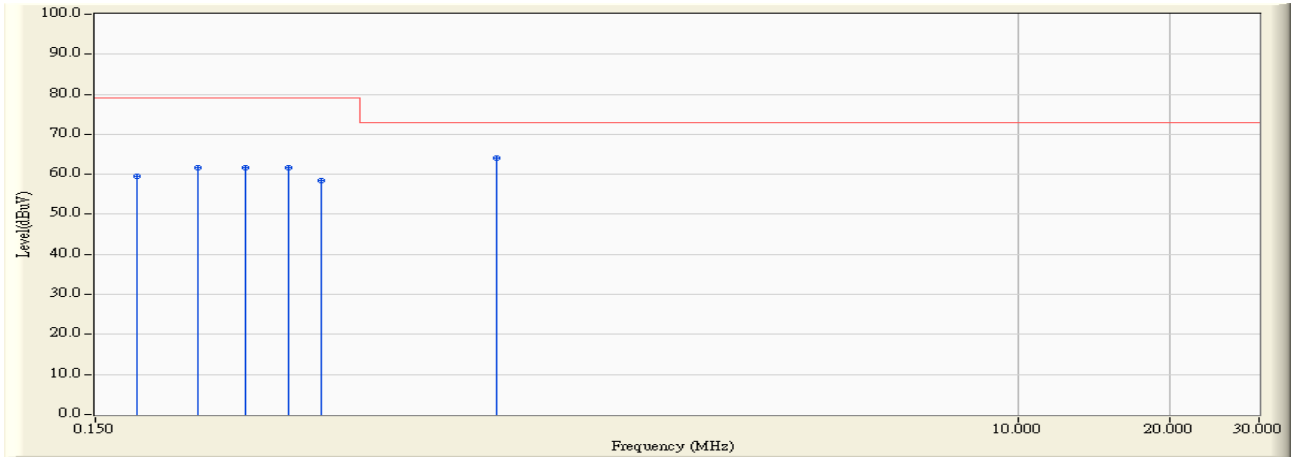

		Frequency (MHz)	Correct Factor (dB)	Reading Level (dBuV)	Measure Level (dBuV)	Margin (dB)	Limit (dBuV)	Detector Type
1		0.181	20.200	39.450	59.650	-19.350	79.000	QUASIPeAK
2		0.240	20.200	41.590	61.790	-17.210	79.000	QUASIPeAK
3		0.298	20.200	41.470	61.670	-17.330	79.000	QUASIPeAK
4		0.361	20.200	41.590	61.790	-17.210	79.000	QUASIPeAK
5		0.420	20.200	38.270	58.470	-20.530	79.000	QUASIPeAK
6	*	0.933	20.200	43.870	64.070	-8.930	73.000	QUASIPeAK

Note:

1. All Reading Levels are Quasi-Peak and average value.
2. " * ", means this data is the worst emission level.
3. Measurement Level = Reading Level + Correct Factor

Site : SR1	Time : 2010/03/16 - 15:28
Limit : CISPR_A_00M_AV	Margin : 0
EUT : Outdoor Network Camera	Probe : CVP-2200A - Line1
Power : By PoE	Note : Mode 2, ISN 10Mbps

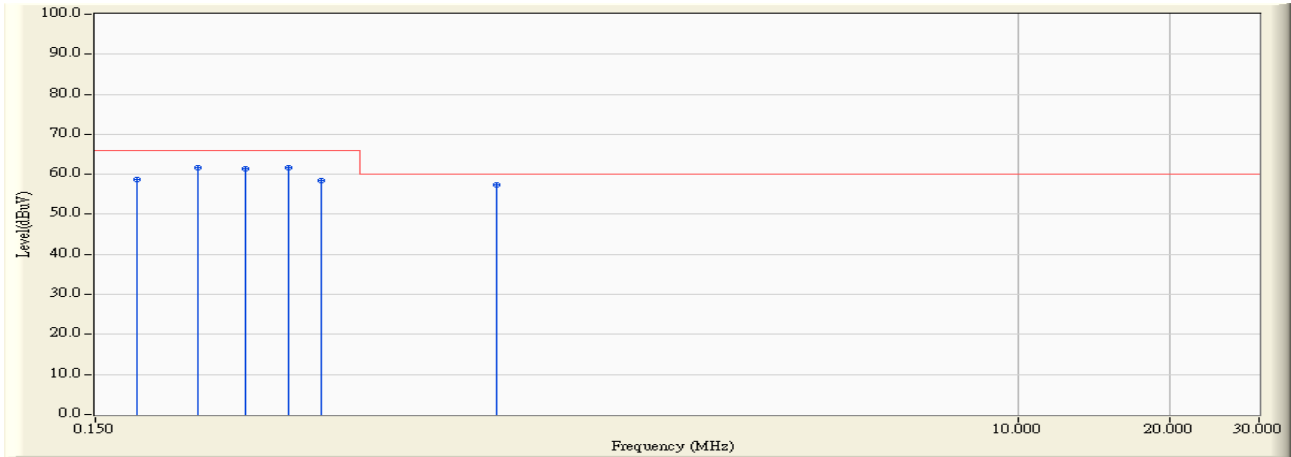

		Frequency (MHz)	Correct Factor (dB)	Reading Level (dBuV)	Measure Level (dBuV)	Margin (dB)	Limit (dBuV)	Detector Type
1		0.181	20.200	38.520	58.720	-7.280	66.000	AVERAGE
2		0.240	20.200	41.560	61.760	-4.240	66.000	AVERAGE
3		0.298	20.200	41.180	61.380	-4.620	66.000	AVERAGE
4		0.361	20.200	41.360	61.560	-4.440	66.000	AVERAGE
5		0.420	20.200	38.170	58.370	-7.630	66.000	AVERAGE
6	*	0.933	20.200	37.240	57.440	-2.560	60.000	AVERAGE

Note:

1. All Reading Levels are Quasi-Peak and average value.
2. " * ", means this data is the worst emission level.
3. Measurement Level = Reading Level + Correct Factor

Site : SR1	Time : 2010/03/16 - 15:17
Limit : CISPR_A_00M_QP	Margin : 10
EUT : Outdoor Network Camera	Probe : CVP-2200A - Line1
Power : By PoE	Note : Mode 2, ISN 100Mbps

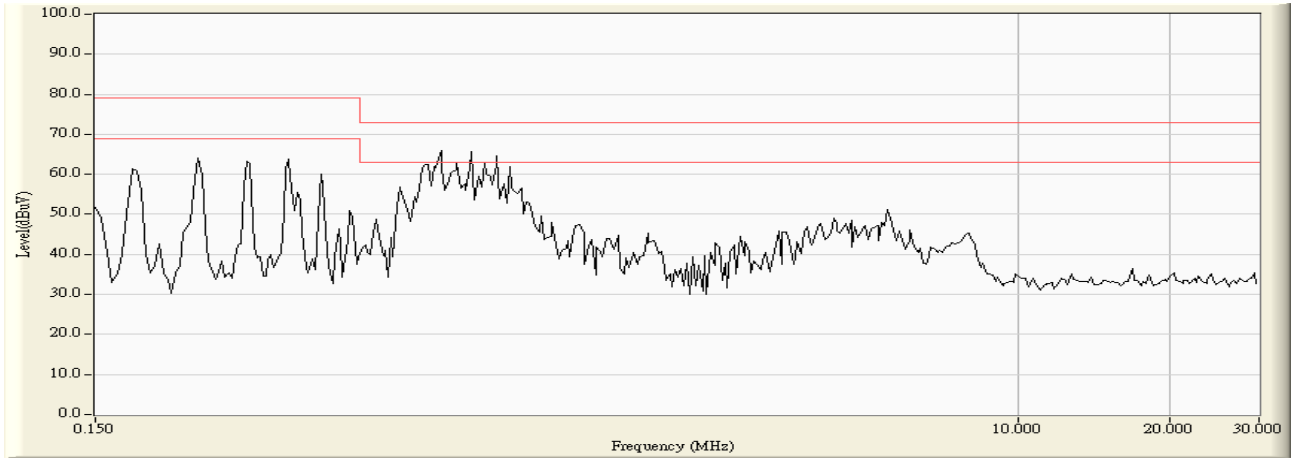

Site : SR1	Time : 2010/03/16 - 15:19
Limit : CISPR_A_00M_QP	Margin : 0
EUT : Outdoor Network Camera	Probe : CVP-2200A - Line1
Power : By PoE	Note : Mode 2, ISN 100Mbps

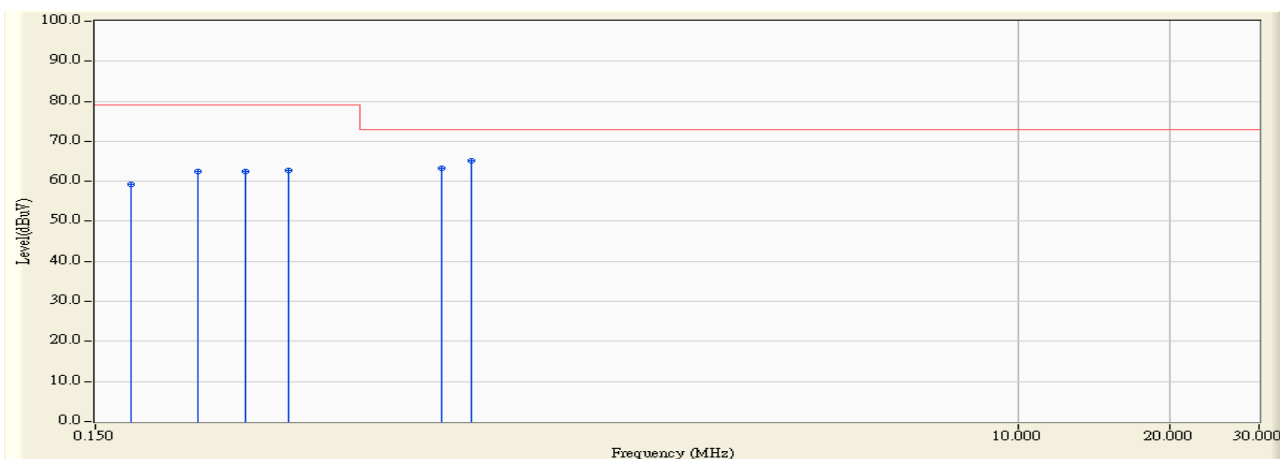

		Frequency (MHz)	Correct Factor (dB)	Reading Level (dBuV)	Measure Level (dBuV)	Margin (dB)	Limit (dBuV)	Detector Type
1		0.177	20.200	38.990	59.190	-19.810	79.000	QUASIPeAK
2		0.240	20.200	42.370	62.570	-16.430	79.000	QUASIPeAK
3		0.298	20.200	42.350	62.550	-16.450	79.000	QUASIPeAK
4		0.361	20.200	42.610	62.810	-16.190	79.000	QUASIPeAK
5		0.724	20.200	43.100	63.300	-9.700	73.000	QUASIPeAK
6	*	0.830	20.200	45.080	65.280	-7.720	73.000	QUASIPeAK

Note:

1. All Reading Levels are Quasi-Peak and average value.
2. " * ", means this data is the worst emission level.
3. Measurement Level = Reading Level + Correct Factor

Site : SR1	Time : 2010/03/16 - 15:19
Limit : CISPR_A_00M_AV	Margin : 0
EUT : Outdoor Network Camera	Probe : CVP-2200A - Line1
Power : By PoE	Note : Mode 2, ISN 100Mbps

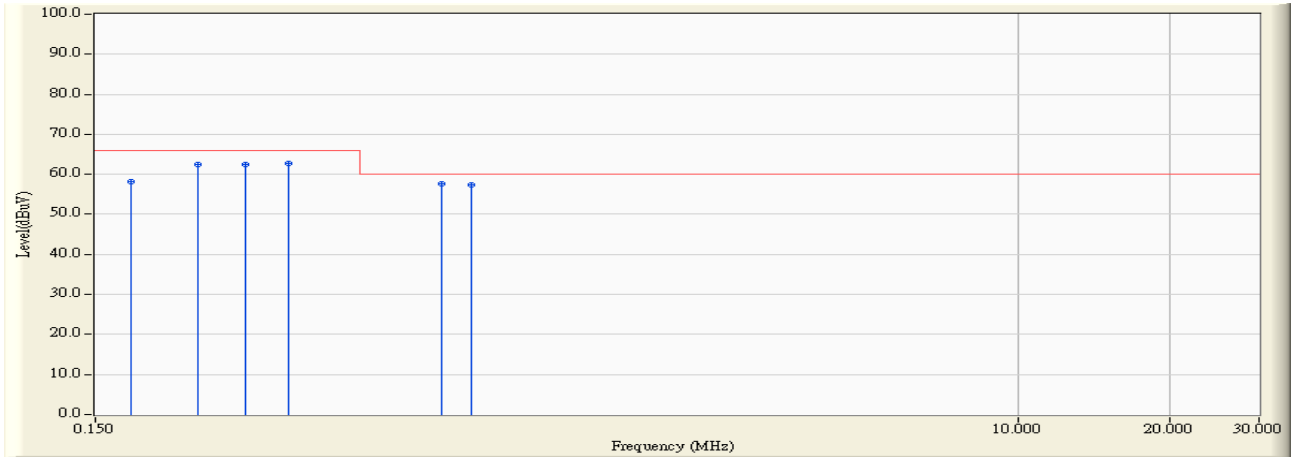

		Frequency (MHz)	Correct Factor (dB)	Reading Level (dBuV)	Measure Level (dBuV)	Margin (dB)	Limit (dBuV)	Detector Type
1		0.177	20.200	38.010	58.210	-7.790	66.000	AVERAGE
2		0.240	20.200	42.280	62.480	-3.520	66.000	AVERAGE
3		0.298	20.200	42.160	62.360	-3.640	66.000	AVERAGE
4		0.361	20.200	42.430	62.630	-3.370	66.000	AVERAGE
5	*	0.724	20.200	37.310	57.510	-2.490	60.000	AVERAGE
6		0.830	20.200	37.100	57.300	-2.700	60.000	AVERAGE

Note:

1. All Reading Levels are Quasi-Peak and average value.
2. " * ", means this data is the worst emission level.
3. Measurement Level = Reading Level + Correct Factor

4.7. Test Photograph

Test Mode : Mode 1: Normal Operation (Adapter)

Description : Front View of ISN Test



Test Mode : Mode 1: Normal Operation (Adapter)

Description : Back View of ISN Test



Test Mode : Mode 2: Normal Operation (PoE)

Description : Front View of ISN Test



Test Mode : Mode 2: Normal Operation (PoE)

Description : Back View of ISN Test



5. Radiated Emission

5.1. Test Specification

According to EMC Standard : EN 55022 and AS/NZS CISPR 22

5.2. Test Setup

Under 1GHz Test Setup:

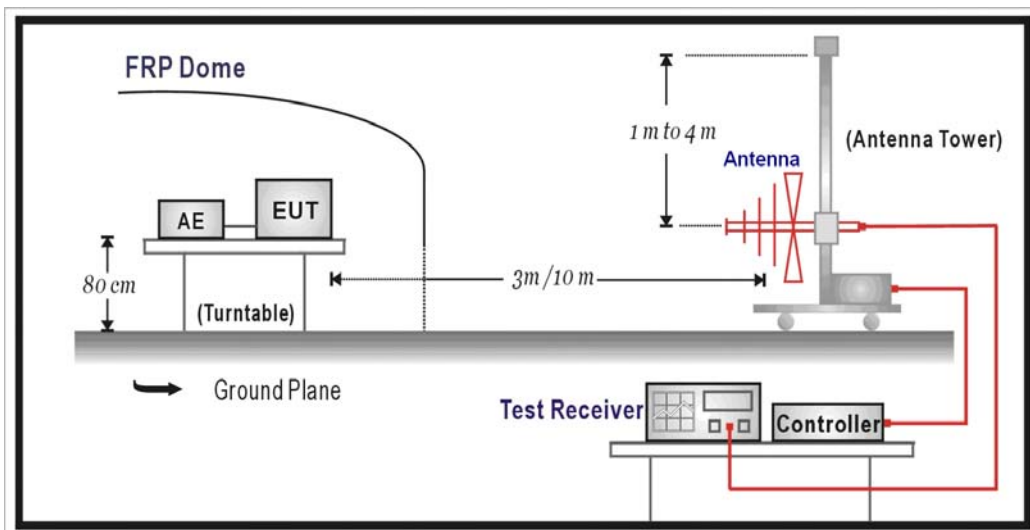

Above 1GHz Test Setup:

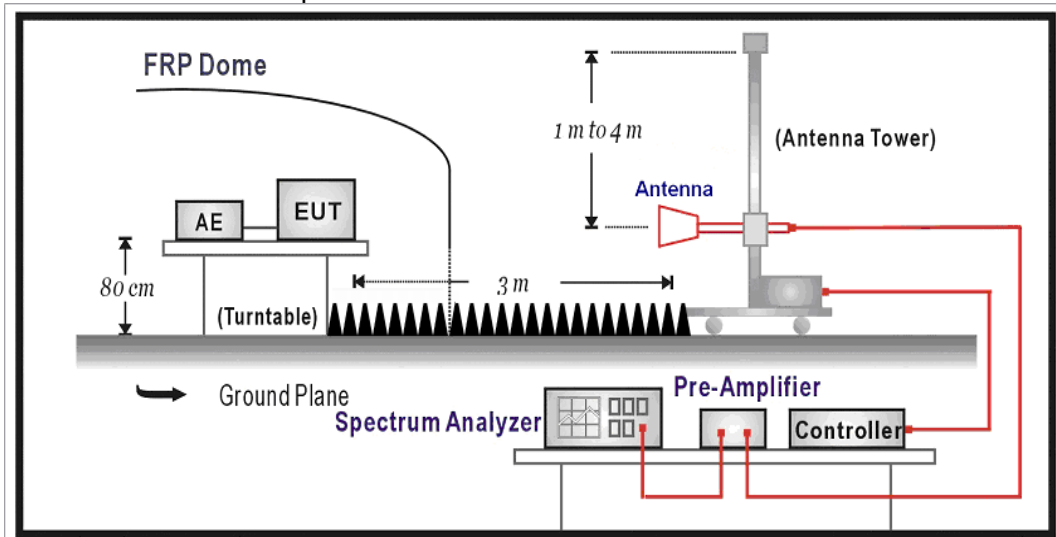

5.3. Limit

Limits		
Frequency MHz	Distance (m)	dBuV/m
30 – 230	10	40
230 – 1000	10	47

Limits			
Frequency (GHz)	Distance (m)	Peak (dBuV/m)	Average (dBuV/m)
1 – 3	3	76	56
3 – 6	3	80	60

Remark:

1. The tighter limit shall apply at the edge between two frequency bands.
2. Distance refers to the distance in meters between the measuring instrument antenna and the closed point of any part of the device or system.

Highest frequency generated or used in the device or on which the device operates or tunes (MHz)	Upper frequency of measurement range (MHz)
Below 108	1000
108 – 500	2000
500 – 1000	5000
Above 1000	5 th harmonic of the highest frequency or 6 GHz, whichever is lower

5.4. Test Procedure

The EUT and its simulators are placed on a turn table which is 0.8 meter above ground. The turn table can rotate 360 degrees to determine the position of the maximum emission level. The EUT was positioned such that the distance from antenna to the EUT was 3/10 meters. The antenna can move up and down between 1 meter and 4 meters to find out the maximum emission level.

Both horizontal and vertical polarization of the antenna are set on measurement. In order to find the maximum emission, all of the interface cables must be manipulated on radiated measurement.

Radiated emissions were investigated over the frequency range from 30MHz to 1GHz using a receiver bandwidth of 120kHz and above 1GHz using a receiver bandwidth of 1MHz.

30MHz to 1GHz Radiated was performed at an antenna to EUT distance of 10 meters.

Above 1GHz Radiated was performed at an antenna to EUT distance of 3 meters.

It is placed with absorb on the ground between EUT and Antenna.

5.5. Deviation from Test Standard

No deviation.

5.6. Test Result

Site : OATS-6	Time : 2010/03/15 - 15:29
Limit : CISPR_A_10M_QP	Margin : 6
EUT : Outdoor Network Camera	Probe : Site6_CBL6112_0811_10m - HORIZONTAL
Power : AC 230V/50Hz	Note : Mode 1

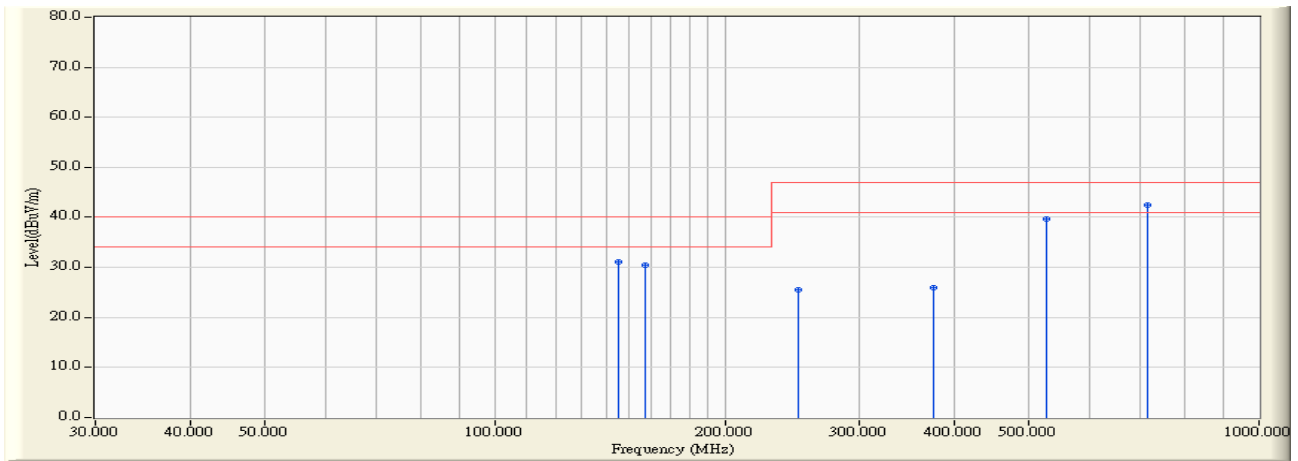

	Frequency (MHz)	Correct Factor (dB)	Reading Level (dBuV)	Measure Level (dBuV/m)	Margin (dB)	Limit (dBuV/m)	Detector Type
1	145.266	13.772	17.300	31.072	-8.928	40.000	QUASIPeAK
2	157.542	12.972	17.400	30.372	-9.628	40.000	QUASIPeAK
3	250.011	15.484	10.000	25.484	-21.516	47.000	QUASIPeAK
4	375.021	20.865	5.000	25.865	-21.135	47.000	QUASIPeAK
5	526.514	24.524	15.200	39.724	-7.276	47.000	QUASIPeAK
6	* 715.513	26.603	15.800	42.403	-4.597	47.000	QUASIPeAK

Note:

1. All Readings below 1GHz are Quasi-Peak, above are performed with peak and/or average measurements as necessary.
2. " * ", means this data is the worst emission level.
3. Measurement Level = Reading Level + Correct Factor

Site : OATS-6	Time : 2010/03/15 - 15:52
Limit : CISPR_A_10M_QP	Margin : 6
EUT : Outdoor Network Camera	Probe : Site6_CBL6112_0811_10m - VERTICAL
Power : AC 230V/50Hz	Note : Mode 1

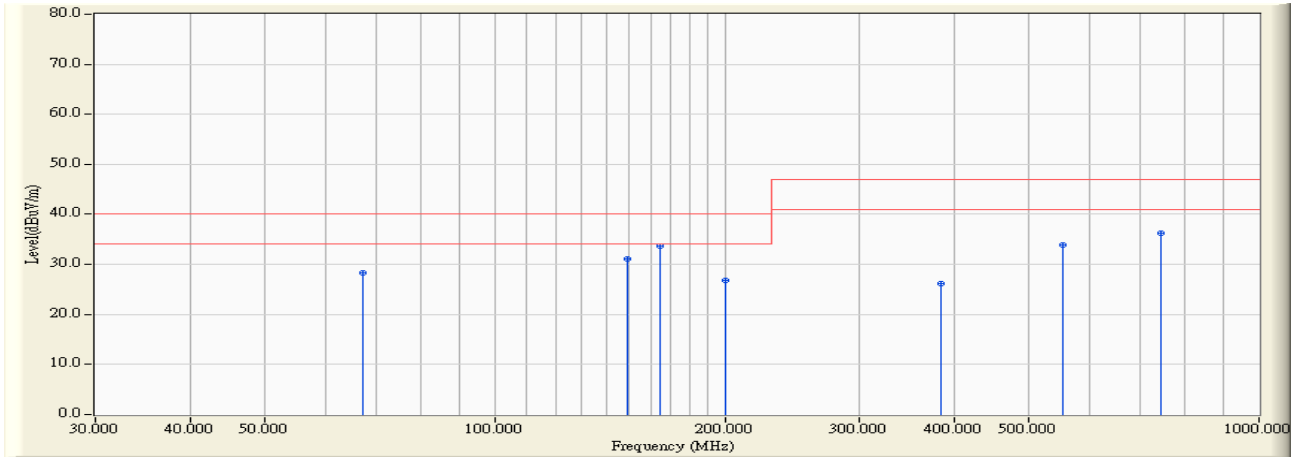

	Frequency (MHz)	Correct Factor (dB)	Reading Level (dBuV)	Measure Level (dBuV/m)	Margin (dB)	Limit (dBuV/m)	Detector Type
1	67.172	11.349	17.000	28.349	-11.651	40.000	QUASPEAK
2	149.356	16.971	14.100	31.072	-8.928	40.000	QUASPEAK
3	* 164.671	13.931	19.700	33.631	-6.369	40.000	QUASPEAK
4	200.011	13.470	13.400	26.870	-13.130	40.000	QUASPEAK
5	384.000	19.996	6.100	26.096	-20.904	47.000	QUASPEAK
6	553.504	25.242	8.600	33.842	-13.158	47.000	QUASPEAK
7	742.504	26.739	9.500	36.240	-10.760	47.000	QUASPEAK

Note:

1. All Readings below 1GHz are Quasi-Peak, above are performed with peak and/or average measurements as necessary.
2. " * ", means this data is the worst emission level.
3. Measurement Level = Reading Level + Correct Factor

Site : OATS-6	Time : 2010/03/15 - 15:00
Limit : CISPR_A_10M_QP	Margin : 6
EUT : Outdoor Network Camera	Probe : Site6_CBL6112_0811_10m - HORIZONTAL
Power : By PoE	Note : Mode 2

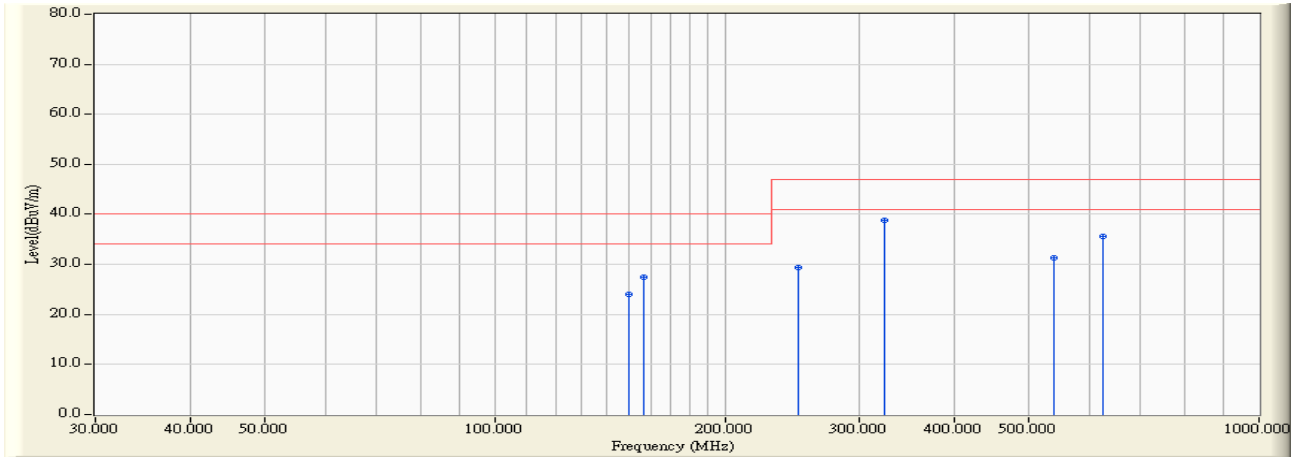

		Frequency (MHz)	Correct Factor (dB)	Reading Level (dBuV)	Measure Level (dBuV/m)	Margin (dB)	Limit (dBuV/m)	Detector Type
1		149.473	13.690	10.400	24.090	-15.910	40.000	QUASPEAK
2		156.577	13.121	14.400	27.521	-12.479	40.000	QUASPEAK
3		250.008	15.484	13.900	29.384	-17.616	47.000	QUASPEAK
4	*	323.993	19.997	18.900	38.897	-8.103	47.000	QUASPEAK
5		540.003	25.162	6.200	31.362	-15.638	47.000	QUASPEAK
6		625.032	25.861	9.700	35.561	-11.439	47.000	QUASPEAK

Note:

1. All Readings below 1GHz are Quasi-Peak, above are performed with peak and/or average measurements as necessary.
2. " * ", means this data is the worst emission level.
3. Measurement Level = Reading Level + Correct Factor

Site : OATS-6	Time : 2010/03/15 - 14:40
Limit : CISPR_A_10M_QP	Margin : 6
EUT : Outdoor Network Camera	Probe : Site6_CBL6112_0811_10m - VERTICAL
Power : By PoE	Note : Mode 2

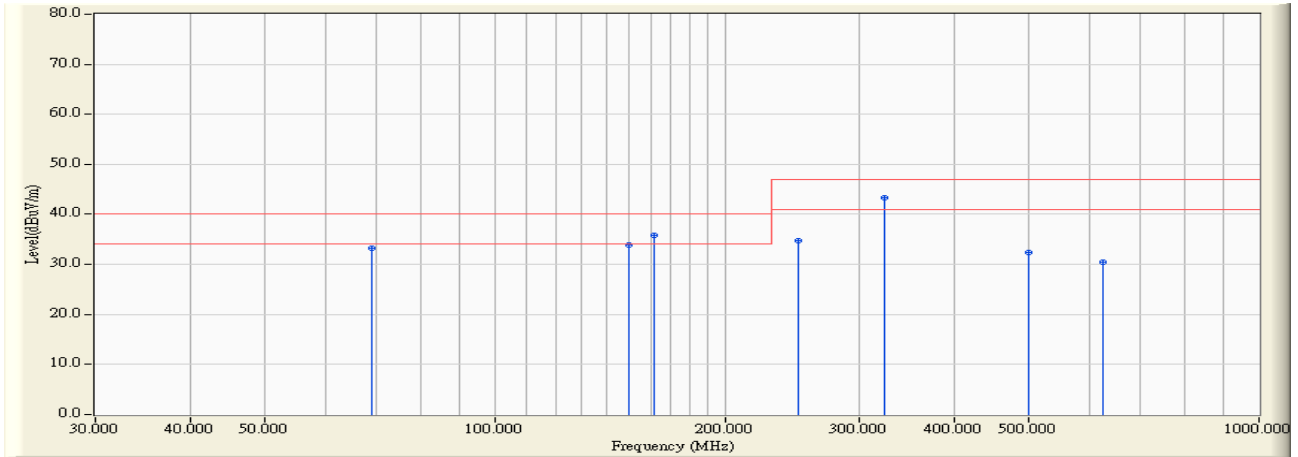

	Frequency (MHz)	Correct Factor (dB)	Reading Level (dBuV)	Measure Level (dBuV/m)	Margin (dB)	Limit (dBuV/m)	Detector Type
1	69.010	10.888	22.300	33.188	-6.812	40.000	QUASIPeAK
2	149.552	16.979	16.900	33.880	-6.120	40.000	QUASIPeAK
3	161.841	14.588	21.200	35.789	-4.211	40.000	QUASIPeAK
4	250.010	16.813	17.900	34.713	-12.287	47.000	QUASIPeAK
5	* 323.996	17.940	25.300	43.240	-3.760	47.000	QUASIPeAK
6	500.021	24.466	8.000	32.466	-14.534	47.000	QUASIPeAK
7	625.032	22.903	7.500	30.404	-16.596	47.000	QUASIPeAK

Note:

1. All Readings below 1GHz are Quasi-Peak, above are performed with peak and/or average measurements as necessary.
2. " * ", means this data is the worst emission level.
3. Measurement Level = Reading Level + Correct Factor

5.7. Test Photograph

Test Mode : Mode 1: Normal Operation (Adapter)

Description : Front View of Radiated Test



Test Mode : Mode 1: Normal Operation (Adapter)

Description : Back View of Radiated Test



Test Mode : Mode 2: Normal Operation (PoE)

Description : Front View of Radiated Test



Test Mode : Mode 2: Normal Operation (PoE)

Description : Back View of Radiated Test



6. Harmonic Current Emission

6.1. Test Specification

According to EMC Standard : EN 61000-3-2

6.2. Test Setup

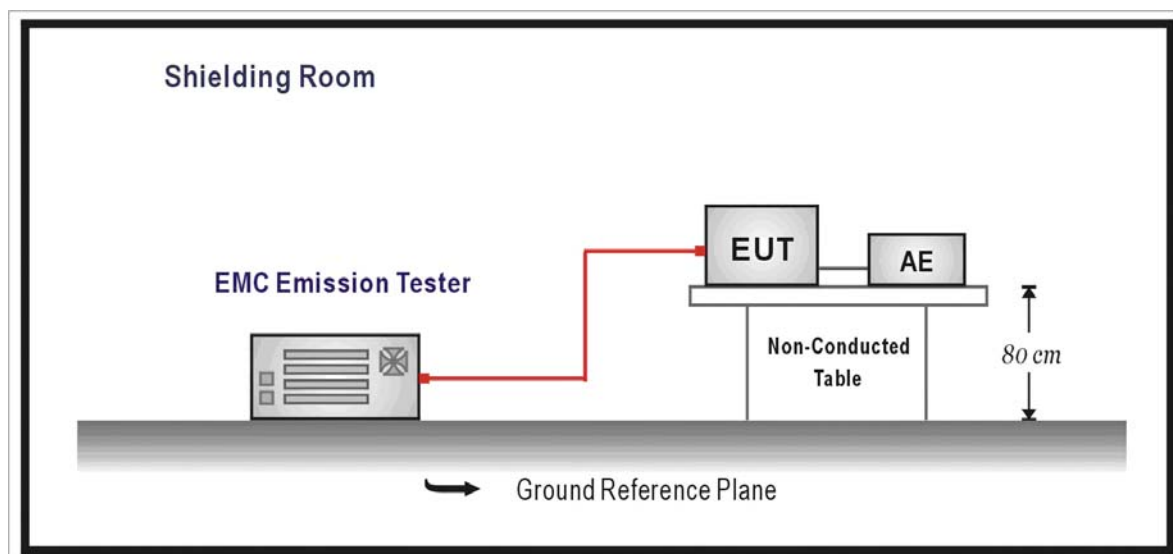

6.3. Limit

(a) Limits of Class A Harmonics Currents

Harmonics Order n	Maximum Permissible harmonic current A	Harmonics Order n	Maximum Permissible harmonic current A
Odd harmonics		Even harmonics	
3	2.30	2	1.08
5	1.14	4	0.43
7	0.77	6	0.30
9	0.40	$8 \leq n \leq 40$	$0.23 * 8/n$
11	0.33		
13	0.21		
$15 \leq n \leq 39$	$0.15 * 15/n$		

(b) Limits of Class B Harmonics Currents

For Class B equipment, the harmonic of the input current shall not exceed the maximum permissible values given in table that is the limit of Class A multiplied by a factor of 1.5.

(c) Limits of Class C Harmonics Currents

Harmonics Order n	Maximum Permissible harmonic current Expressed as a percentage of the input current at the fundamental frequency %
2	2
3	$30 \cdot \lambda^*$
5	10
7	7
9	5
$11 \leq n \leq 39$ (odd harmonics only)	3

* λ is the circuit power factor

(d) Limits of Class D Harmonics Currents

Harmonics Order n	Maximum Permissible harmonic current per watt mA/W	Maximum Permissible harmonic current A
3	3.4	2.30
5	1.9	1.14
7	1.0	0.77
9	0.5	0.40
11	0.35	0.33
$11 \leq n \leq 39$ (odd harmonics only)	$3.85/n$	See limit of Class A

6.4. Test Procedure

The EUT is supplied in series with power analyzer from a power source having the same normal voltage and frequency as the rated supply voltage and the equipment under test. And the rated voltage at the supply voltage of EUT of 0.94 times and 1.06 times shall be performed.

6.5. Deviation from Test Standard

No deviation.

6.6. Test Result

Product	Outdoor Network Camera		
Test Item	Power Harmonics		
Test Mode	Mode 1: Normal Operation (Adapter)		
Date of Test	2010/03/17	Test Site	No.3 Shielded Room

Test Result: Pass Source qualification: Normal

Current & voltage waveforms

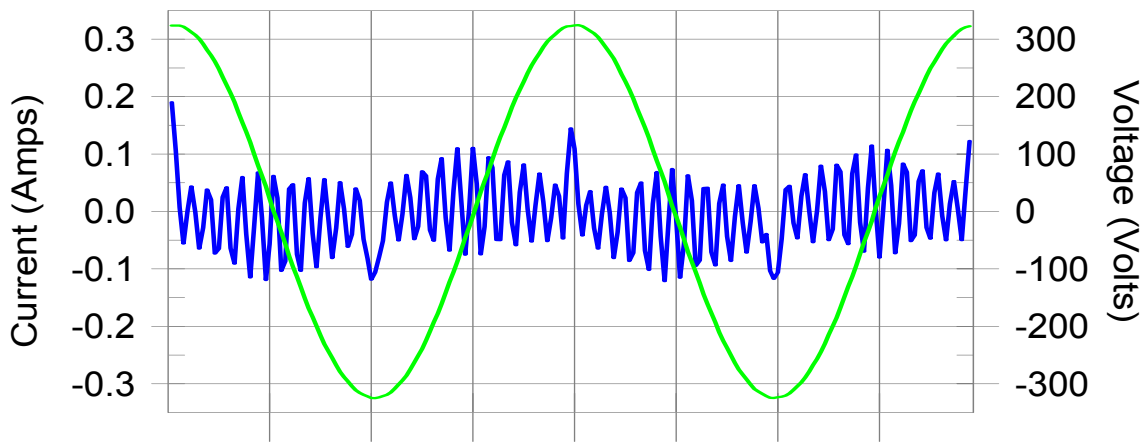

Harmonics and Class A limit line

European Limits

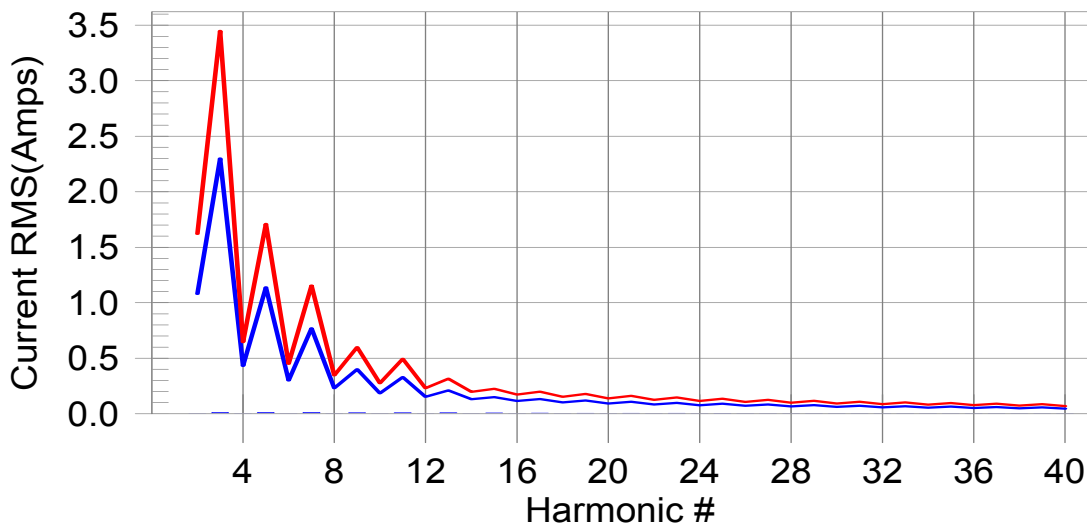

Test result: Pass Worst harmonic was #15 with 4.34% of the limit.

Test Result: Pass Source qualification: Normal
 THC(A): 0.02 I-THD(%): 132.98 POHC(A): 0.007 POHC Limit(A): 0.251
 Highest parameter values during test:

V_RMS (Volts):	229.63	Frequency(Hz):	50.00
I_Peak (Amps):	0.190	I_RMS (Amps):	0.061
I_Fund (Amps):	0.019	Crest Factor:	3.120
Power (Watts):	2.5	Power Factor:	0.177

Harm#	Harms(avg)	100%Limit	%of Limit	Harms(max)	150%Limit	%of Limit	Status
2	0.001	1.080	0.1	0.001	1.620	0.04	Pass
3	0.010	2.300	0.4	0.010	3.450	0.30	Pass
4	0.001	0.430	0.1	0.001	0.645	0.10	Pass
5	0.010	1.140	0.8	0.010	1.710	0.57	Pass
6	0.001	0.300	0.2	0.001	0.450	0.15	Pass
7	0.009	0.770	1.2	0.009	1.155	0.81	Pass
8	0.001	0.230	0.2	0.001	0.345	0.18	Pass
9	0.009	0.400	2.2	0.009	0.600	1.48	Pass
10	0.001	0.184	0.3	0.001	0.276	0.21	Pass
11	0.008	0.330	2.4	0.008	0.495	1.65	Pass
12	0.001	0.153	0.3	0.001	0.230	0.28	Pass
13	0.007	0.210	3.5	0.007	0.315	2.36	Pass
14	0.000	0.131	0.4	0.001	0.197	0.28	Pass
15	0.007	0.150	4.3	0.007	0.225	2.96	Pass
16	0.000	0.115	0.4	0.001	0.173	0.30	Pass
17	0.006	0.132	4.3	0.006	0.199	2.92	Pass
18	0.000	0.102	0.4	0.001	0.153	0.34	Pass
19	0.005	0.118	4.1	0.005	0.178	2.82	Pass
20	0.000	0.092	0.4	0.000	0.138	0.33	Pass
21	0.004	0.107	3.8	0.004	0.161	2.59	Pass
22	0.000	0.084	0.4	0.000	0.125	0.33	Pass
23	0.003	0.098	3.4	0.003	0.147	2.33	Pass
24	0.000	0.077	0.4	0.000	0.115	0.34	Pass
25	0.003	0.090	2.9	0.003	0.135	1.98	Pass
26	0.000	0.071	0.4	0.000	0.106	0.32	Pass
27	0.002	0.083	2.4	0.002	0.125	1.63	Pass
28	0.000	0.066	0.4	0.000	0.099	0.31	Pass
29	0.001	0.078	1.8	0.001	0.116	1.29	Pass
30	0.000	0.061	0.4	0.000	0.092	0.40	Pass
31	0.001	0.073	1.4	0.001	0.109	0.96	Pass
32	0.000	0.058	0.3	0.000	0.086	0.30	Pass
33	0.001	0.068	1.0	0.001	0.102	0.70	Pass
34	0.000	0.054	0.3	0.000	0.081	0.26	Pass
35	0.001	0.064	0.8	0.001	0.096	0.61	Pass
36	0.000	0.051	0.3	0.000	0.077	0.25	Pass
37	0.001	0.061	0.9	0.001	0.091	0.62	Pass
38	0.000	0.048	0.3	0.000	0.073	0.24	Pass
39	0.001	0.058	1.0	0.001	0.087	0.70	Pass
40	0.000	0.046	0.3	0.000	0.069	0.27	Pass

1. Dynamic limits were applied for this test. The highest harmonics values in the above table may not occur at the same window as the maximum harmonics/limit ratio.

2: According to EN61000-3-2 paragraph 7 the note 1 and 2 are valid for all applications having an active input power >75W. Others the result should be pass.

6.7. Test Photograph

Test Mode : Mode 1: Normal Operation (Adapter)

Description : Power Harmonics Test Setup



7. Voltage Fluctuation and Flicker

7.1. Test Specification

According to EMC Standard : EN 61000-3-3

7.2. Test Setup

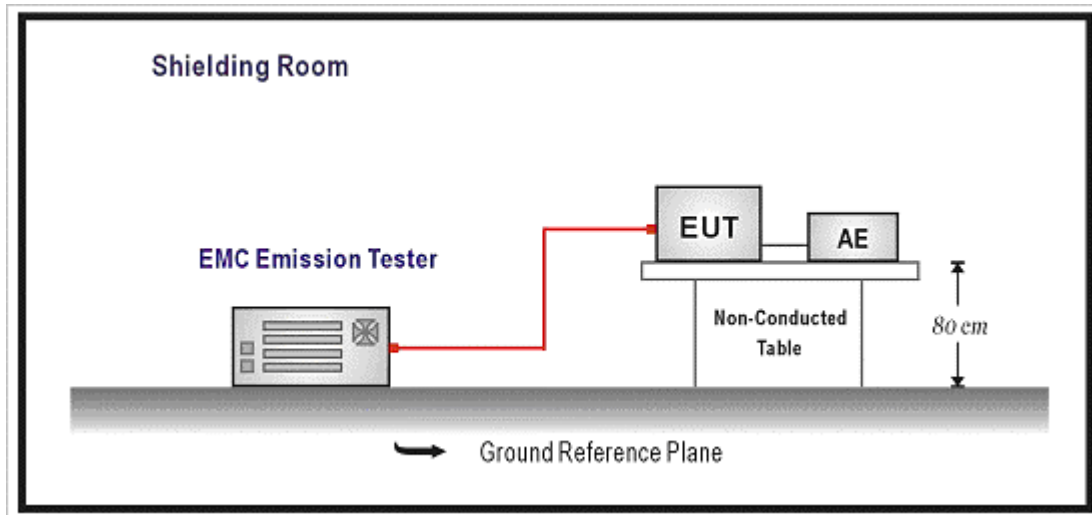

7.3. Limit

The following limits apply:

- the value of P_{st} shall not be greater than 1.0;
- the value of P_{1t} shall not be greater than 0.65;
- the value of $d(t)$ during a voltage change shall not exceed 3.3 % for more than 500 ms;
- the relative steady-state voltage change, d_c , shall not exceed 3.3 %;
- the maximum relative voltage change, d_{max} , shall not exceed;
 - a) 4 % without additional conditions;
 - b) 6 % for equipment which is:
 - switched manually, or
 - switched automatically more frequently than twice per day, and also has either a delayed restart (the delay being not less than a few tens of seconds), or manual restart, after a power supply interruption.

NOTE The cycling frequency will be further limited by the P_{st} and P_{1t} limit.

For example: a d_{max} of 6% producing a rectangular voltage change characteristic twice per hour will give a P_{1t} of about 0.65.

- c) 7 % for equipment which is:
- attended whilst in use (for example: hair dryers, vacuum cleaners, kitchen equipment such as mixers, garden equipment such as lawn mowers, portable tools such as electric drills), or
 - switched on automatically, or is intended to be switched on manually, no more than twice per day, and also has either a delayed restart (the delay being not less than a few tens of seconds) or manual restart, after a power supply interruption.

P_{st} and P_{1t} requirements shall not be applied to voltage changes caused by manual switching.

7.4. Test Procedure

The EUT is supplied in series with power analyzer from a power source having the same normal voltage and frequency as the rated supply voltage and the equipment under test. And the rated voltage at the supply voltage of EUT of 0.94 times and 1.06 times shall be performed.

7.5. Deviation from Test Standard

No deviation.

7.6. Test Result

Product	Outdoor Network Camera		
Test Item	Voltage Fluctuation and Flicker		
Test Mode	Mode 1: Normal Operation (Adapter)		
Date of Test	2010/03/17	Test Site	No.3 Shielded Room

Test Result: Pass Status: Test Completed

Pstj and limit line

European Limits



Plt and limit line

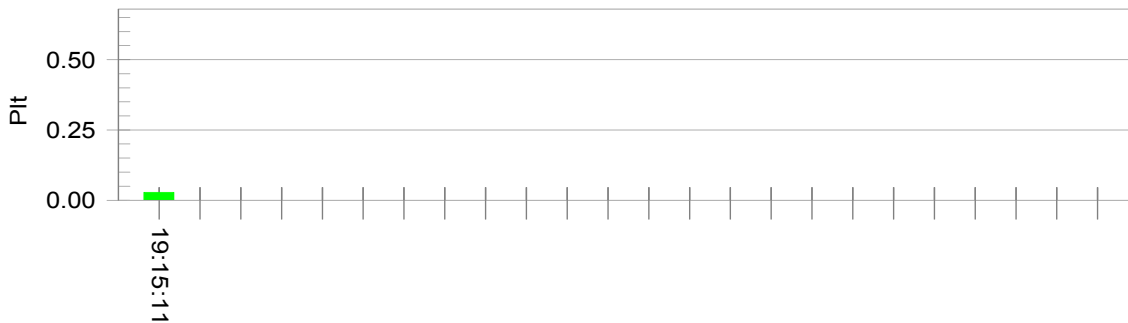

Parameter values recorded during the test:

Vrms at the end of test (Volt):	229.58		
Highest dt (%):	0.00	Test limit (%):	3.30 Pass
Time(mS) > dt:	0.0	Test limit (mS):	500.0 Pass
Highest dc (%):	0.00	Test limit (%):	3.30 Pass
Highest dmax (%):	0.00	Test limit (%):	4.00 Pass
Highest Pst (10 min. period):	0.064	Test limit:	1.000 Pass
Highest Plt (2 hr. period):	0.028	Test limit:	0.650 Pass

7.7. Test Photograph

Test Mode : Mode 1: Normal Operation (Adapter)

Description : Flicker Test Setup



8. Electrostatic Discharge

8.1. Test Specification

According to Standard : IEC 61000-4-2

8.2. Test Setup

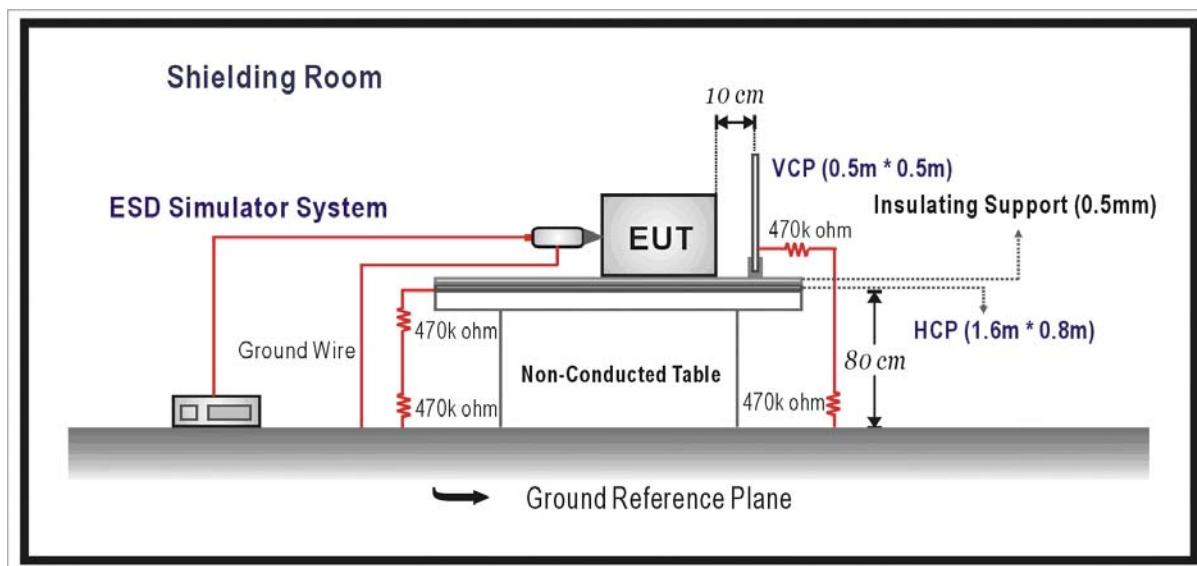

8.3. Limit

Item	Environmental Phenomena	Units	Test Specification	Performance Criteria
Enclosure Port				
	Electrostatic Discharge	kV(Charge Voltage)	±8 Air Discharge ±4 Contact Discharge	B

8.4. Test Procedure

Direct application of discharges to the EUT:

Contact discharge was applied only to conductive surfaces of the EUT.

Air discharges were applied only to non-conductive surfaces of the EUT.

During the test, it was performed with single discharges. For the single discharge time between successive single discharges will be keep longer 1 second. It was at least ten single discharges with positive and negative at the same selected point.

The selected point, which was performed with electrostatic discharge, was marked on the red label of the EUT.

Indirect application of discharges to the EUT:

Vertical Coupling Plane (VCP):

The coupling plane, of dimensions 0.5m x 0.5m, is placed parallel to, and positioned at a distance 0.1m from, the EUT, with the Discharge Electrode touching the coupling plane.

The four faces of the EUT will be performed with electrostatic discharge. It was at least ten single discharges with positive and negative at the same selected point.

Horizontal Coupling Plane (HCP):

The coupling plane is placed under to the EUT. The generator shall be positioned vertically at a distance of 0.1m from the EUT, with the Discharge Electrode touching the coupling plane.

The four faces of the EUT will be performed with electrostatic discharge. It was at least ten single discharges with positive and negative at the same selected point.

8.5. Deviation from Test Standard

No deviation.

8.6. Test Result

Product	Outdoor Network Camera		
Test Item	Electrostatic Discharge		
Test Mode	Mode 1: Normal Operation (Adapter)		
Date of Test	2010/03/18	Test Site	No.3 Shielded Room

Item	Amount of Discharge	Voltage	Required Criteria	Complied To Criteria (A,B,C)	Results
Air Discharge	10	+8kV	B	A	Pass
	10	-8kV	B	A	Pass
Contact Discharge	25	+4kV	B	A	Pass
	25	-4kV	B	A	Pass
Indirect Discharge (HCP)	25	+4kV	B	A	Pass
	25	-4kV	B	A	Pass
Indirect Discharge (VCP Front)	25	+4kV	B	A	Pass
	25	-4kV	B	A	Pass
Indirect Discharge (VCP Left)	25	+4kV	B	A	Pass
	25	-4kV	B	A	Pass
Indirect Discharge (VCP Back)	25	+4kV	B	A	Pass
	25	-4kV	B	A	Pass
Indirect Discharge (VCP Right)	25	+4kV	B	A	Pass
	25	-4kV	B	A	Pass

Note:

The testing performed is from lowest level up to the highest level as required by standard, but only highest level is shown on the report.

NR: No Requirement

- Meet criteria A: Operate as intended during and after the test
- Meet criteria B: Operate as intended after the test
- Meet criteria C: Loss/Error of function
- Additional Information
 - EUT stopped operation and could / could not be reset by operator at ____ kV.
 - No false alarms or other malfunctions were observed during or after the test.

Remark:

The Contact discharges were applied at least total 200 discharges at a minimum of four test points.

8.7. Test Photograph

Test Mode : Mode 1: Normal Operation (Adapter)

Description : ESD Test Setup

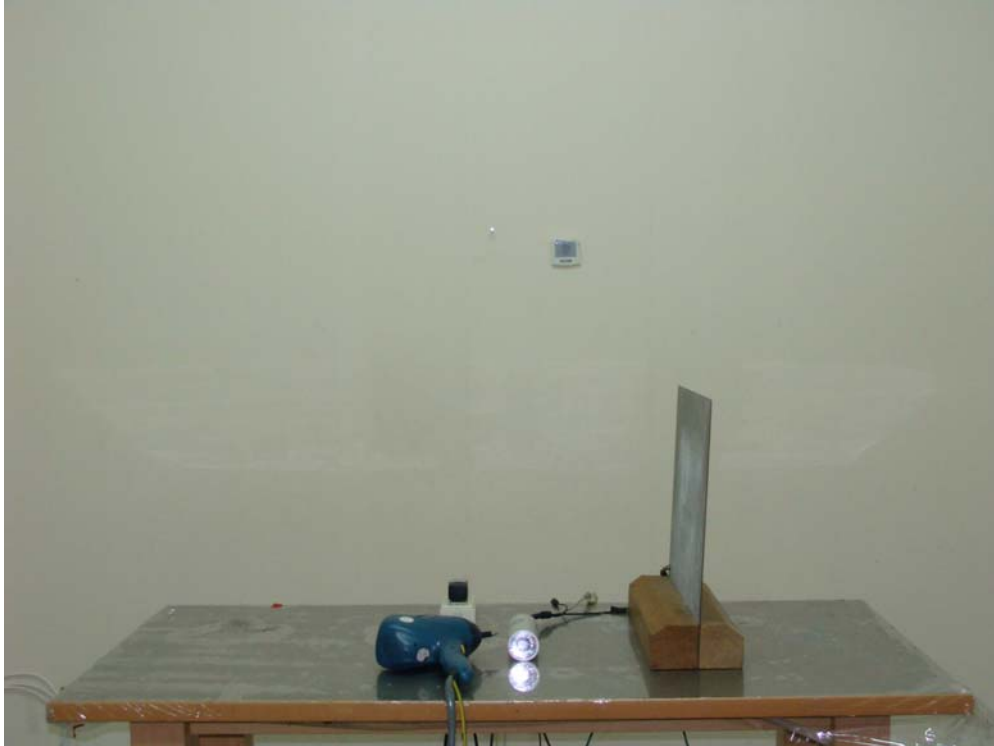

9. Radiated Susceptibility

9.1. Test Specification

According to Standard : IEC 61000-4-3

9.2. Test Setup

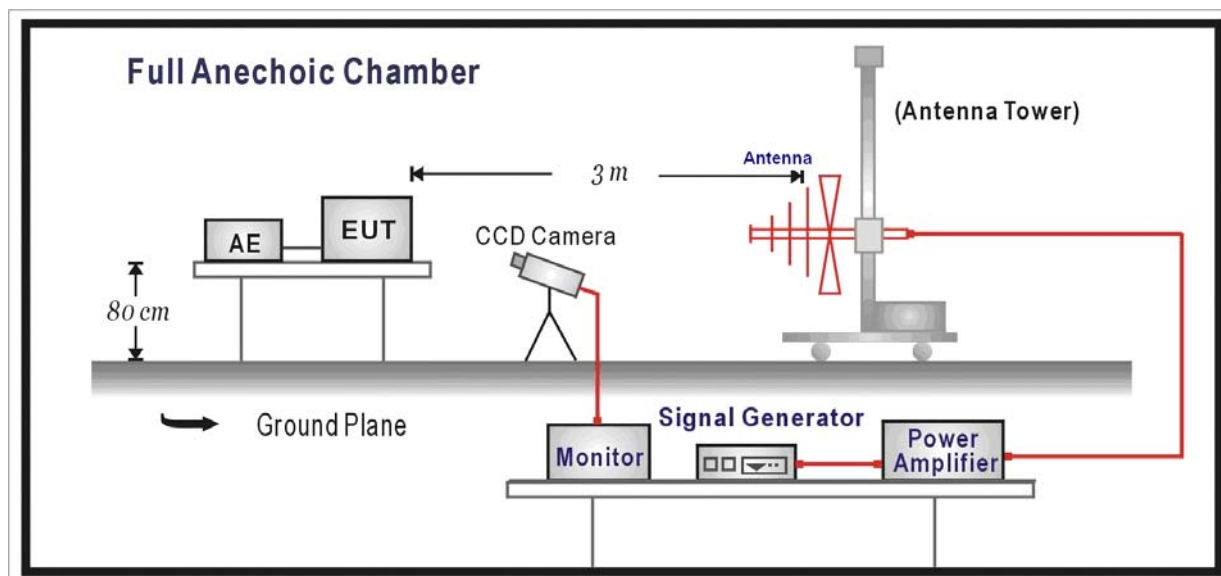

9.3. Limit

Item	Environmental Phenomena	Units	Test Specification	Performance Criteria
Enclosure Port				
	Radio-Frequency	MHz	80-1000	A
	Electromagnetic Field	V/m(Un-modulated, rms)	3	
	Amplitude Modulated	% AM (1kHz)	80	

9.4. Test Procedure

The EUT and load, which are placed on a table that is 0.8 meter above ground, are placed with one coincident with the calibration plane such that the distance from antenna to the EUT was 3 meters.

Both horizontal and vertical polarization of the antenna and four sides of the EUT are set on measurement.

In order to judge the EUT performance, a CCD camera is used to monitor EUT screen.

All the scanning conditions are as follows:

Condition of Test	Remarks
1. Field Strength	3 V/m Level 2
2. Radiated Signal	AM 80% Modulated with 1kHz
3. Scanning Frequency	80MHz - 1000MHz
4. Dwell Time	3 Seconds
5. Frequency step size Δf :	1%
6. The rate of Swept of Frequency	1.5×10^{-3} decades/s

9.5. Deviation from Test Standard

No deviation.

9.6. Test Result

Product	Outdoor Network Camera		
Test Item	Radiated susceptibility		
Test Mode	Mode 1: Normal Operation (Adapter)		
Date of Test	2010/03/18	Test Site	Chamber5

Frequency (MHz)	Position (Angle)	Polarity (H or V)	Field Strength (V/m)	Required Criteria	Complied To Criteria (A, B, C)	Results
80-1000	FRONT	H	3	A	A	PASS
80-1000	FRONT	V	3	A	A	PASS
80-1000	BACK	H	3	A	A	PASS
80-1000	BACK	V	3	A	A	PASS
80-1000	RIGHT	H	3	A	A	PASS
80-1000	RIGHT	V	3	A	A	PASS
80-1000	LEFT	H	3	A	A	PASS
80-1000	LEFT	V	3	A	A	PASS
80-1000	UP	H	3	A	A	PASS
80-1000	UP	V	3	A	A	PASS
80-1000	DOWN	H	3	A	A	PASS
80-1000	DOWN	V	3	A	A	PASS

Note:

The testing performed is from lowest level up to the highest level as required by standard, but only highest level is shown on the report.

- Meet criteria A: Operate as intended during and after the test
- Meet criteria B: Operate as intended after the test
- Meet criteria C: Loss/Error of function
- Additional Information
 - There was no observable degradation in performance.
 - EUT stopped operation and could / could not be reset by operator at _____ V/m at frequency _____ MHz.
- No false alarms or other malfunctions were observed during or after the test.

9.7. Test Photograph

Test Mode : Mode 1: Normal Operation (Adapter)

Description : Radiated Susceptibility Test Setup



10. Electrical Fast Transient/Burst

10.1. Test Specification

According to Standard : IEC 61000-4-4

10.2. Test Setup

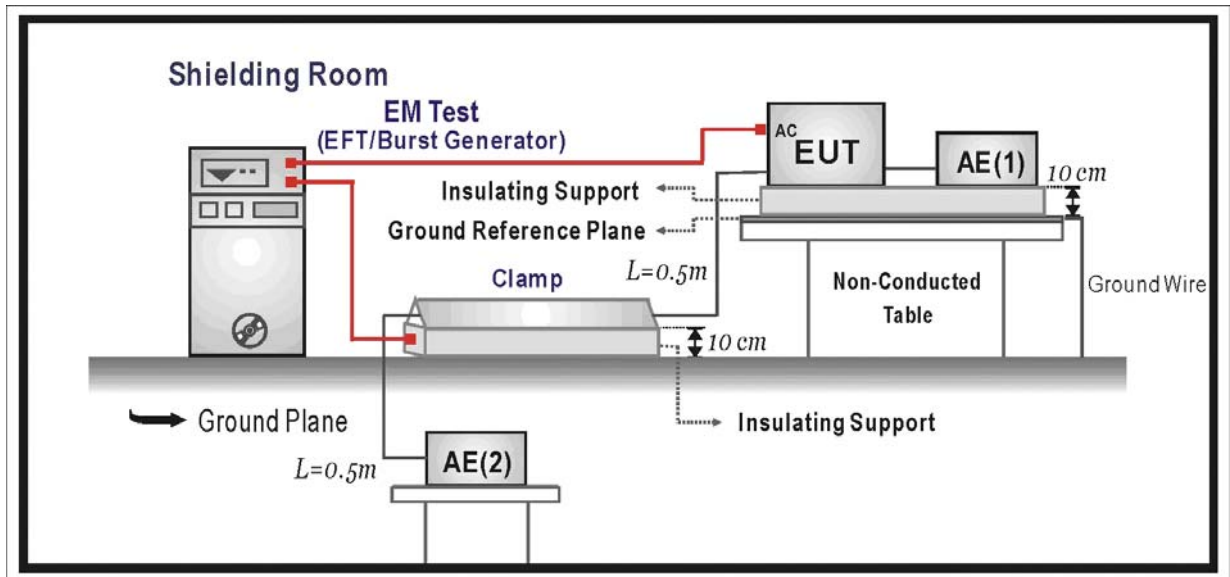

10.3. Limit

Item	Environmental Phenomena	Units	Test Specification	Performance Criteria
I/O and communication ports				
	Fast Transients Common Mode	kV (Peak) Tr/Th ns Rep. Frequency kHz	+0.5 5/50 5	B
Input DC Power Ports				
	Fast Transients Common Mode	kV (Peak) Tr/Th ns Rep. Frequency kHz	+0.5 5/50 5	B
Input AC Power Ports				
	Fast Transients Common Mode	kV (Peak) Tr/Th ns Rep. Frequency kHz	+1 5/50 5	B

10.4. Test Procedure

The EUT is placed on a table that is 0.8 meter height. A ground reference plane is placed on the table, and uses a 0.1m insulation between the EUT and ground reference plane.

The minimum area of the ground reference plane is 1m*1m, and 0.65mm thick min, and projected beyond the EUT by at least 0.1m on all sides.

Test on I/O and communication ports:

The EFT interference signal is through a coupling clamp device couples to the signal and control lines of the EUT with burst noise for 1 minute.

Test on power supply ports:

The EUT is connected to the power mains through a coupling device that directly couples the EFT/B interference signal.

Each of the Line and Neutral conductors is impressed with burst noise for 1 minute.

The length of the signal and power lines between the coupling device and the EUT is 0.5m.

10.5. Deviation from Test Standard

No deviation.

10.6. Test Result

Product	Outdoor Network Camera		
Test Item	Electrical fast transient/burst		
Test Mode	Mode 1: Normal Operation (Adapter)		
Date of Test	2010/03/18	Test Site	No.6 Shielded Room

Inject Line	Polarity	Voltage kV	Inject Time (Second)	Inject Method	Required Criteria	Complied to Criteria	Result
L+N	±	1kV	60	Direct	B	A	PASS
LAN	±	0.5kV	60	Clamp	B	A	PASS

Note:

The testing performed is from lowest level up to the highest level as required by standard, but only highest level is shown on the report.

- Meet criteria A : Operate as intended during and after the test
- Meet criteria B : Operate as intended after the test
- Meet criteria C : Loss/Error of function
- Additional Information
 - EUT stopped operation and could / could not be reset by operator at _____ kV of Line _____.
- No false alarms or other malfunctions were observed during or after the test.

Product	Outdoor Network Camera		
Test Item	Electrical fast transient/burst		
Test Mode	Mode 2: Normal Operation (PoE)		
Date of Test	2010/03/18	Test Site	No.6 Shielded Room

Inject Line	Polarity	Voltage kV	Inject Time (Second)	Inject Method	Required Criteria	Complied to Criteria	Result
LAN	±	0.5kV	60	Clamp	B	A	PASS

Note:

The testing performed is from lowest level up to the highest level as required by standard, but only highest level is shown on the report.

- Meet criteria A : Operate as intended during and after the test
- Meet criteria B : Operate as intended after the test
- Meet criteria C : Loss/Error of function
- Additional Information
 - EUT stopped operation and could / could not be reset by operator at _____ kV of Line _____.
- No false alarms or other malfunctions were observed during or after the test.

10.7. Test Photograph

Test Mode : Mode 1: Normal Operation (Adapter)

Description : EFT/B Test Setup



Test Mode : Mode 1: Normal Operation (Adapter)

Description : EFT/B Test Setup-Clamp



Test Mode : Mode 2: Normal Operation (PoE)

Description : EFT/B Test Setup-Clamp



11. Surge

11.1. Test Specification

According to Standard : IEC 61000-4-5

11.2. Test Setup

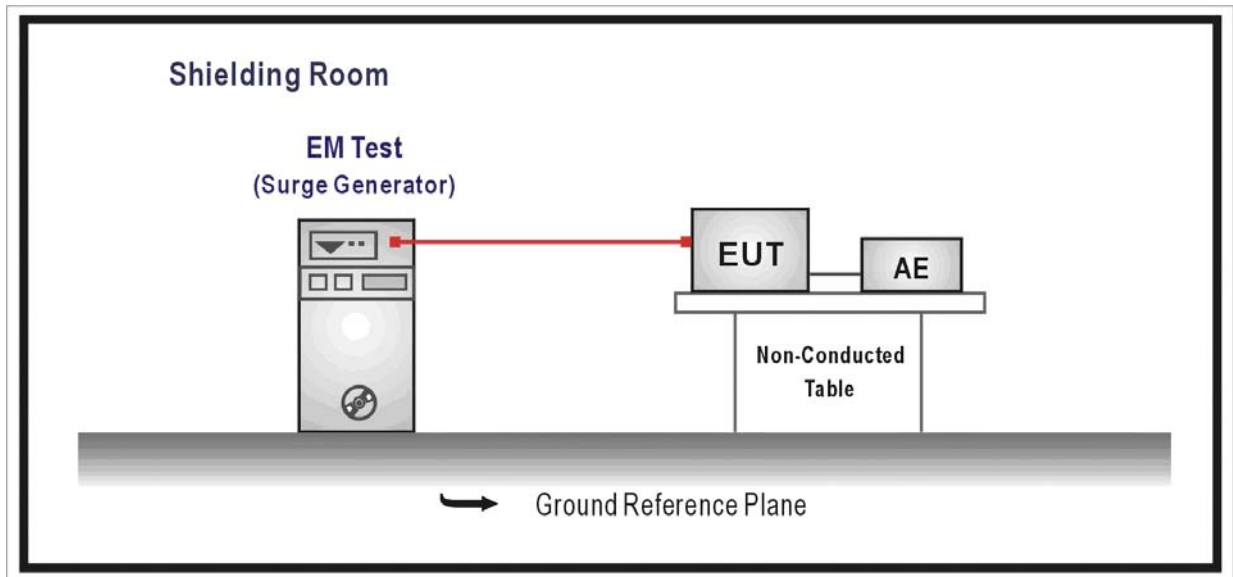

11.3. Limit

Item	Environmental Phenomena	Units	Test Specification	Performance Criteria
Signal Ports and Telecommunication Ports(See 1) and 2))				
	Surges Line to Ground	Tr/Th us kV	1.2/50 (8/20) ± 1	B
Input DC Power Ports				
	Surges Line to Ground	Tr/Th us kV	1.2/50 (8/20) ± 0.5	B
AC Input and AC Output Power Ports				
	Surges Line to Line Line to Ground	Tr/Th us kV kV	1.2/50 (8/20) ± 1 ± 2	B

Notes:

- 1) Applicable only to ports which according to the manufacturer’s may directly to outdoor cables.
- 2) Where normal functioning cannot be achieved because of the impact of the CDN on the EUT, no immunity test shall be required.

11.4. Test Procedure

The EUT and its load are placed on a table that is 0.8 meter above a metal ground plane measured 1m*1m min. and 0.65mm thick min. And projected beyond the EUT by at least 0.1m on all sides. The length of power cord between the coupling device and the EUT shall be 2m or less.

For Input and Output AC Power or DC Input and DC Output Power Ports:

The EUT is connected to the power mains through a coupling device that directly couples the Surge interference signal.

The surge noise shall be applied synchronized to the voltage phase at 0⁰, 90⁰, 180⁰, 270⁰ and the peak value of the a.c. voltage wave. (Positive and negative)

Each of Line-Earth and Line-Line is impressed with a sequence of five surge voltages with interval of 1 min.

11.5. Deviation from Test Standard

No deviation.

11.6. Test Result

Product	Outdoor Network Camera		
Test Item	Surge		
Test Mode	Mode 1: Normal Operation (Adapter)		
Date of Test	2010/03/18	Test Site	No.6 Shielded Room

Inject Line	Polarity	Angle	Voltage kV	Time Interval (Second)	Inject Method	Required Criteria	Complied to Criteria	Result
L-N	±	0	1kV	60	Direct	B	A	PASS
L-N	±	90	1kV	60	Direct	B	A	PASS
L-N	±	180	1kV	60	Direct	B	A	PASS
L-N	±	270	1kV	60	Direct	B	A	PASS
L-PE	±	0	2kV	60	Direct	B	A	PASS
L-PE	±	90	2kV	60	Direct	B	A	PASS
L-PE	±	180	2kV	60	Direct	B	A	PASS
L-PE	±	270	2kV	60	Direct	B	A	PASS
N-PE	±	0	2kV	60	Direct	B	A	PASS
N-PE	±	90	2kV	60	Direct	B	A	PASS
N-PE	±	180	2kV	60	Direct	B	A	PASS
N-PE	±	270	2kV	60	Direct	B	A	PASS

Note:

The testing performed is from lowest level up to the highest level as required by standard, but only highest level is shown on the report.

- Meet criteria A : Operate as intended during and after the test
- Meet criteria B : Operate as intended after the test
- Meet criteria C : Loss/Error of function
- Additional Information
 - EUT stopped operation and could / could not be reset by operator at _____ kV of Line _____.
- No false alarms or other malfunctions were observed during or after the test.

11.7. Test Photograph

Test Mode : Mode 1: Normal Operation (Adapter)

Description : SURGE Test Setup



12. Conducted Susceptibility

12.1. Test Specification

According to Standard : IEC 61000-4-6

12.2. Test Setup

CDN Test Mode

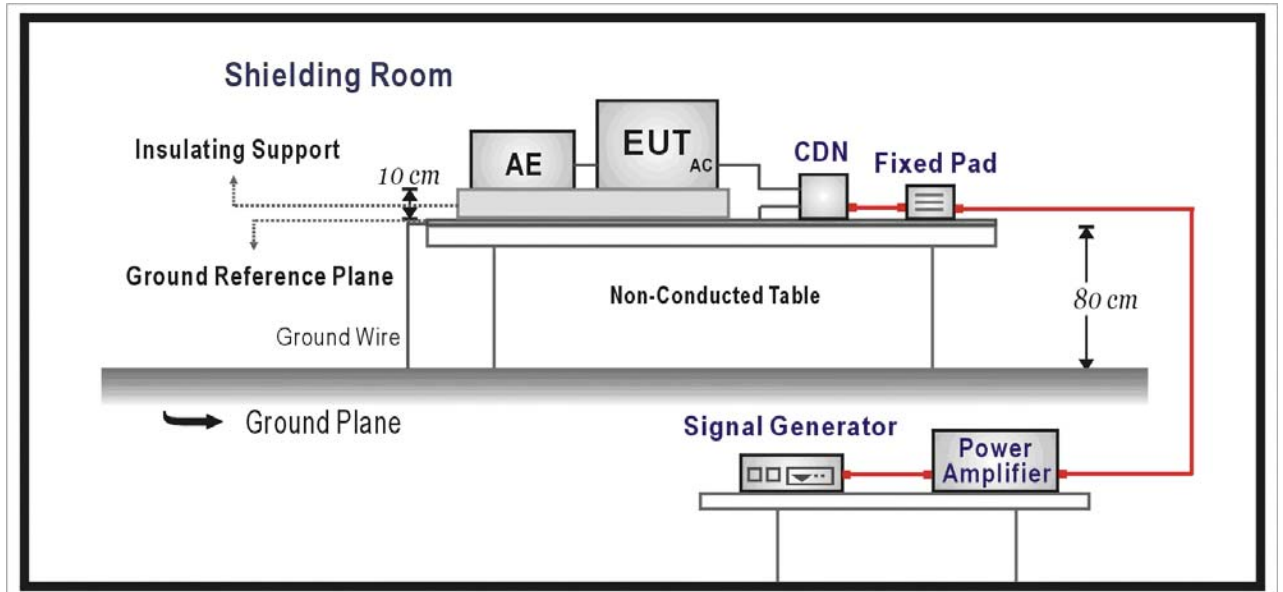

EM Clamp Test Mode

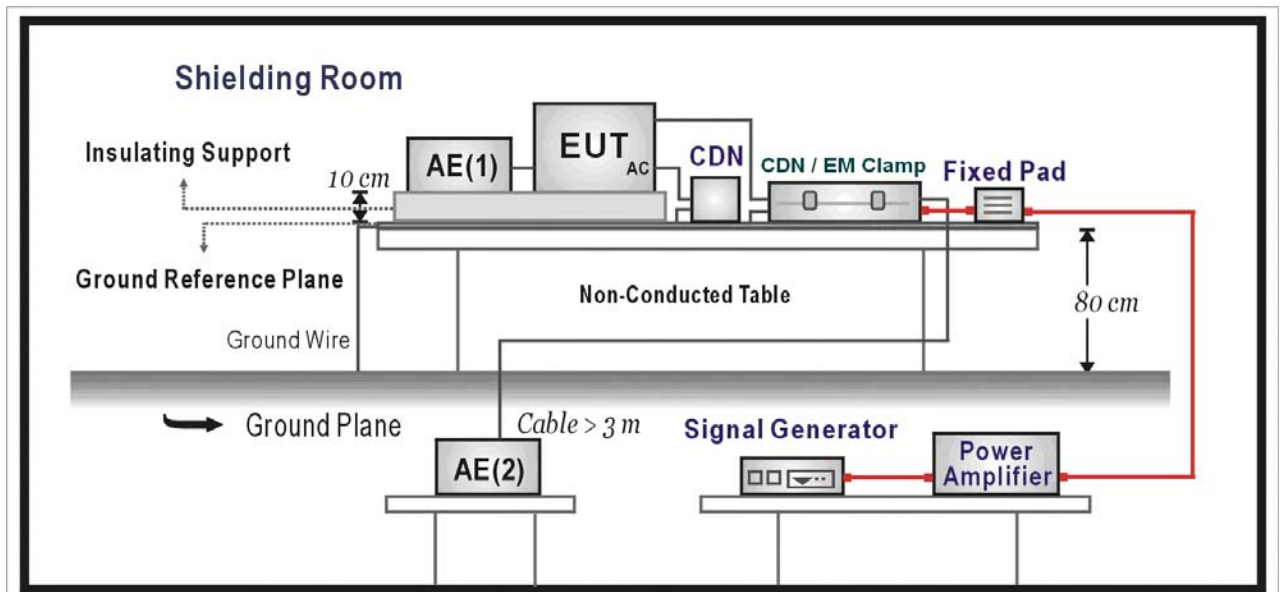

12.3. Limit

Item	Environmental Phenomena	Units	Test Specification	Performance Criteria
Signal Ports and Telecommunication Ports				
	Radio-Frequency Continuous Conducted	MHz V (rms, Un-modulated) % AM (1kHz)	0.15-80 3 80	A
Input DC Power Ports				
	Radio-Frequency Continuous Conducted	MHz V (rms, Un-modulated) % AM (1kHz)	0.15-80 3 80	A
Input AC Power Ports				
	Radio-Frequency Continuous Conducted	MHz V (rms, Un-modulated) % AM (1kHz)	0.15-80 3 80	A

12.4. Test Procedure

The EUT are placed on a table that is 0.8 meter height, and a Ground reference plane on the table, EUT are placed upon table and use a 10cm insulation between the EUT and Ground reference plane.

For Signal Ports and Telecommunication Ports

The disturbance signal is through a coupling and decoupling networks (CDN) or EM-clamp device couples to the signal and Telecommunication lines of the EUT.

For Input DC and AC Power Ports

The EUT is connected to the power mains through a coupling and decoupling networks for power supply lines. And directly couples the disturbances signal into EUT.

Used CDN-M2 for two wires or CDN-M3 for three wires.

All the scanning conditions are as follows:

Condition of Test	Remarks
1. Field Strength	130dBuV(3V) Level 2
2. Radiated Signal	AM 80% Modulated with 1kHz
3. Scanning Frequency	0.15MHz – 80MHz
4. Dwell Time	3 Seconds
5. Frequency step size Δf :	1%
6. The rate of Swept of Frequency	1.5×10^{-3} decades/s

12.5. Deviation from Test Standard

No deviation.

12.6. Test Result

Product	Outdoor Network Camera		
Test Item	Conducted susceptibility		
Test Mode	Mode 1: Normal Operation (Adapter)		
Date of Test	2010/03/18	Test Site	No.6 Shielded Room

Frequency Range (MHz)	Voltage Applied dBuV(V)	Inject Method	Tested Port of EUT	Required Criteria	Performance Criteria Complied To	Result
0.15~80	130 (3V)	CDN	AC IN	A	A	PASS
0.15~80	130 (3V)	CDN	LAN	A	A	PASS

Note:

The testing performed is from lowest level up to the highest level as required by standard, but only highest level is shown on the report.

- Meet criteria A : Operate as intended during and after the test
- Meet criteria B : Operate as intended after the test
- Meet criteria C : Loss/Error of function
- Additional Information
 - EUT stopped operation and could / could not be reset by operator at _____ dBuV(V) at frequency _____MHz.
 - No false alarms or other malfunctions were observed during or after the test. The acceptance criteria were met, and the EUT passed the test.

Product	Outdoor Network Camera		
Test Item	Conducted susceptibility		
Test Mode	Mode 2: Normal Operation (PoE)		
Date of Test	2010/03/18	Test Site	No.6 Shielded Room

Frequency Range (MHz)	Voltage Applied dBuV(V)	Inject Method	Tested Port of EUT	Required Criteria	Performance Criteria Complied To	Result
0.15~80	130 (3V)	Clamp	LAN	A	A	PASS

Note:

The testing performed is from lowest level up to the highest level as required by standard, but only highest level is shown on the report.

- Meet criteria A : Operate as intended during and after the test
- Meet criteria B : Operate as intended after the test
- Meet criteria C : Loss/Error of function
- Additional Information
 - EUT stopped operation and could / could not be reset by operator at _____ dBuV(V) at frequency _____MHz.
 - No false alarms or other malfunctions were observed during or after the test. The acceptance criteria were met, and the EUT passed the test.

12.7. Test Photograph

Test Mode : Mode 1: Normal Operation (Adapter)

Description : Conducted Susceptibility Test Setup



Test Mode : Mode 1: Normal Operation (Adapter)

Description : Conducted Susceptibility Test Setup-CDN



Test Mode : Mode 2: Normal Operation (PoE)

Description : Conducted Susceptibility Test Setup-Clamp



13. Power Frequency Magnetic Field

13.1. Test Specification

According to Standard : IEC 61000-4-8

13.2. Test Setup

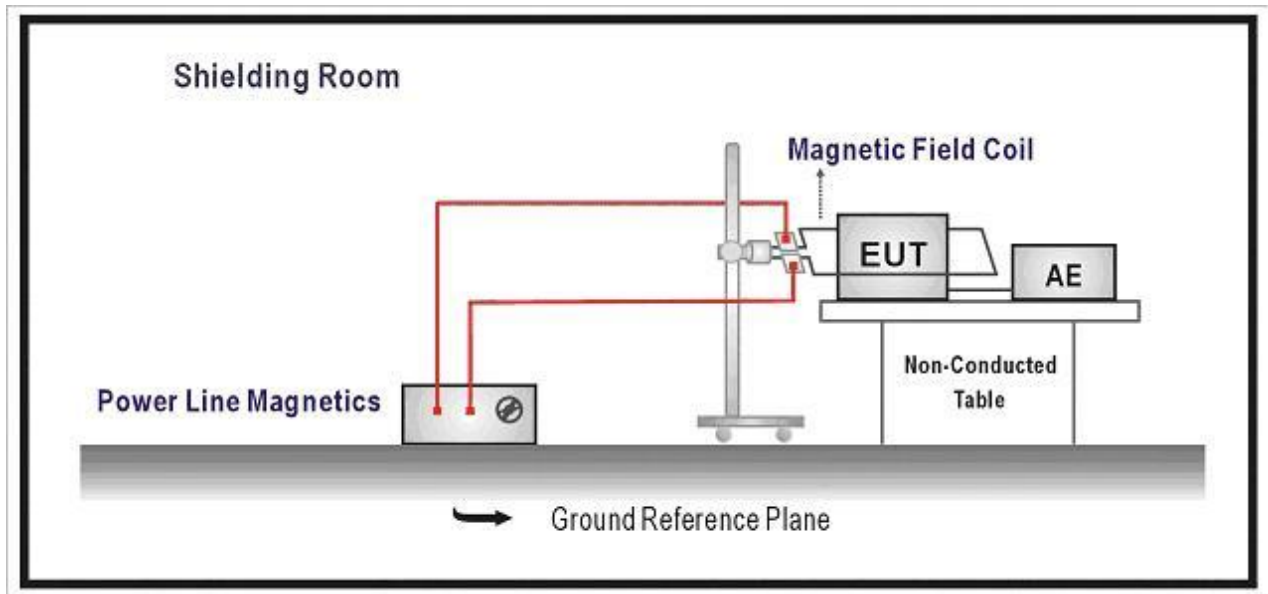

13.3. Limit

Item	Environmental Phenomena	Units	Test Specification	Performance Criteria
Enclosure Port				
	Power-Frequency Magnetic Field	Hz A/m (r.m.s.)	50 1	A

13.4. Test Procedure

The EUT and its load are placed on a table which is 0.8 meter above a metal ground plane measured at least 1m*1m min. The test magnetic field shall be placed at central of the induction coil.

The test magnetic Field shall be applied 10 minutes by the immersion method to the EUT. And the induction coil shall be rotated by 90° in order to expose the EUT to the test field with different orientation (X, Y, Z Orientations).

13.5. Deviation from Test Standard

No deviation.

13.6. Test Result

Product	Outdoor Network Camera		
Test Item	Power frequency magnetic field		
Test Mode	Mode 1: Normal Operation (Adapter)		
Date of Test	2010/03/18	Test Site	No.3 Shielded Room

Polarization	Frequency (Hz)	Magnetic Strength (A/m)	Required Performance Criteria	Performance Criteria Complied To	Test Result
X Orientation	50	1	A	A	PASS
Y Orientation	50	1	A	A	PASS
Z Orientation	50	1	A	A	PASS

- Meet criteria A: Operate as intended during and after the test
- Meet criteria B: Operate as intended after the test
- Meet criteria C: Loss/Error of function
- Additional Information
 - EUT stopped operation and could / could not be reset by operator at _____ kV of Line _____.
- No false alarms or other malfunctions were observed during or after the test. The acceptance criteria were met, and the EUT passed the test.

13.7. Test Photograph

Test Mode : Mode 1: Normal Operation (Adapter)

Description : Power Frequency Magnetic Field Test Setup



14. Voltage Dips and Interruption

14.1. Test Specification

According to Standard : IEC 61000-4-11

14.2. Test Setup

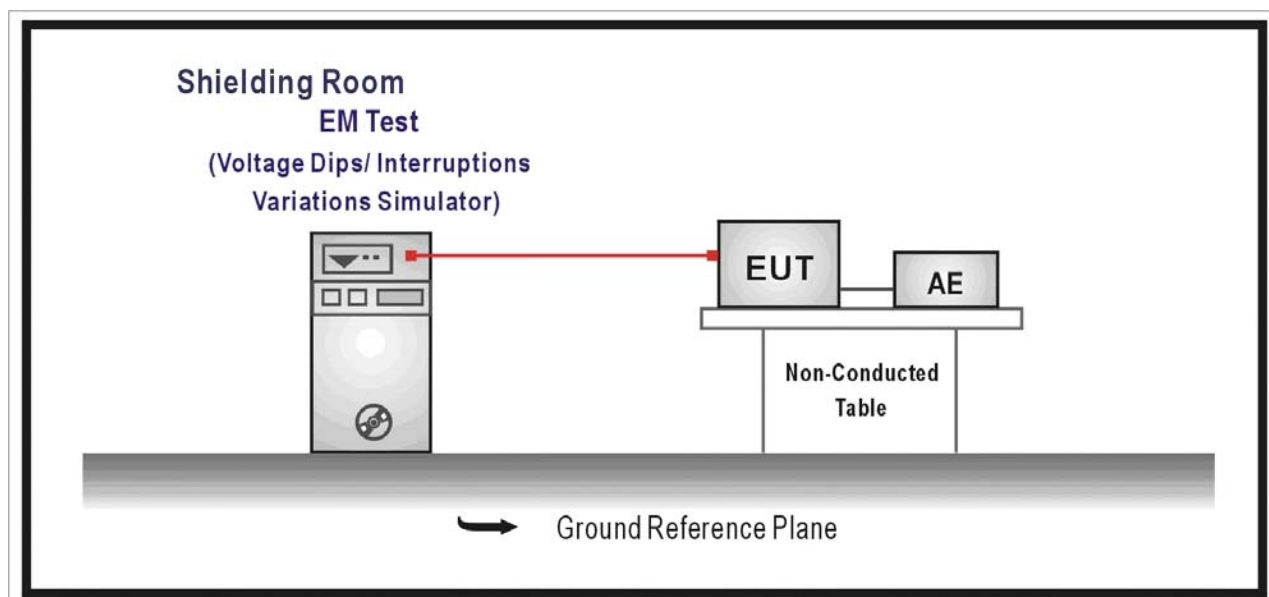

14.3. Limit

Item	Environmental Phenomena	Units	Test Specification	Performance Criteria
Input AC Power Ports				
	Voltage Dips	% Reduction	30	C
		Period	25	
	Voltage Dips	% Reduction	>95	B
		Period	0.5	
	Voltage Interruptions	% Reduction	> 95	C
		Period	250	

14.4. Test Procedure

The EUT and its load are placed on a table which is 0.8 meter above a metal ground plane measured 1m*1m min. And 0.65mm thick min. And projected beyond the EUT by at least 0.1m on all sides. The power cord shall be used the shortest power cord as specified by the manufacturer.

For Voltage Dips/ Interruptions test:

The selection of test voltage is based on the rated power range. If the operation range is large than 20% of lower power range, both end of specified voltage shall be tested.

Otherwise, the typical voltage specification is selected as test voltage.

The EUT is connected to the power mains through a coupling device that directly couples to the Voltage Dips and Interruption Generator.

The EUT shall be tested for 30% voltage dip of supplied voltage and duration 25 Periods, for 95% voltage dip of supplied voltage and duration 0.5 Periods with a sequence of three voltage dips with intervals of 10 seconds, and for 95% voltage interruption of supplied voltage and duration 250 Periods with a sequence of three voltage interruptions with intervals of 10 seconds.

Voltage phase shifting are shall occur at 0° , 45° , 90° , 135° , 180° , 225° , 270° , 315° of the voltage.

14.5. Deviation from Test Standard

No deviation.

14.6. Test Result

Product	Outdoor Network Camera		
Test Item	Voltage dips and interruption		
Test Mode	Mode 1: Normal Operation (Adapter)		
Date of Test	2010/03/18	Test Site	No.6 Shielded Room

Voltage Dips and Interruption Reduction(%)	Angle	Test Duration (Periods)	Required Performance Criteria	Performance Criteria Complied To	Test Result
30	0	25	C	A	PASS
30	45	25	C	A	PASS
30	90	25	C	A	PASS
30	135	25	C	A	PASS
30	180	25	C	A	PASS
30	225	25	C	A	PASS
30	270	25	C	A	PASS
30	315	25	C	A	PASS
>95	0	0.5	B	A	PASS
>95	45	0.5	B	A	PASS
>95	90	0.5	B	A	PASS
>95	135	0.5	B	A	PASS
>95	180	0.5	B	A	PASS
>95	225	0.5	B	A	PASS
>95	270	0.5	B	A	PASS
>95	315	0.5	B	A	PASS
>95	0	250	C	B	PASS
>95	45	250	C	B	PASS
>95	90	250	C	B	PASS
>95	135	250	C	B	PASS
>95	180	250	C	B	PASS
>95	225	250	C	B	PASS
>95	270	250	C	B	PASS
>95	315	250	C	B	PASS

- Meet criteria A: Operate as intended during and after the test
- Meet criteria B: Operate as intended after the test
- Meet criteria C: Loss/Error of function
- Additional Information
 - The nominal voltage of EUT is 230V.
 - EUT stopped operation and could / could not be reset by operator at _____ kV of Line _____.
- No false alarms or other malfunctions were observed during or after the test. The acceptance criteria were met, and the EUT passed the test.

14.7. Test Photograph

Test Mode : Mode 1: Normal Operation (Adapter)

Description : Voltage Dips Test Setup



15. Attachment

➤ EUT Photograph

(1) EUT Photo



(2) EUT Photo



(3) EUT Photo



(4) EUT Photo



(5) EUT Photo



(6) EUT Photo

