



CERTIFICATE

Issued Date: June 01, 2010
Report No.: 105284R-ITCEP11V03

This is to certify that the following designated product

Product : Vandal Dome Network Camera
Trade name : VIVOTEK
Model Number : FD8361
Company Name : VIVOTEK INC.

This product, which has been issued the test report listed as above in QuietTek Laboratory, is based on a single evaluation of one sample and confirmed to comply with the requirements of the following EMC standard.

EN 55022: 2006+A1: 2007

EN 61000-3-2:2006

EN 61000-3-3:2008

AS/NZS CISPR 22: 2006

EN 55024: 1998+A1: 2001+A2: 2003

IEC 61000-4-2: 2008

IEC 61000-4-3: 2008

IEC 61000-4-4: 2004

IEC 61000-4-5: 2005

IEC 61000-4-6: 2008

IEC 61000-4-8: 2009

IEC 61000-4-11: 2004

TEST LABORATORY

Vincent Lin / Manager



Test Report

Product Name : Vandal Dome Network Camera

Model No. : FD8361

Applicant : VIVOTEK INC.

Address : 6F, No.192, Lien-Cheng Rd., Chung-Ho City, Taipei
County, Taiwan, R.O.C.

Date of Receipt : 2010/05/17

Issued Date : 2010/06/01

Report No. : 105284R-ITCEP11V03

Report Version : V1.0

The test results relate only to the samples tested.

The test results shown in the test report are traceable to the national/international standard through the calibration of the equipment and evaluated measurement uncertainty herein.

This report must not be used to claim product endorsement by TAF, NVLAP or any agency of the Government.

The test report shall not be reproduced except in full without the written approval of QuieTek Corporation.



Declaration of Conformity

We herewith confirm the following designated products to comply with the requirements set out in the Council Directive on the approximation of the laws of the Member States relating to Electromagnetic Compatibility Directive (2004/108/EC) with applicable standards listed below.

Product : Vandal Dome Network Camera
Trade name : VIVOTEK
Model Number : FD8361
Applicable Harmonized : EN 55022:2006+A1: 2007, Class A
Standards under Directive EN 55024: 1998+A1: 2001+A2: 2003
2004/108/EC EN 61000-3-2:2006, Class A
EN 61000-3-3:2008

Company Name : _____
Company Address : _____
Telephone : _____ Facsimile : _____

Person in responsible for marking this declaration:

_____ Name (Full Name)	_____ Title/ Department
_____ Date	_____ Legal Signature



Statement of Conformity

This statement is to certify that the designated product below.

Product : Vandal Dome Network Camera
Trade name : VIVOTEK
Model Number : FD8361
Company Name : VIVOTEK INC.
Applicable Standards : EN 55022:2006+A1: 2007, Class A
EN 55024: 1998+A1: 2001+A2: 2003
EN 61000-3-2:2006, Class A
EN 61000-3-3:2008

One sample of the designated product has been tested and evaluated in our laboratory to find in compliance with the applicable standards above. The issued test report(s) show(s) it in detail.

Report Number : 105284R-ITCEP11V03



TEST LABORATORY

Vincent Lin / Manager

The verification is based on a single evaluation of one sample of above-mentioned products. It does not imply an assessment of the whole production and does not permit the use of the test lab. Logo.

Test Report Certification

Issued Date : 2010/06/01

Report No. : 105284R-ITCEP11V03



Product Name : Vandal Dome Network Camera
Applicant : VIVOTEK INC.
Address : 6F, No.192, Lien-Cheng Rd., Chung-Ho City, Taipei County,
Taiwan, R.O.C.
Manufacturer : VIVOTEK INC.
Model No. : FD8361
EUT Rated Voltage : AC 100-240V, 50-60Hz
EUT Test Voltage : 1. AC 100-240V/50-60Hz(Adapter)
2. By PoE
3. AC 24V
Trade Name : VIVOTEK
Applicable Standard : EN 55022: 2006+A1: 2007, Class A
EN 55024: 1998+A1: 2001+A2: 2003
EN 61000-3-2:2006
EN 61000-3-3:2008
AS/NZS CISPR 22: 2006
Test Result : Complied
Performed Location : Quietek Corporation (Linkou Laboratory)
No.5-22, Ruei-Shu Valley, Ruei-Ping Tsuen Lin Kuo Shiang,
Taipei, 244 Taiwan, R.O.C.
TEL:+866-2-8601-3788 / FAX:+886-2-8601-3789

Documented By :

(Adm. Specialist / Joanne Lin)

Reviewed By :

(Assistant Engineer / Tim Ho)

Approved By :

(Manager / Vincent Lin)

Laboratory Information

We, **Quietek Corporation**, are an independent EMC and safety consultancy that was established the whole facility in our laboratories. The test facility has been accredited/accepted (audited or listed) by the following related bodies in compliance with ISO 17025, EN 45001 and specified testing scopes:

Taiwan R.O.C.	:	BSMI, NCC, TAF
Germany	:	TUV Rheinland
Norway	:	Nemko, DNV
USA	:	FCC, NVLAP
Japan	:	VCCI

The related certificate for our laboratories about the test site and management system can be downloaded from Quietek Corporation's Web Site : <http://www.quietek.com/tw/ctg/cts/accreditations.htm>
 The address and introduction of Quietek Corporation's laboratories can be founded in our Web site : <http://www.quietek.com/>

If you have any comments, Please don't hesitate to contact us. Our contact information is as below:

HsinChu Testing Laboratory :

No.75-2, 3rd Lin, Wangye Keng, Yonghxing Tsuen, Qionglin Shiang, Hsinchu County 307, Taiwan, R.O.C.

TEL:+886-3-592-8858 / FAX:+886-3-592-8859

E-Mail : service@quietek.com



LinKou Testing Laboratory :

No. 5-22, Ruei-Shu Valley, Ruei-Ping Tsuen, Lin-Kou Shiang, Taipei, Taiwan, R.O.C.

TEL : 886-2-8601-3788 / FAX : 886-2-8601-3789

E-Mail : service@quietek.com



Suzhou (China) Testing Laboratory :

No. 99 Hongye Rd., Suzhou Industrial Park Loufeng Hi-Tech Development Zone., Suzhou, China.

TEL : +86-512-6251-5088 / FAX : +86-512-6251-5098

E-Mail : service@quietek.com



TABLE OF CONTENTS

Description	Page
1. General Information	7
1.1. EUT Description.....	7
1.2. Mode of Operation	8
1.3. Tested System Details	9
1.4. Configuration of Tested System	10
1.5. EUT Exercise Software.....	11
2. Technical Test	12
2.1. Summary of Test Result.....	12
2.2. List of Test Equipment	13
2.3. Measurement Uncertainty.....	16
2.4. Test Environment.....	18
3. Conducted Emission (Main Terminals).....	19
3.1. Test Specification	19
3.2. Test Setup.....	19
3.3. Limit.....	19
3.4. Test Procedure	20
3.5. Deviation from Test Standard.....	20
3.6. Test Result.....	21
3.7. Test Photograph	33
4. Conducted Emissions (Telecommunication Ports).....	34
4.1. Test Specification	35
4.2. Test Setup.....	35
4.3. Limit.....	35
4.4. Test Procedure	36
4.5. Deviation from Test Standard.....	36
4.6. Test Result.....	37
4.7. Test Photograph	55
5. Radiated Emission.....	58
5.1. Test Specification	58
5.2. Test Setup.....	58
5.3. Limit.....	59
5.4. Test Procedure	60
5.5. Deviation from Test Standard.....	60
5.6. Test Result.....	61
5.7. Test Photograph	73
6. Harmonic Current Emission	78

6.1.	Test Specification	78
6.2.	Test Setup.....	78
6.3.	Limit.....	78
6.4.	Test Procedure	80
6.5.	Deviation from Test Standard.....	80
6.6.	Test Result.....	81
6.7.	Test Photograph	85
7.	Voltage Fluctuation and Flicker.....	86
7.1.	Test Specification.....	86
7.2.	Test Setup.....	86
7.3.	Limit.....	86
7.4.	Test Procedure	87
7.5.	Deviation from Test Standard.....	87
7.6.	Test Result.....	88
7.7.	Test Photograph	90
8.	Electrostatic Discharge	91
8.1.	Test Specification.....	91
8.2.	Test Setup.....	91
8.3.	Limit.....	91
8.4.	Test Procedure	92
8.5.	Deviation from Test Standard.....	92
8.6.	Test Result.....	93
8.7.	Test Photograph	96
9.	Radiated Susceptibility	98
9.1.	Test Specification.....	98
9.2.	Test Setup.....	98
9.3.	Limit.....	98
9.4.	Test Procedure	99
9.5.	Deviation from Test Standard.....	99
9.6.	Test Result.....	100
9.7.	Test Photograph	103
10.	Electrical Fast Transient/Burst	105
10.1.	Test Specification.....	105
10.2.	Test Setup.....	105
10.3.	Limit.....	105
10.4.	Test Procedure	106
10.5.	Deviation from Test Standard.....	106
10.6.	Test Result.....	107

10.7.	Test Photograph	110
11.	Surge	113
11.1.	Test Specification	113
11.2.	Test Setup.....	113
11.3.	Limit.....	113
11.4.	Test Procedure	114
11.5.	Deviation from Test Standard.....	114
11.6.	Test Result.....	115
11.7.	Test Photograph	117
12.	Conducted Susceptibility.....	118
12.1.	Test Specification	118
12.2.	Test Setup.....	118
12.3.	Limit.....	119
12.4.	Test Procedure	119
12.5.	Deviation from Test Standard.....	119
12.6.	Test Result.....	120
12.7.	Test Photograph	123
13.	Power Frequency Magnetic Field	126
13.1.	Test Specification	126
13.2.	Test Setup.....	126
13.3.	Limit.....	126
13.4.	Test Procedure	126
13.5.	Deviation from Test Standard.....	126
13.6.	Test Result.....	127
13.7.	Test Photograph	130
14.	Voltage Dips and Interruption.....	132
14.1.	Test Specification	132
14.2.	Test Setup.....	132
14.3.	Limit.....	132
14.4.	Test Procedure	133
14.5.	Deviation from Test Standard.....	133
14.6.	Test Result.....	134
14.7.	Test Photograph	136
15.	Attachment.....	137
	EUT Photograph.....	137

1. General Information**1.1. EUT Description**

Product Name	Vandal Dome Network Camera
Trade Name	VIVOTEK
Model No.	FD8361

Component	
Power Adapter	MFR: ENG, M/N: 3A-183WP12 Input: AC 100-240, 50-60Hz, 0.6A Output: DC 12V, 1.5A Cable Out: Non-shielded, 1.6m

1.2. Mode of Operation

Quietek has verified the construction and function in typical operation. All the test modes were carried out with the EUT in normal operation, which was shown in this test report and defined as:

Pre-Test Mode	
Mode 1: Normal Operation (Adapter: 3A-183WP12)	
Mode 2: Normal Operation (AC 24V)	
Mode 3: PoE Mode	
Final Test Mode	
Emission	Mode 1: Normal Operation (Adapter: 3A-183WP12) Mode 2: Normal Operation (AC 24V) Mode 3: PoE Mode
Immunity	Mode 1: Normal Operation (Adapter: 3A-183WP12) Mode 2: Normal Operation (AC 24V) Mode 3: PoE Mode

1.3. Tested System Details

The types for all equipments, plus descriptions of all cables used in the tested system (including inserted cards) are:

Product	Manufacturer	Model No.	Serial No.	Power Cord	
1	Monitor	SONY	PVM-14M2U	2111389	Non-Shielded, 1.8m
2	Microphone & Earphone (EMI)	PCHOME	N/A	N/A	N/A
	Microphone & Earphone (EMS)	Ergotech	ET-E201	N/A	N/A
3	Notebook PC	DELL	D630	00144-023-351-375	Non-Shielded, 0.8m

1.4. Configuration of Tested System

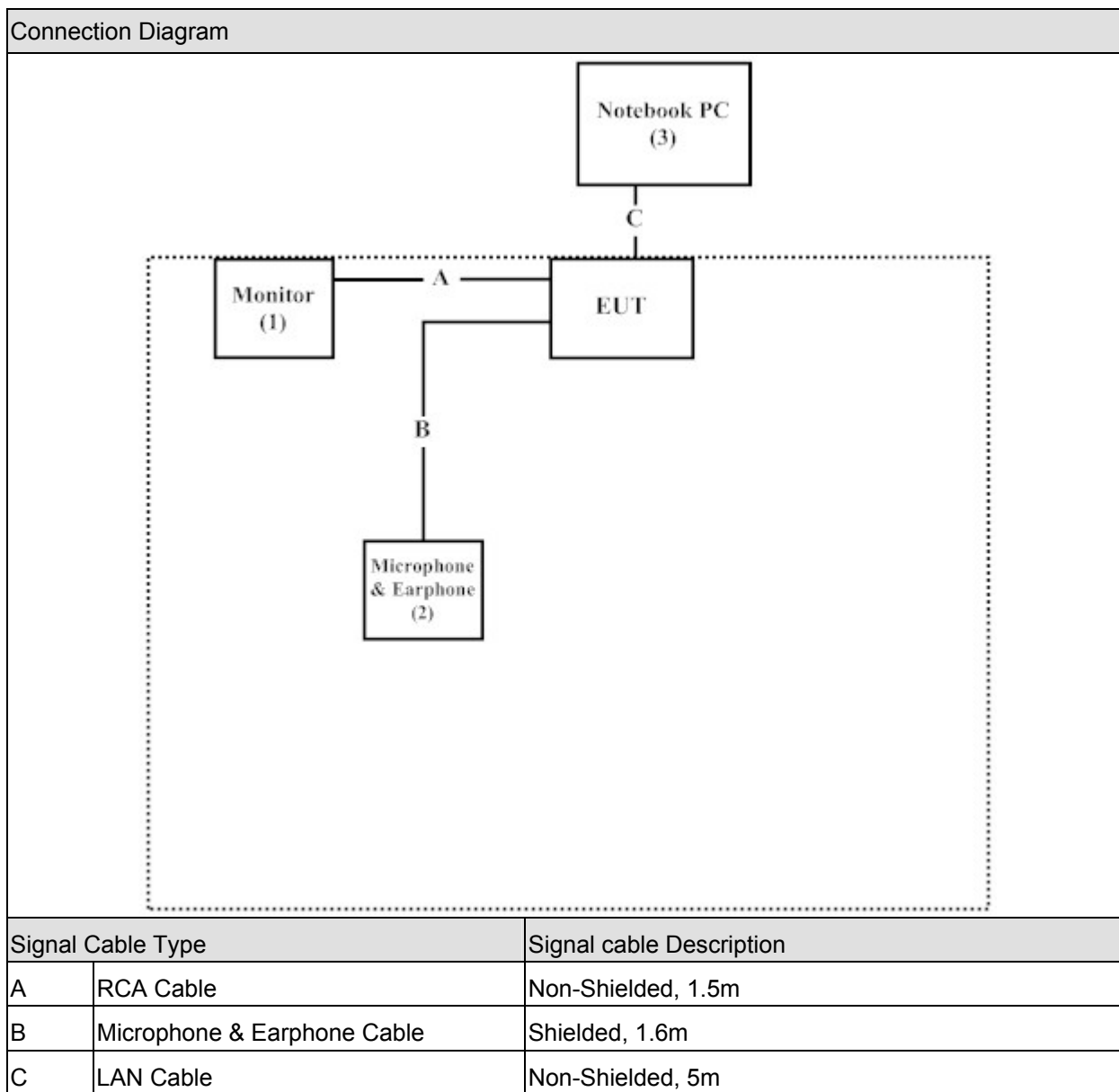

1.5. EUT Exercise Software

1	Setup the EUT and simulators as shown on 1.4.
2	Turn on the power of all equipment.
3	The EUT will start to operate and display the video figure from the signal source.
4	The EUT will display “video figure” on monitor.
5	Repeat the above procedure (3) to (4).

2. Technical Test

2.1. Summary of Test Result

- No deviations from the test standards
 Deviations from the test standards as below description:

Emission			
Performed Item	Normative References	Test Performed	Deviation
Conducted Emission	EN 55022: 2006+A1: 2007 AS/NZS CISPR 22: 2006	Yes	No
Impedance Stabilization Network	EN 55022: 2006+A1: 2007 AS/NZS CISPR 22: 2006	Yes	No
Radiated Emission	EN 55022: 2006+A1: 2007 AS/NZS CISPR 22: 2006	Yes	No
Power Harmonics	EN 61000-3-2:2006	Yes	No
Voltage Fluctuation and Flicker	EN 61000-3-3:2008	Yes	No

Immunity			
Performed Item	Normative References	Test Performed	Deviation
Electrostatic Discharge	IEC 61000-4-2: 2008	Yes	No
Radiated susceptibility	IEC 61000-4-3: 2008	Yes	No
Electrical fast transient/burst	IEC 61000-4-4: 2004	Yes	No
Surge	IEC 61000-4-5: 2005	Yes	No
Conducted susceptibility	IEC 61000-4-6: 2008	Yes	No
Power frequency magnetic field	IEC 61000-4-8: 2009	Yes	No
Voltage dips and interruption	IEC 61000-4-11: 2004	Yes	No

2.2. List of Test Equipment

Conducted Emission / SR1

Instrument	Manufacturer	Type No.	Serial No	Cal. Date
EMI Test Receiver	R&S	ESCS 30	100366	2009/10/29
LISN	R&S	ENV4200	833209/007	2009/08/14
LISN	R&S	ENV216	100085	2010/02/17
Pulse Limiter	R&S	ESH3-Z2	357.88.10.52	2009/09/10

Impedance Stabilization Network / SR1

Instrument	Manufacturer	Type No.	Serial No	Cal. Date
Capacitive Voltage Probe	Schaffner	CVP2200A	18331	2009/11/16
EMI Test Receiver	R&S	ESCS 30	100366	2009/10/29
LISN	R&S	ENV216	100085	2010/02/17
LISN	R&S	ENV4200	833209/007	2009/08/14
Pulse Limiter	R&S	ESH3-Z2	357.88.10.52	2009/09/10
RF Current Probe	FCC	F-65 10KHz~1GHz	198	2009/11/13
BALANCED TELECOM ISN	FCC	FCC-TLISN-T2-02	20316	2009/11/22
BALANCED TELECOM ISN	FCC	FCC-TLISN-T4-02	20317	2009/11/22
BALANCED TELECOM ISN	FCC	FCC-TLISN-T8-02	20319	2009/11/22

Radiated Emission / Site5

Instrument	Manufacturer	Type No.	Serial No	Cal. Date
Bilog Antenna	Schaffner Chase	CBL6112B	2920	2009/08/01
Broadband Horn Antenna	Schwarzbeck	BBHA9170	209	2009/07/25
EMI Test Receiver	R&S	ESCS 30	825442/018	2009/10/12
Horn Antenna	Schwarzbeck	BBHA9120D	305	2009/08/26
Pre-Amplifier	QTK	N/A	N/A	2009/08/01
Spectrum Analyzer	Advantest	R3162	100803463	2009/12/16

Radiated Emission / 9x6x6 Chamber

Instrument	Manufacturer	Type No.	Serial No	Cal. Date
Spectrum Analyzer (9K-26.5GHz)	Agilent	E4408B	MY45102743	2009/08/12
Horn Antenna	Schwarzbeck	9120D	576	2009/10/21
Pre-Amplifier	Quietek	AP-180C	CHM/071920	2009/08/04

Power Harmonics / SR3

Instrument	Manufacturer	Type No.	Serial No	Cal. Date
AC Power Source(Harmonic)	Schaffner	NSG 1007	HK54148	2009/08/11
IEC1000-4-X Analyzer(Flicker)	Schaffner	CCN 1000-1	X7 1887	2009/08/11

Voltage Fluctuation and Flicker / SR3

Instrument	Manufacturer	Type No.	Serial No	Cal. Date
AC Power Source(Harmonic)	Schaffner	NSG 1007	HK54148	2009/08/11
IEC1000-4-X Analyzer(Flicker)	Schaffner	CCN 1000-1	X7 1887	2009/08/11

Electrostatic Discharge / SR3

Instrument	Manufacturer	Type No.	Serial No	Cal. Date
ESD Simulator System	Noiseken	TC-815R	ESS0929097	2009/07/06
Horizontal Coupling Plane(HCP)	Quietek	HCP AL50	N/A	N/A
Vertical Coupling Plane(VCP)	Quietek	VCP AL50	N/A	N/A

Radiated susceptibility / CB5

Instrument	Manufacturer	Type No.	Serial No	Cal. Date
AF-BOX	R&S	AF-BOX ACCUST	100007	N/A
Audio Analyzer	R&S	UPL 16	100137	2010/04/15
Biconilog Antenna	EMCO	3149	00071675	N/A
Directional Coupler	A&R	DC 6180	22735	N/A
Dual Microphone Supply	B&K	5935	2426784	2010/04/16
Mouth Simulator	B&K	4227	2439692	2010/04/16
Power Amplifier	A&R	30S1G3	309453	N/A
Power Amplifier	A&R	100W10000M7	A285000010	N/A
Power Amplifier	SCHAFFNER	CBA9413B	4020	N/A
Power Amplifier	AR	75A250A	0325371	N/A
Power Meter	R&S	NRVD(P.M)	100219	2010/04/16
Pre-Amplifier	A&R	150A220	23067	N/A
Probe Microphone	B&K	4182	2278070	2010/04/16
Signal Generator	R&S	SML03	103330	2010/09/08

Electrical fast transient/burst / SR2

Instrument	Manufacturer	Type No.	Serial No	Cal. Date
Schaffner NSG 2050 System Mainframe	Schaffner	N/A	N/A	2010/01/12

Surge / SR2

Instrument	Manufacturer	Type No.	Serial No	Cal. Date
Schaffner NSG 2050 System Mainframe	Schaffner	N/A	N/A	2010/01/12

Conducted susceptibility / SR6

Instrument	Manufacturer	Type No.	Serial No	Cal. Date
Schaffner NSG 2070 RF-Generator	Schaffner	N/A	N/A	2010/04/21

Power frequency magnetic field / SR3

Instrument	Manufacturer	Type No.	Serial No	Cal. Date
Induction Coil Interface	Schaffner	INA 2141	6002	N/A
Magnetic Loop Coil	Schaffner	INA 702	160	N/A
Triaxial ELF Magnetic Field Meter	F.B.BELL	4090	114135	2010/03/27

Voltage dips and interruption / SR2

Instrument	Manufacturer	Type No.	Serial No	Cal. Date
Schaffner NSG 2050 System Mainframe	Schaffner	N/A	N/A	2010/01/12

Schaffner NSG 2050 System Mainframe				
Instrument	Manufacturer	Type No.	Serial No	Cal. Date
Burst 4.8KV/16A Generator with CDN	Schaffner	PNW2225	200123-098SC	2010/01/15
Damped osc. Wave 100kHz and 1MHz	Schaffner	PNW2056	200124-058SC	2010/01/13
Double AC Source Variator	Schaffner	NSG 642A	30910014938	2010/01/20
Hybrid surge pulse 1.2/50uS	Schaffner	PNW 2050	200532-514LU	2010/01/22
PQT Generator	Schaffner	PNW2003	200138-007SC	2010/01/20
Pulse COUPLING NETWORK	Schaffner	CDN131	200124-007SC	2010/01/22

Schaffner NSG 2070 RF-Generator				
Instrument	Manufacturer	Type No.	Serial No	Cal. Date
CDN	Schaffner	CAL U100A	20405	N/A
CDN	Schaffner	TRA U150	20454	N/A
CDN M016S	Schaffner	CAL U100A	20410	N/A
CDN M016S	Schaffner	TRA U150	21167	N/A
CDN T002	Schaffner	CAL U100	20491	N/A
CDN T002	Schaffner	TRA U150	21169	N/A
CDN T400	Schaffner	CAL U100	17735	N/A
CDN T400	Schaffner	TRA U150	21166	N/A
Coupling Decoupling Network	Schaffner	CDN M016S	20823	2010/04/02
Coupling Decoupling Network	Schaffner	CDN T002	19018	2010/04/02
Coupling Decoupling Network	Schaffner	CDN T400	21226	2010/04/02
EM-CLAMP	Schaffner	KEMZ 801	21024	2010/04/02

2.3. Measurement Uncertainty

Conducted Emission

The measurement uncertainty is evaluated as ± 2.26 dB.

Impedance Stabilization Network

The measurement uncertainty is evaluated as ± 2.26 dB.

Radiated Emission

The measurement uncertainty is evaluated as ± 3.19 dB.

Electrostatic Discharge

As what is concluded in the document from Note2 of clause 5.4.6.2 of ISO/IEC 17025: 1999[2], the requirements for measurement uncertainty in ESD testing are deemed to have been satisfied, and the testing is reported in accordance with the relevant ESD standards. The immunity test signal from the ESD system meet the required specifications in IEC 61000-4-2 through the calibration report with the calibrated uncertainty for the waveform of voltage and timing as being 1.63 % and 2.76%.

Radiated susceptibility

As what is concluded in the document from Note2 of clause 5.4.6.2 of ISO/IEC 17025: 1999[2], the requirements for measurement uncertainty in RS testing are deemed to have been satisfied, and the testing is reported in accordance with the relevant RS standards. The immunity test signal from the RS system meet the required specifications in IEC 61000-4-3 through the calibration for the uniform field strength and monitoring for the test level with the uncertainty evaluation report for the electrical filed strength as being 2.72 dB.

Electrical fast transient/burst

As what is concluded in the document from Note2 of clause 5.4.6.2 of ISO/IEC 17025: 1999[2], the requirements for measurement uncertainty in EFT/Burst testing are deemed to have been satisfied, and the testing is reported in accordance with the relevant EFT/Burst standards. The immunity test signal from the EFT/Burst system meet the required specifications in IEC 61000-4-4 through the calibration report with the calibrated uncertainty for the waveform of voltage, frequency and timing as being 1.63 % and 2.76%.

Surge

As what is concluded in the document from Note2 of clause 5.4.6.2 of ISO/IEC 17025: 1999[2], the requirements for measurement uncertainty in Surge testing are deemed to have been satisfied, and the testing is reported in accordance with the relevant Surge standards. The immunity test signal from the Surge system meet the required specifications in IEC 61000-4-5 through the calibration report with the calibrated uncertainty for the waveform of voltage and timing as being 1.63 % and 2.76%.

Conducted susceptibility

As what is concluded in the document from Note2 of clause 5.4.6.2 of ISO/IEC 17025: 1999[2], the requirements for measurement uncertainty in CS testing are deemed to have been satisfied, and the testing is reported in accordance with the relevant CS standards. The immunity test signal from the CS system meet the required specifications in IEC 61000-4-6 through the calibration for unmodulated signal and monitoring for the test level with the uncertainty evaluation report for the injected modulated signal level through CDN and EM Clamp/Direct Injection as being 3.72 dB and 2.78 dB.

Power frequency magnetic field

As what is concluded in the document from Note2 of clause 5.4.6.2 of ISO/IEC 17025: 1999[2], the requirements for measurement uncertainty in PFM testing are deemed to have been satisfied, and the testing is reported in accordance with the relevant PFM standards. The immunity test signal from the PFM system meet the required specifications in IEC 61000-4-8 through the calibration report with the calibrated uncertainty for the Gauss Meter to verify the output level of magnetic field strength as being 2 %.

Voltage dips and interruption

As what is concluded in the document from Note2 of clause 5.4.6.2 of ISO/IEC 17025: 1999[2], the requirements for measurement uncertainty in DIP testing are deemed to have been satisfied, and the testing is reported in accordance with the relevant DIP standards. The immunity test signal from the DIP system meet the required specifications in IEC 61000-4-11 through the calibration report with the calibrated uncertainty for the waveform of voltage and timing as being 1.63 % and 2.76%.

2.4. Test Environment

Performed Item	Items	Required	Actual
Conducted Emission	Temperature (°C)	15-35	25
	Humidity (%RH)	25-75	50
	Barometric pressure (mbar)	860-1060	950-1000
Impedance Stabilization Network	Temperature (°C)	15-35	25
	Humidity (%RH)	25-75	50
	Barometric pressure (mbar)	860-1060	950-1000
Radiated Emission	Temperature (°C)	15-35	25
	Humidity (%RH)	25-75	50
	Barometric pressure (mbar)	860-1060	950-1000
Electrostatic Discharge	Temperature (°C)	15-35	24
	Humidity (%RH)	30-60	43
	Barometric pressure (mbar)	860-1060	950-1000
Radiated susceptibility	Temperature (°C)	15-35	23
	Humidity (%RH)	25-75	55
	Barometric pressure (mbar)	860-1060	950-1000
Electrical fast transient/burst	Temperature (°C)	15-35	24
	Humidity (%RH)	25-75	55
	Barometric pressure (mbar)	860-1060	950-1000
Surge	Temperature (°C)	15-35	24
	Humidity (%RH)	10-75	55
	Barometric pressure (mbar)	860-1060	950-1000
Conducted susceptibility	Temperature (°C)	15-35	24
	Humidity (%RH)	25-75	43
	Barometric pressure (mbar)	860-1060	950-1000
Power frequency magnetic field	Temperature (°C)	15-35	24
	Humidity (%RH)	25-75	54
	Barometric pressure (mbar)	860-1060	950-1000
Voltage dips and interruption	Temperature (°C)	15-35	24
	Humidity (%RH)	25-75	55
	Barometric pressure (mbar)	860-1060	950-1000

3. Conducted Emission (Main Terminals)

3.1. Test Specification

According to EMC Standard : EN 55022 and AS/NZS CISPR 22

3.2. Test Setup

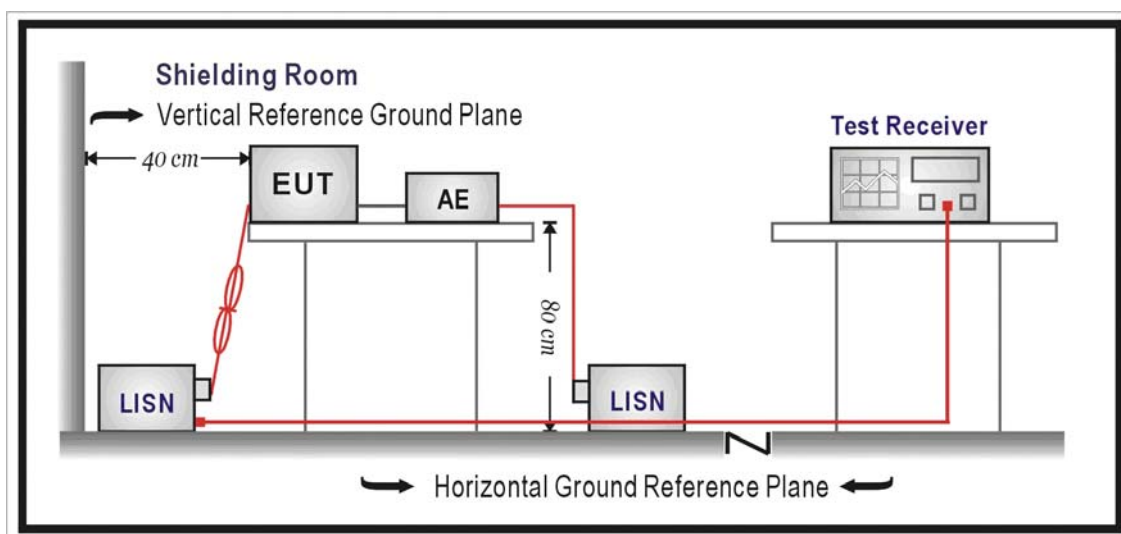

3.3. Limit

Limits		
Frequency (MHz)	QP (dBuV)	AV (dBuV)
0.15 - 0.50	79	66
0.50-5.0	73	60
5.0 - 30	73	60

Remarks: In the above table, the tighter limit applies at the band edges.

3.4. Test Procedure

The EUT and simulators are connected to the main power through a line impedance stabilization network (L.I.S.N.). This provides a 50 ohm /50uH coupling impedance for the measuring equipment. The peripheral devices are also connected to the main power through a LISN that provides a 50ohm/50uH coupling impedance with 50ohm termination.

(Please refers to the block diagram of the test setup and photographs.)

Both sides of A.C. line are checked for maximum conducted interference. In order to find the maximum emission, the relative positions of equipment and all of the interface cables must be changed on conducted measurement.

Conducted emissions were invested over the frequency range from 0.15MHz to 30MHz using a receiver bandwidth of 9kHz.

3.5. Deviation from Test Standard

No deviation.

3.6. Test Result

Site : SR1	Time : 2010/05/20 - 19:21
Limit : CISPR_A_00M_QP	Margin : 10
EUT : Vandal Dome Network Camera	Probe : ENV_216_L1 - Line1
Power : AC 230V/50Hz	Note : Mode 1



Site : SR1	Time : 2010/05/20 - 19:23
Limit : CISPR_A_00M_QP	Margin : 0
EUT : Vandal Dome Network Camera	Probe : ENV_216_L1 - Line1
Power : AC 230V/50Hz	Note : Mode 1

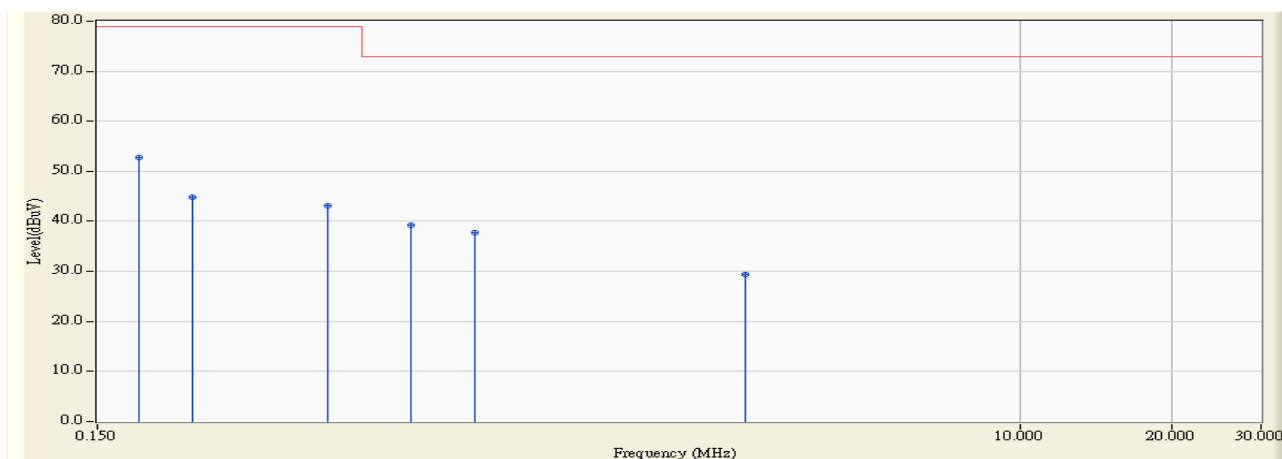

		Frequency (MHz)	Correct Factor (dB)	Reading Level (dBuV)	Measure Level (dBuV)	Margin (dB)	Limit (dBuV)	Detector Type
1	*	0.181	9.790	42.880	52.670	-26.330	79.000	QUASIPeAK
2		0.232	9.790	34.980	44.770	-34.230	79.000	QUASIPeAK
3		0.427	9.790	33.390	43.180	-35.820	79.000	QUASIPeAK
4		0.627	9.790	29.470	39.260	-33.740	73.000	QUASIPeAK
5		0.834	9.800	27.940	37.740	-35.260	73.000	QUASIPeAK
6		2.865	9.810	19.630	29.440	-43.560	73.000	QUASIPeAK

Note:

1. All Reading Levels are Quasi-Peak and average value.
2. " * ", means this data is the worst emission level.
3. Measurement Level = Reading Level + Correct Factor

Site : SR1	Time : 2010/05/20 - 19:23
Limit : CISPR_A_00M_AV	Margin : 0
EUT : Vandal Dome Network Camera	Probe : ENV_216_L1 - Line1
Power : AC 230V/50Hz	Note : Mode 1

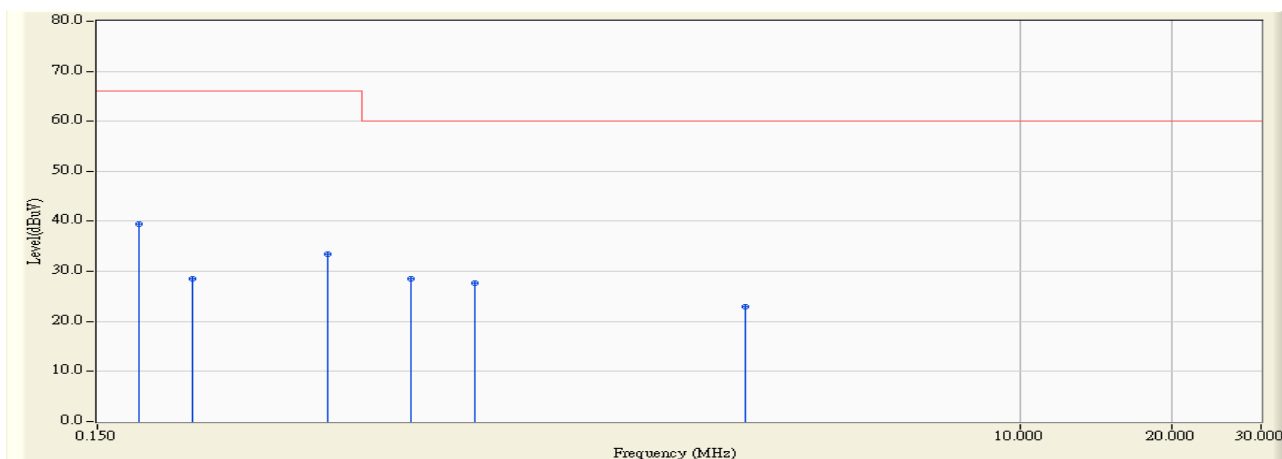

		Frequency (MHz)	Correct Factor (dB)	Reading Level (dBuV)	Measure Level (dBuV)	Margin (dB)	Limit (dBuV)	Detector Type
1	*	0.181	9.790	29.750	39.540	-26.460	66.000	AVERAGE
2		0.232	9.790	18.800	28.590	-37.410	66.000	AVERAGE
3		0.427	9.790	23.580	33.370	-32.630	66.000	AVERAGE
4		0.627	9.790	18.670	28.460	-31.540	60.000	AVERAGE
5		0.834	9.800	17.870	27.670	-32.330	60.000	AVERAGE
6		2.865	9.810	13.220	23.030	-36.970	60.000	AVERAGE

Note:

1. All Reading Levels are Quasi-Peak and average value.
2. " * ", means this data is the worst emission level.
3. Measurement Level = Reading Level + Correct Factor

Site : SR1	Time : 2010/05/20 - 19:25
Limit : CISPR_A_00M_QP	Margin : 10
EUT : Vandal Dome Network Camera	Probe : ENV_216_N - Line2
Power : AC 230V/50Hz	Note : Mode 1

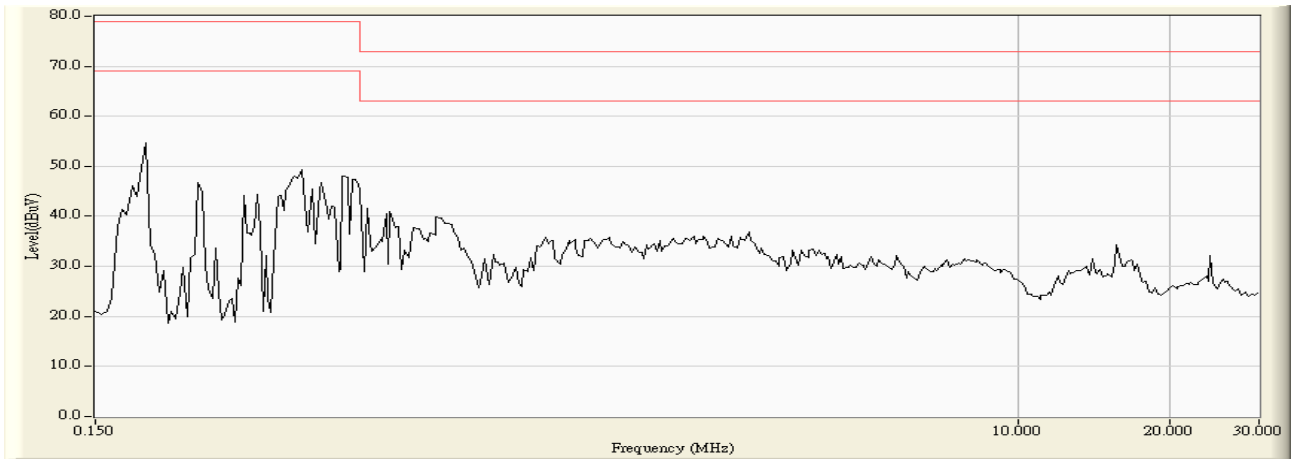

Site : SR1	Time : 2010/05/20 - 19:27
Limit : CISPR_A_00M_QP	Margin : 0
EUT : Vandal Dome Network Camera	Probe : ENV_216_N - Line2
Power : AC 230V/50Hz	Note : Mode 1

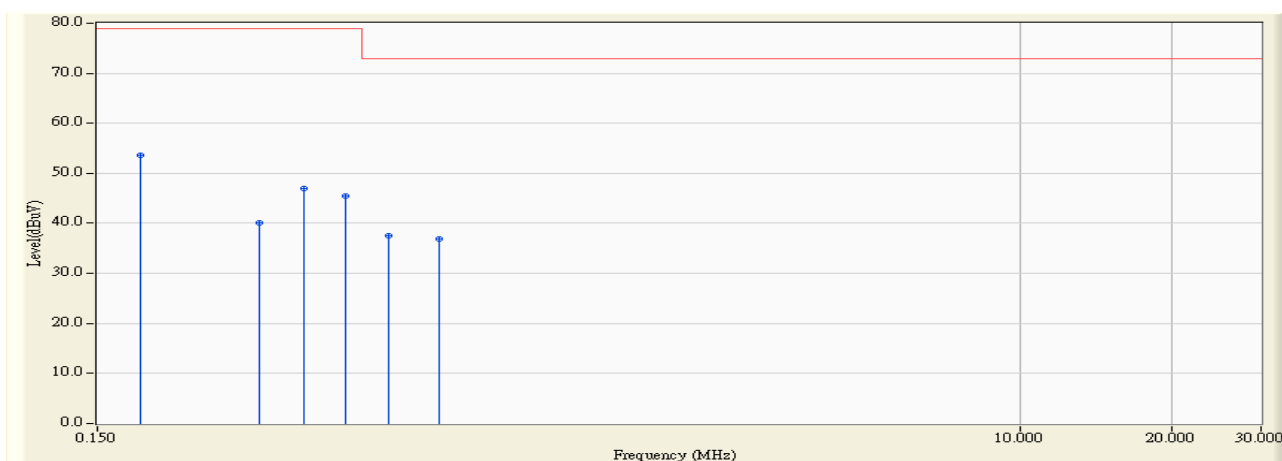

		Frequency (MHz)	Correct Factor (dB)	Reading Level (dBuV)	Measure Level (dBuV)	Margin (dB)	Limit (dBuV)	Detector Type
1	*	0.183	9.780	43.910	53.690	-25.310	79.000	QUASIPeAK
2		0.314	9.790	30.290	40.080	-38.920	79.000	QUASIPeAK
3		0.384	9.790	37.230	47.020	-31.980	79.000	QUASIPeAK
4		0.463	9.790	35.660	45.450	-33.550	79.000	QUASIPeAK
5		0.564	9.790	27.830	37.620	-35.380	73.000	QUASIPeAK
6		0.709	9.790	27.190	36.980	-36.020	73.000	QUASIPeAK

Note:

1. All Reading Levels are Quasi-Peak and average value.
2. " * ", means this data is the worst emission level.
3. Measurement Level = Reading Level + Correct Factor

Site : SR1	Time : 2010/05/20 - 19:27
Limit : CISPR_A_00M_AV	Margin : 0
EUT : Vandal Dome Network Camera	Probe : ENV_216_N - Line2
Power : AC 230V/50Hz	Note : Mode 1

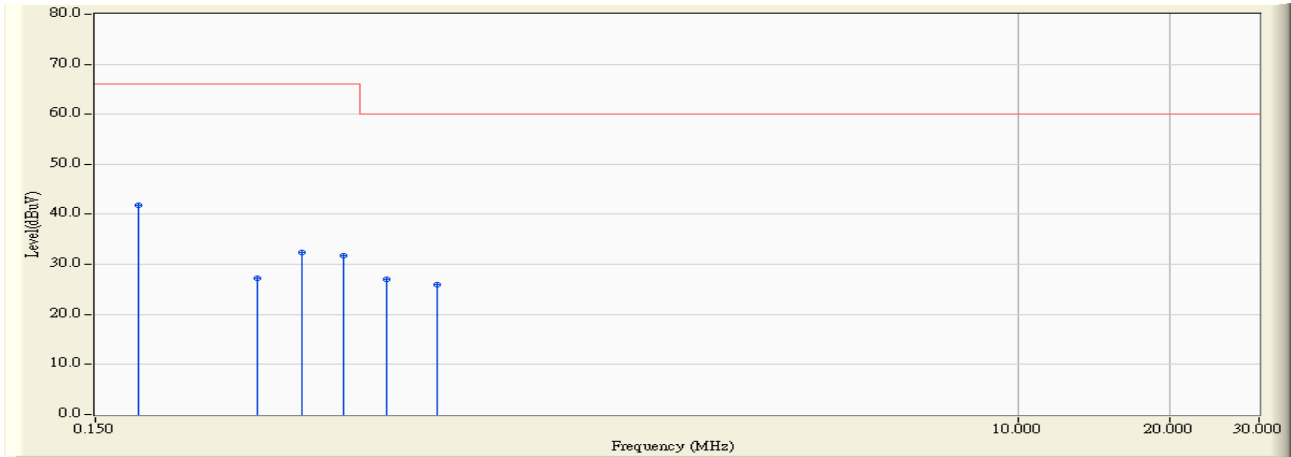

		Frequency (MHz)	Correct Factor (dB)	Reading Level (dBuV)	Measure Level (dBuV)	Margin (dB)	Limit (dBuV)	Detector Type
1	*	0.183	9.780	32.150	41.930	-24.070	66.000	AVERAGE
2		0.314	9.790	17.440	27.230	-38.770	66.000	AVERAGE
3		0.384	9.790	22.650	32.440	-33.560	66.000	AVERAGE
4		0.463	9.790	21.970	31.760	-34.240	66.000	AVERAGE
5		0.564	9.790	17.160	26.950	-33.050	60.000	AVERAGE
6		0.709	9.790	16.200	25.990	-34.010	60.000	AVERAGE

Note:

1. All Reading Levels are Quasi-Peak and average value.
2. " * ", means this data is the worst emission level.
3. Measurement Level = Reading Level + Correct Factor

Site : SR1	Time : 2010/05/20 - 19:35
Limit : CISPR_A_00M_QP	Margin : 10
EUT : Vandal Dome Network Camera	Probe : ENV_216_L1 - Line1
Power : AC 230V/50Hz	Note : Mode 2

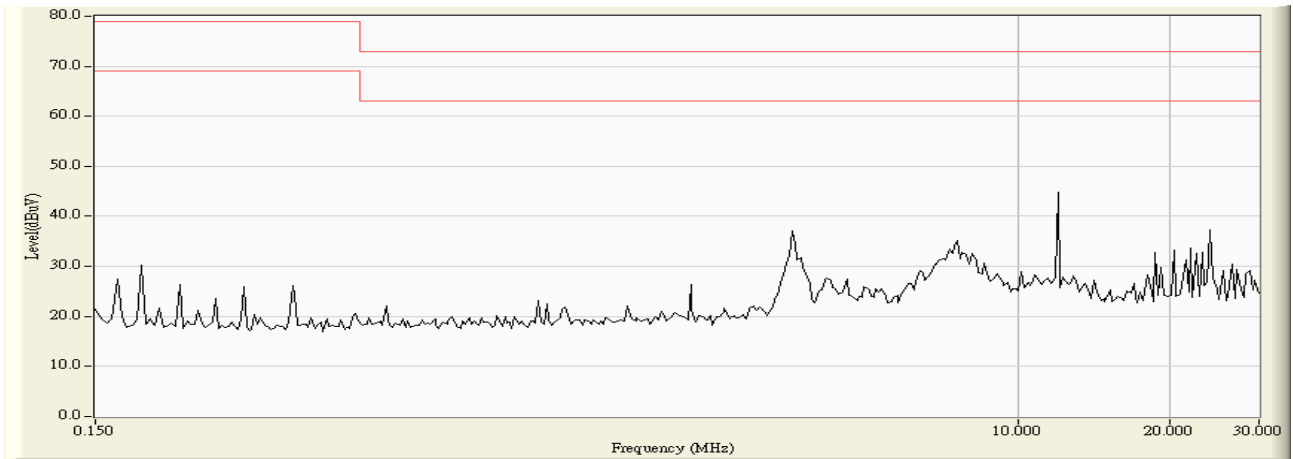

Site : SR1	Time : 2010/05/20 - 19:37
Limit : CISPR_A_00M_QP	Margin : 0
EUT : Vandal Dome Network Camera	Probe : ENV_216_L1 - Line1
Power : AC 230V/50Hz	Note : Mode 2

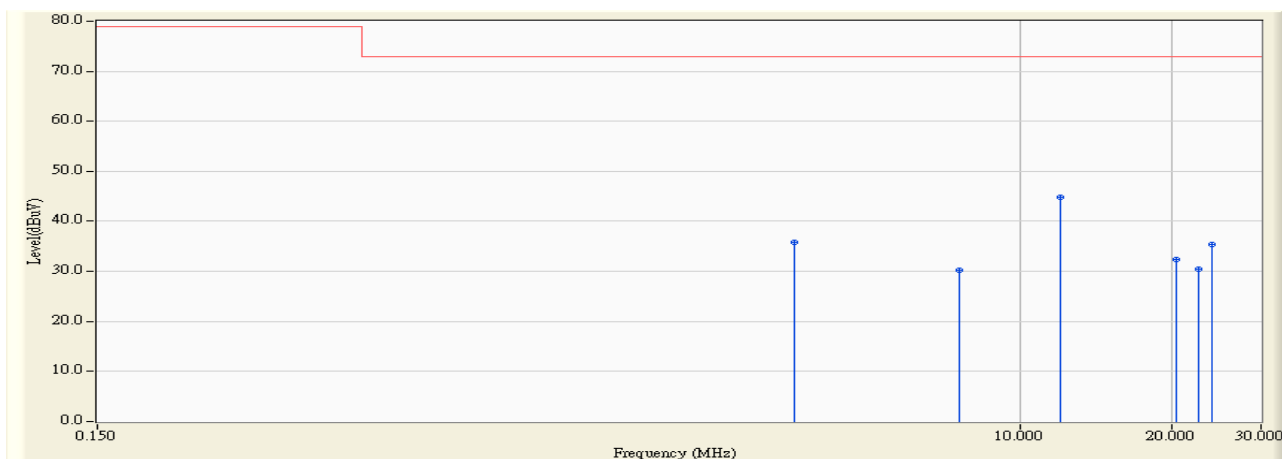

		Frequency (MHz)	Correct Factor (dB)	Reading Level (dBuV)	Measure Level (dBuV)	Margin (dB)	Limit (dBuV)	Detector Type
1		3.580	9.820	25.920	35.740	-37.260	73.000	QUASPEAK
2		7.595	9.860	20.460	30.320	-42.680	73.000	QUASPEAK
3	*	12.000	9.967	34.920	44.887	-28.113	73.000	QUASPEAK
4		20.349	10.110	22.280	32.390	-40.610	73.000	QUASPEAK
5		22.611	10.130	20.230	30.360	-42.640	73.000	QUASPEAK
6		23.998	10.130	25.170	35.300	-37.700	73.000	QUASPEAK

Note:

1. All Reading Levels are Quasi-Peak and average value.
2. " * ", means this data is the worst emission level.
3. Measurement Level = Reading Level + Correct Factor

Site : SR1	Time : 2010/05/20 - 19:37
Limit : CISPR_A_00M_AV	Margin : 0
EUT : Vandal Dome Network Camera	Probe : ENV_216_L1 - Line1
Power : AC 230V/50Hz	Note : Mode 2

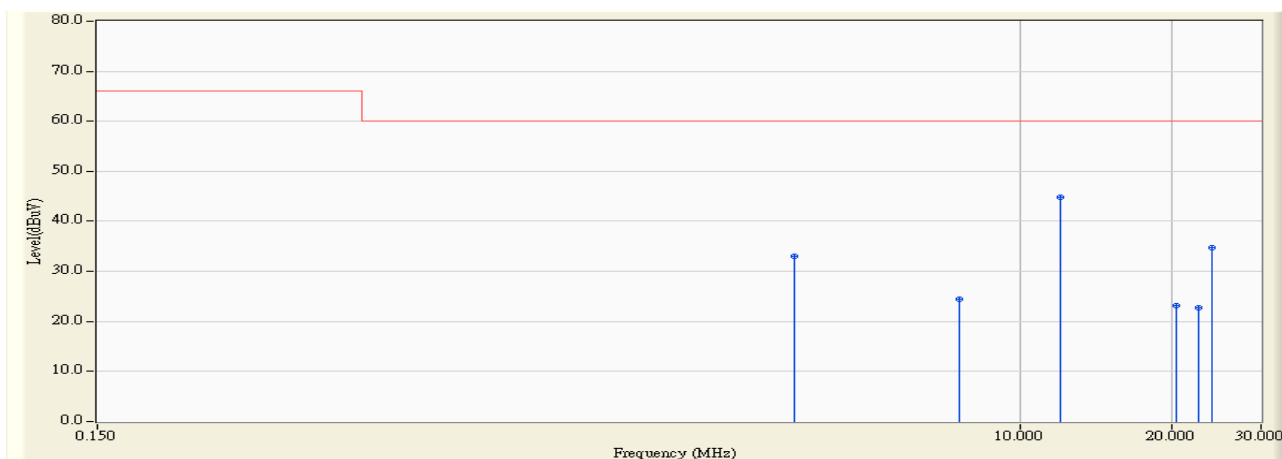

	Frequency (MHz)	Correct Factor (dB)	Reading Level (dBuV)	Measure Level (dBuV)	Margin (dB)	Limit (dBuV)	Detector Type
1	3.580	9.820	23.290	33.110	-26.890	60.000	AVERAGE
2	7.595	9.860	14.670	24.530	-35.470	60.000	AVERAGE
3	* 12.000	9.967	34.910	44.877	-15.123	60.000	AVERAGE
4	20.349	10.110	13.060	23.170	-36.830	60.000	AVERAGE
5	22.611	10.130	12.590	22.720	-37.280	60.000	AVERAGE
6	23.998	10.130	24.510	34.640	-25.360	60.000	AVERAGE

Note:

1. All Reading Levels are Quasi-Peak and average value.
2. " * ", means this data is the worst emission level.
3. Measurement Level = Reading Level + Correct Factor

Site : SR1	Time : 2010/05/20 - 19:38
Limit : CISPR_A_00M_QP	Margin : 10
EUT : Vandal Dome Network Camera	Probe : ENV_216_N - Line2
Power : AC 230V/50Hz	Note : Mode 2

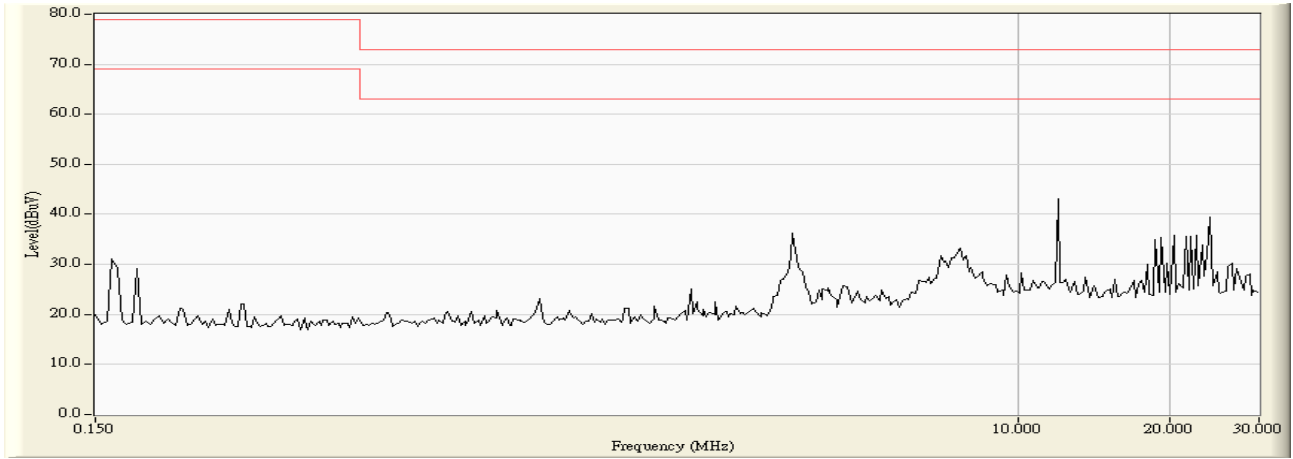

Site : SR1	Time : 2010/05/20 - 19:40
Limit : CISPR_A_00M_QP	Margin : 0
EUT : Vandal Dome Network Camera	Probe : ENV_216_N - Line2
Power : AC 230V/50Hz	Note : Mode 2

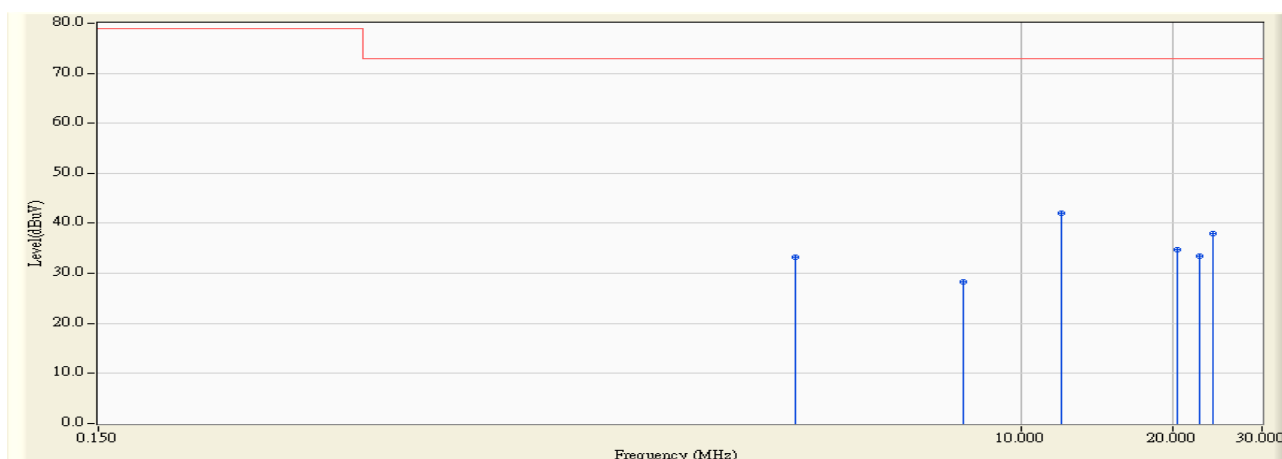

		Frequency (MHz)	Correct Factor (dB)	Reading Level (dBuV)	Measure Level (dBuV)	Margin (dB)	Limit (dBuV)	Detector Type
1		3.580	9.820	23.510	33.330	-39.670	73.000	QUASIPeAK
2		7.685	9.870	18.480	28.350	-44.650	73.000	QUASIPeAK
3	*	12.002	10.007	32.000	42.007	-30.993	73.000	QUASIPeAK
4		20.349	10.230	24.560	34.790	-38.210	73.000	QUASIPeAK
5		22.607	10.260	23.280	33.540	-39.460	73.000	QUASIPeAK
6		24.002	10.280	27.600	37.880	-35.120	73.000	QUASIPeAK

Note:

1. All Reading Levels are Quasi-Peak and average value.
2. " * ", means this data is the worst emission level.
3. Measurement Level = Reading Level + Correct Factor

Site : SR1	Time : 2010/05/20 - 19:40
Limit : CISPR_A_00M_AV	Margin : 0
EUT : Vandal Dome Network Camera	Probe : ENV_216_N - Line2
Power : AC 230V/50Hz	Note : Mode 2

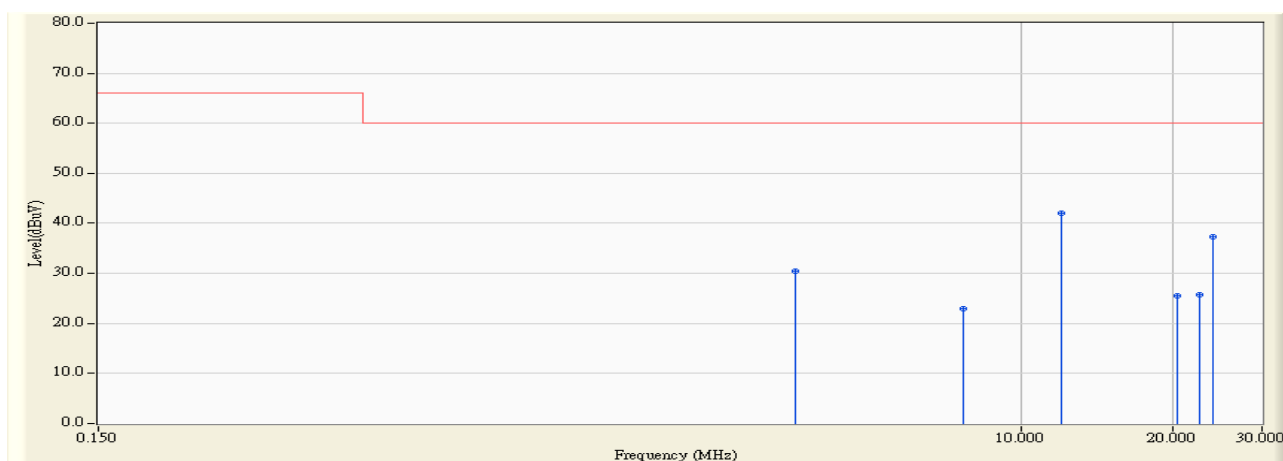

	Frequency (MHz)	Correct Factor (dB)	Reading Level (dBuV)	Measure Level (dBuV)	Margin (dB)	Limit (dBuV)	Detector Type
1	3.580	9.820	20.680	30.500	-29.500	60.000	AVERAGE
2	7.685	9.870	12.980	22.850	-37.150	60.000	AVERAGE
3	* 12.002	10.007	31.990	41.997	-18.003	60.000	AVERAGE
4	20.349	10.230	15.290	25.520	-34.480	60.000	AVERAGE
5	22.607	10.260	15.390	25.650	-34.350	60.000	AVERAGE
6	24.002	10.280	27.030	37.310	-22.690	60.000	AVERAGE

Note:

1. All Reading Levels are Quasi-Peak and average value.
2. " * ", means this data is the worst emission level.
3. Measurement Level = Reading Level + Correct Factor

3.7. Test Photograph

Test Mode : Mode 1: Normal Operation (Adapter: 3A-183WP12)

Description : Front View of Conducted Test



Test Mode : Mode 1: Normal Operation (Adapter: 3A-183WP12)

Description : Back View of Conducted Test



Test Mode : Mode 2: Normal Operation (AC 24V)

Description : Front View of Conducted Test



Test Mode : Mode 2: Normal Operation (AC 24V)

Description : Back View of Conducted Test



4. Conducted Emissions (Telecommunication Ports)

4.1. Test Specification

According to EMC Standard : EN 55022 and AS/NZS CISPR 22

4.2. Test Setup

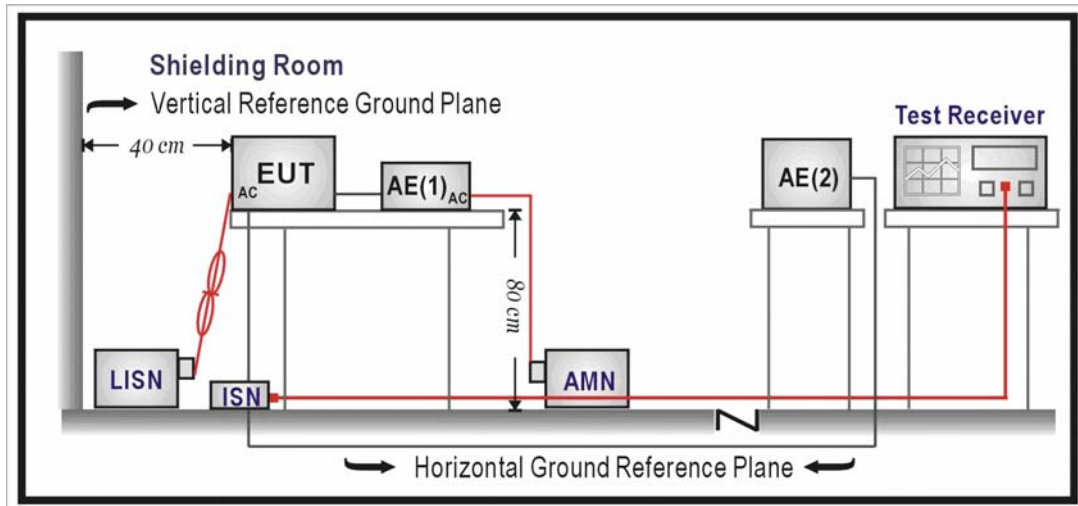

4.3. Limit

Limits		
Frequency (MHz)	QP (dBuV)	AV (dBuV)
0.15 - 0.50	97 – 87	84 – 74
0.50 - 30	87	74

Remarks:

The limit decreases linearly with the logarithm of the frequency in the range 0.15 MHz~0.50 MHz.

4.4. Test Procedure

Telecommunication Port:

The mains voltage shall be supplied to the EUT via the LISN when the measurement of telecommunication port is performed. The common mode disturbances at the telecommunication port shall be connected to the ISN, which is 150 ohm impedance.

Both alternative cables are tested related to the LCL requested. The measurement range is from 150kHz to 30MHz. The bandwidth of measurement is set to 9kHz.

The 75dB LCL ISN is used for cat. 6 cable, the 65dB LCL ISN is used for cat. 5 cable, 55dB LCL ISN is used for cat. 3.

4.5. Deviation from Test Standard

No deviation.

4.6. Test Result

Site : SR1	Time : 2010/05/25 - 20:41
Limit : ISN_Voltage_A_00M_QP	Margin : 10
EUT : Network Camera	Probe : ISN_T4 - Line1
Power : AC 230V/50Hz	Note : Mode 1, ISN 10Mbps

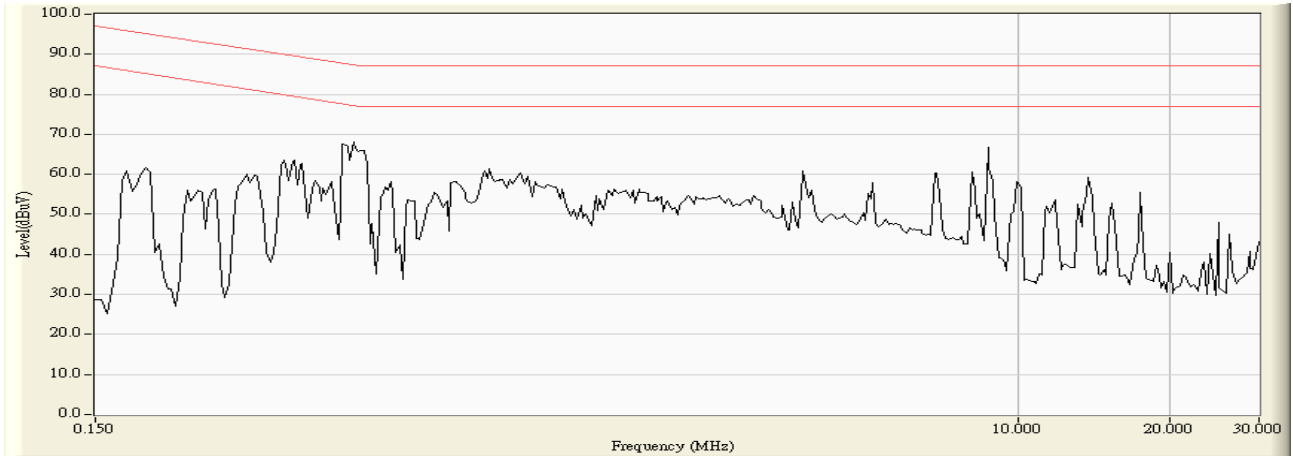

Site : SR1	Time : 2010/05/25 - 20:42
Limit : ISN_Voltage_A_00M_QP	Margin : 0
EUT : Network Camera	Probe : ISN_T4 - Line1
Power : AC 230V/50Hz	Note : Mode 1, ISN 10Mbps

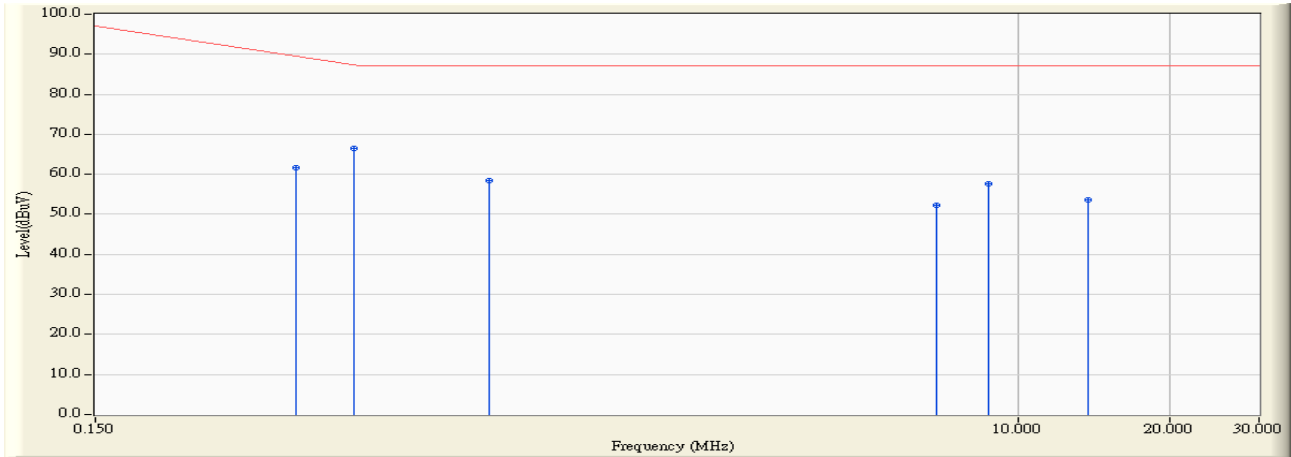

		Frequency (MHz)	Correct Factor (dB)	Reading Level (dBuV)	Measure Level (dBuV)	Margin (dB)	Limit (dBuV)	Detector Type
1		0.373	10.005	51.720	61.725	-28.904	90.629	QUASIPeAK
2	*	0.486	9.990	56.370	66.360	-21.040	87.400	QUASIPeAK
3		0.900	9.980	48.450	58.430	-28.570	87.000	QUASIPeAK
4		6.904	9.970	42.200	52.170	-34.830	87.000	QUASIPeAK
5		8.752	9.968	47.600	57.568	-29.432	87.000	QUASIPeAK
6		13.752	10.143	43.570	53.713	-33.287	87.000	QUASIPeAK

Note:

1. All Reading Levels are Quasi-Peak and average value.
2. " * ", means this data is the worst emission level.
3. Measurement Level = Reading Level + Correct Factor

Site : SR1	Time : 2010/05/25 - 20:42
Limit : ISN_Voltage_A_00M_AV	Margin : 0
EUT : Network Camera	Probe : ISN_T4 - Line1
Power : AC 230V/50Hz	Note : Mode 1, ISN 10Mbps

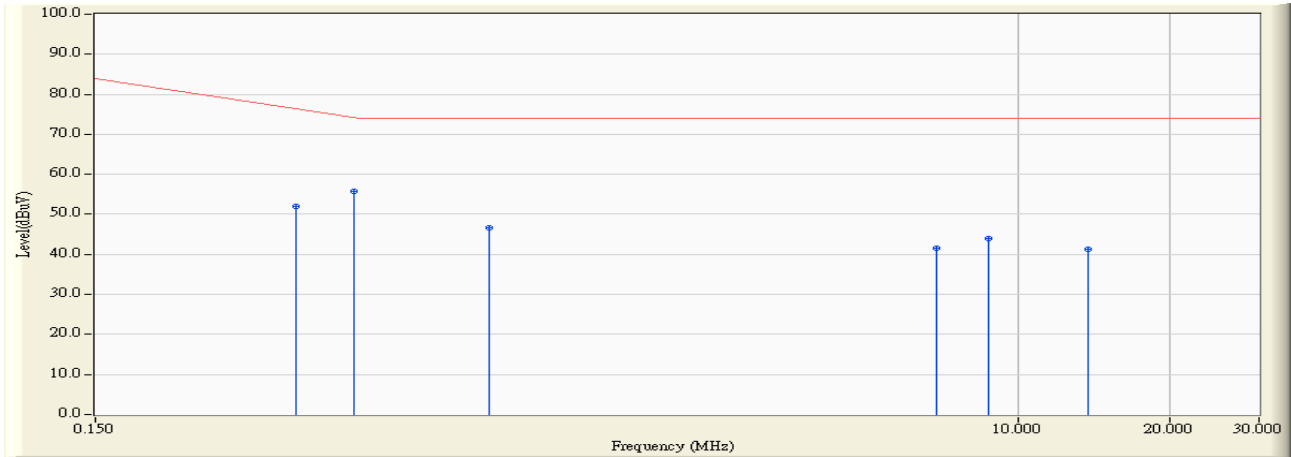

		Frequency (MHz)	Correct Factor (dB)	Reading Level (dBuV)	Measure Level (dBuV)	Margin (dB)	Limit (dBuV)	Detector Type
1		0.373	10.005	41.880	51.885	-25.744	77.629	AVERAGE
2	*	0.486	9.990	45.650	55.640	-18.760	74.400	AVERAGE
3		0.900	9.980	36.550	46.530	-27.470	74.000	AVERAGE
4		6.904	9.970	31.600	41.570	-32.430	74.000	AVERAGE
5		8.752	9.968	34.080	44.048	-29.952	74.000	AVERAGE
6		13.752	10.143	31.090	41.233	-32.767	74.000	AVERAGE

Note:

1. All Reading Levels are Quasi-Peak and average value.
2. " * ", means this data is the worst emission level.
3. Measurement Level = Reading Level + Correct Factor

Site : SR1	Time : 2010/05/25 - 20:36
Limit : ISN_Voltage_A_00M_QP	Margin : 10
EUT : Network Camera	Probe : ISN_T4 - Line1
Power : AC 230V/50Hz	Note : Mode 1, ISN 100Mbps

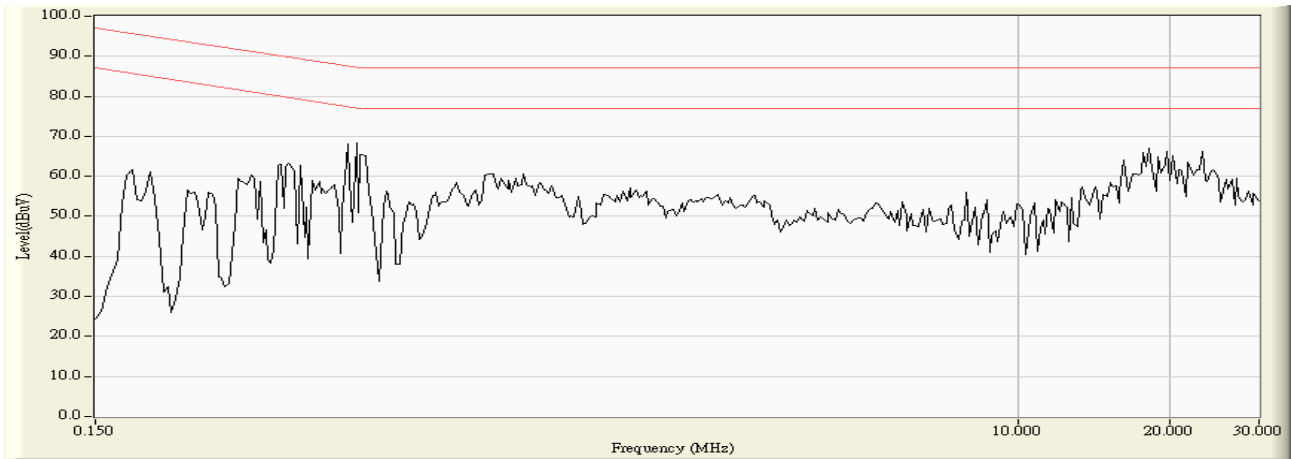

Site : SR1	Time : 2010/05/25 - 20:38
Limit : ISN_Voltage_A_00M_QP	Margin : 0
EUT : Network Camera	Probe : ISN_T4 - Line1
Power : AC 230V/50Hz	Note : Mode 1, ISN 100Mbps

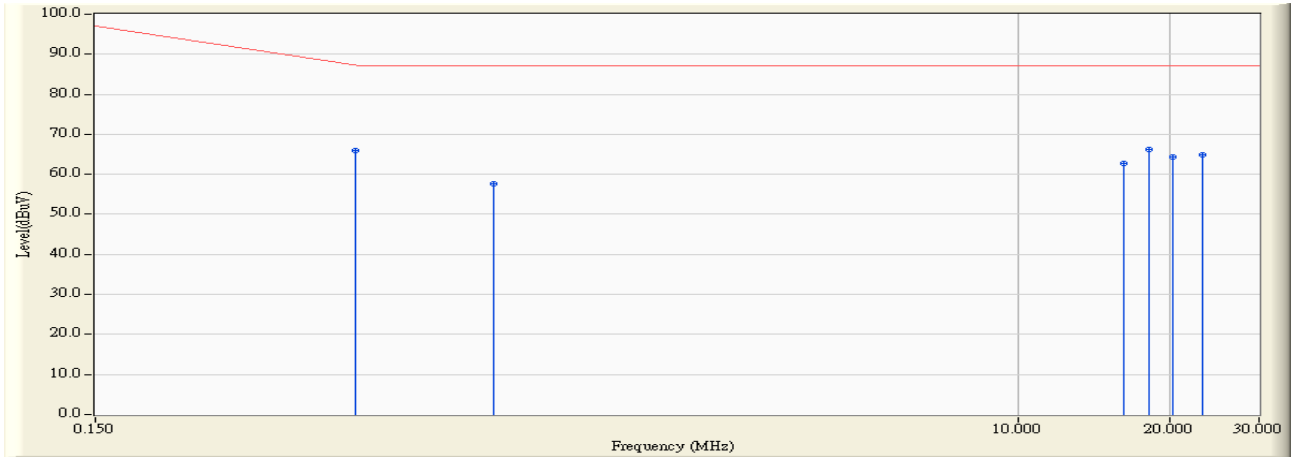

		Frequency (MHz)	Correct Factor (dB)	Reading Level (dBuV)	Measure Level (dBuV)	Margin (dB)	Limit (dBuV)	Detector Type
1		0.490	9.990	55.940	65.930	-21.356	87.286	QUASIPeAK
2		0.920	9.980	47.540	57.520	-29.480	87.000	QUASIPeAK
3		16.228	10.130	52.580	62.710	-24.290	87.000	QUASIPeAK
4	*	18.244	10.120	55.990	66.110	-20.890	87.000	QUASIPeAK
5		20.259	10.110	54.110	64.220	-22.780	87.000	QUASIPeAK
6		23.130	10.100	54.910	65.010	-21.990	87.000	QUASIPeAK

Note:

1. All Reading Levels are Quasi-Peak and average value.
2. " * ", means this data is the worst emission level.
3. Measurement Level = Reading Level + Correct Factor

Site : SR1	Time : 2010/05/25 - 20:38
Limit : ISN_Voltage_A_00M_AV	Margin : 0
EUT : Network Camera	Probe : ISN_T4 - Line1
Power : AC 230V/50Hz	Note : Mode 1, ISN 100Mbps

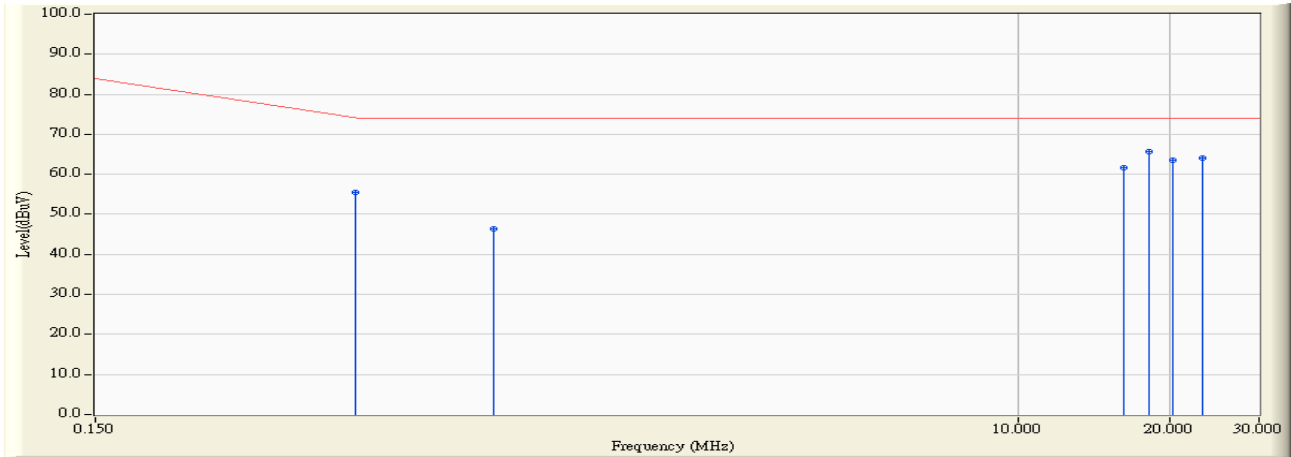

		Frequency (MHz)	Correct Factor (dB)	Reading Level (dBuV)	Measure Level (dBuV)	Margin (dB)	Limit (dBuV)	Detector Type
1		0.490	9.990	45.470	55.460	-18.826	74.286	AVERAGE
2		0.920	9.980	36.460	46.440	-27.560	74.000	AVERAGE
3		16.228	10.130	51.420	61.550	-12.450	74.000	AVERAGE
4	*	18.244	10.120	55.460	65.580	-8.420	74.000	AVERAGE
5		20.259	10.110	53.530	63.640	-10.360	74.000	AVERAGE
6		23.130	10.100	53.950	64.050	-9.950	74.000	AVERAGE

Note:

1. All Reading Levels are Quasi-Peak and average value.
2. " * ", means this data is the worst emission level.
3. Measurement Level = Reading Level + Correct Factor

Site : SR1	Time : 2010/05/25 - 20:45
Limit : ISN_Voltage_A_00M_QP	Margin : 10
EUT : Vandal Dome Network Camera	Probe : ISN_T4 - Line1
Power : AC 230V/50Hz	Note : Mode 2, ISN 10Mbps

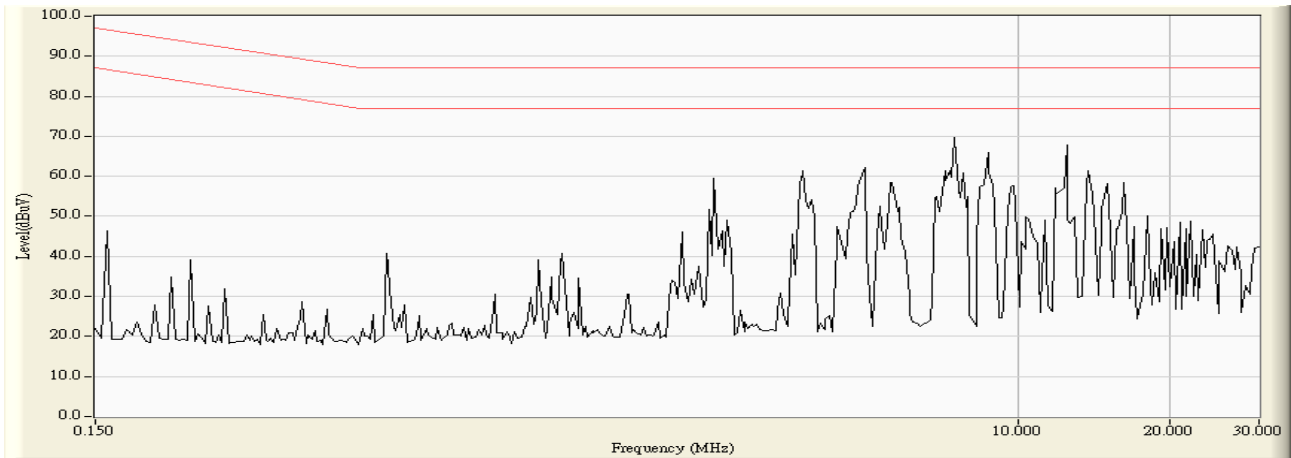

Site : SR1	Time : 2010/05/25 - 20:47
Limit : ISN_Voltage_A_00M_QP	Margin : 0
EUT : Vandal Dome Network Camera	Probe : ISN_T4 - Line1
Power : AC 230V/50Hz	Note : Mode 2, ISN 10Mbps

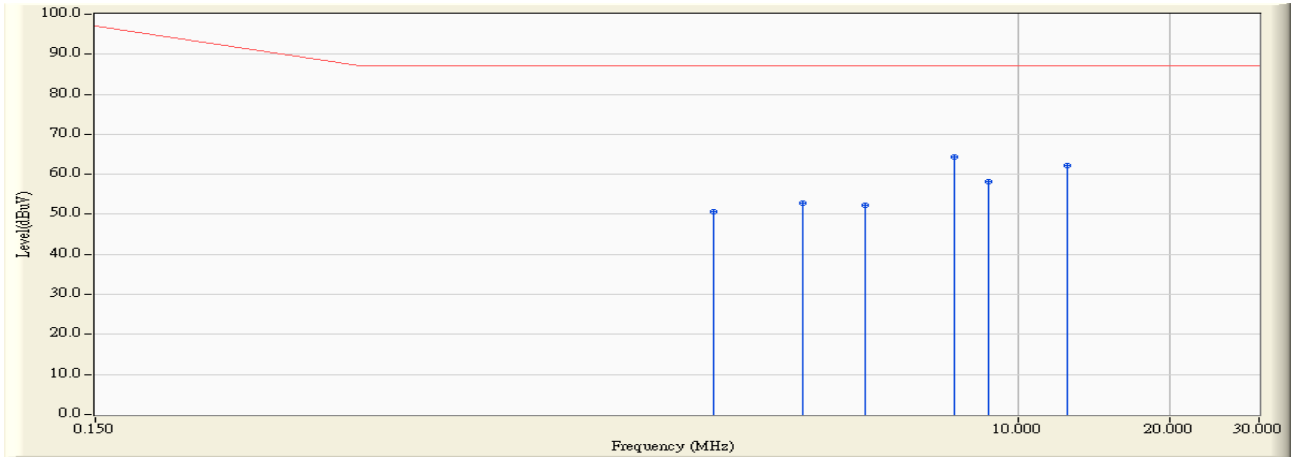

		Frequency (MHz)	Correct Factor (dB)	Reading Level (dBuV)	Measure Level (dBuV)	Margin (dB)	Limit (dBuV)	Detector Type
1		2.502	10.000	40.710	50.710	-36.290	87.000	QUASIPeAK
2		3.752	9.990	42.910	52.900	-34.100	87.000	QUASIPeAK
3		4.998	9.980	42.290	52.270	-34.730	87.000	QUASIPeAK
4	*	7.502	9.970	54.470	64.440	-22.560	87.000	QUASIPeAK
5		8.752	9.968	48.210	58.178	-28.822	87.000	QUASIPeAK
6		12.502	10.073	52.060	62.133	-24.867	87.000	QUASIPeAK

Note:

1. All Reading Levels are Quasi-Peak and average value.
2. " * ", means this data is the worst emission level.
3. Measurement Level = Reading Level + Correct Factor

Site : SR1	Time : 2010/05/25 - 20:47
Limit : ISN_Voltage_A_00M_AV	Margin : 0
EUT : Vandal Dome Network Camera	Probe : ISN_T4 - Line1
Power : AC 230V/50Hz	Note : Mode 2, ISN 10Mbps

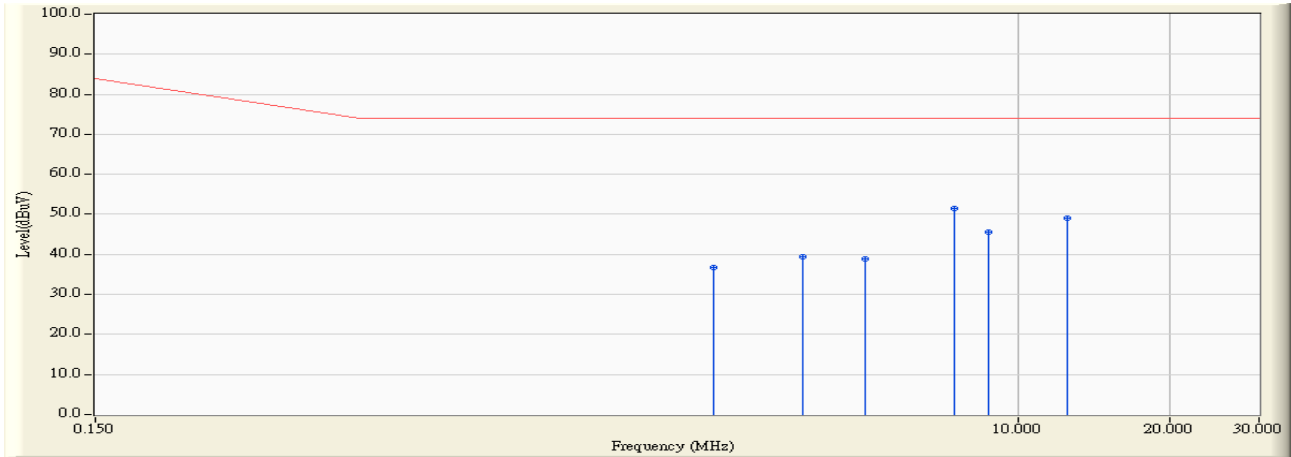

		Frequency (MHz)	Correct Factor (dB)	Reading Level (dBuV)	Measure Level (dBuV)	Margin (dB)	Limit (dBuV)	Detector Type
1		2.502	10.000	26.720	36.720	-37.280	74.000	AVERAGE
2		3.752	9.990	29.360	39.350	-34.650	74.000	AVERAGE
3		4.998	9.980	28.930	38.910	-35.090	74.000	AVERAGE
4	*	7.502	9.970	41.510	51.480	-22.520	74.000	AVERAGE
5		8.752	9.968	35.630	45.598	-28.402	74.000	AVERAGE
6		12.502	10.073	38.920	48.993	-25.007	74.000	AVERAGE

Note:

1. All Reading Levels are Quasi-Peak and average value.
2. " * ", means this data is the worst emission level.
3. Measurement Level = Reading Level + Correct Factor

Site : SR1	Time : 2010/05/25 - 20:48
Limit : ISN_Voltage_A_00M_QP	Margin : 10
EUT : Vandal Dome Network Camera	Probe : ISN_T4 - Line1
Power : AC 230V/50Hz	Note : Mode 2, ISN 100Mbps

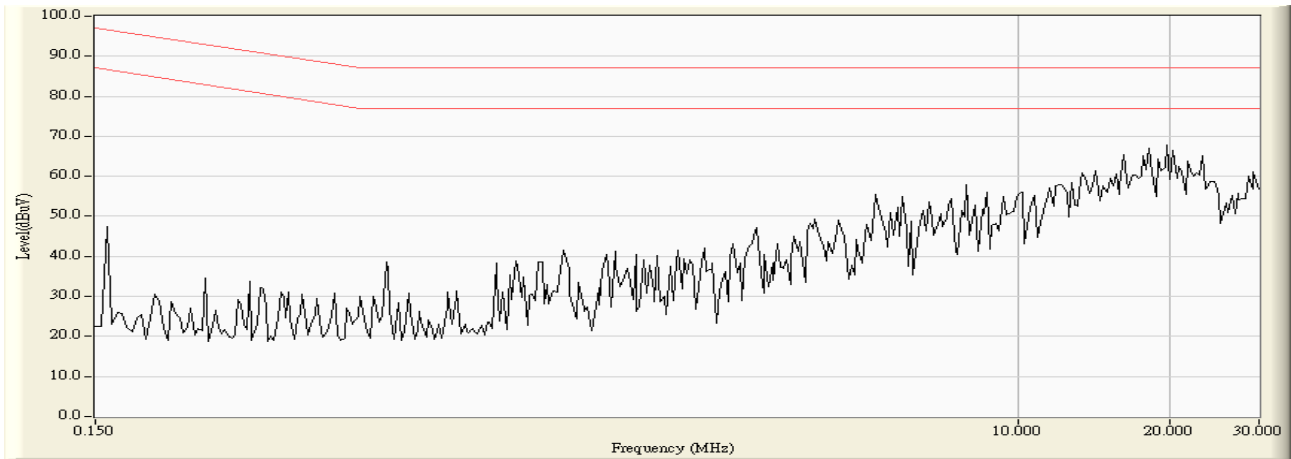

Site : SR1	Time : 2010/05/25 - 20:49
Limit : ISN_Voltage_A_00M_QP	Margin : 0
EUT : Vandal Dome Network Camera	Probe : ISN_T4 - Line1
Power : AC 230V/50Hz	Note : Mode 2, ISN 100Mbps

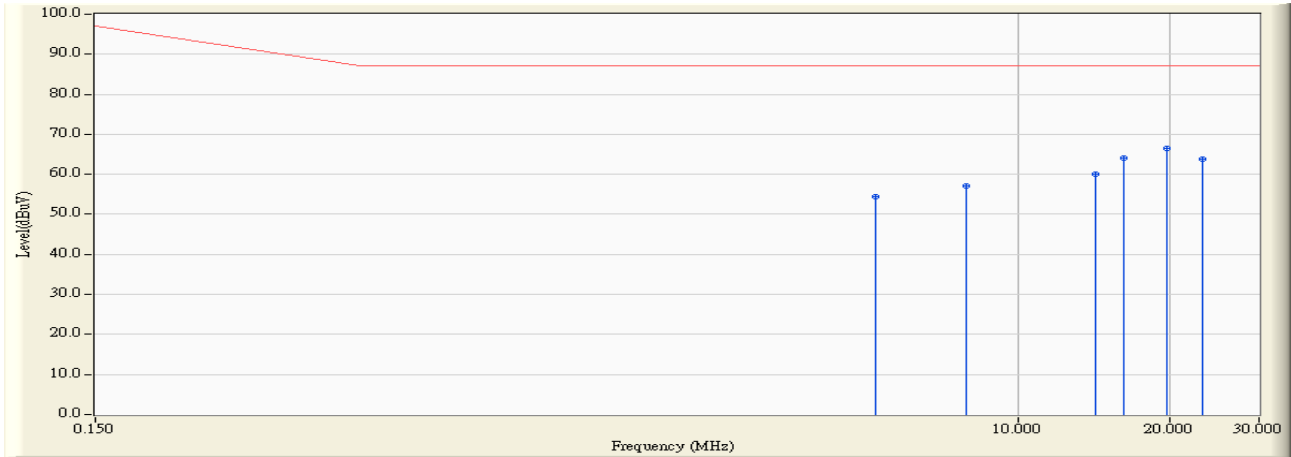

	Frequency (MHz)	Correct Factor (dB)	Reading Level (dBuV)	Measure Level (dBuV)	Margin (dB)	Limit (dBuV)	Detector Type
1	5.236	9.980	44.460	54.440	-32.560	87.000	QUASIPeAK
2	7.923	9.970	47.040	57.010	-29.990	87.000	QUASIPeAK
3	14.213	10.140	49.840	59.980	-27.020	87.000	QUASIPeAK
4	16.228	10.130	54.040	64.170	-22.830	87.000	QUASIPeAK
5	* 19.710	10.110	56.490	66.600	-20.400	87.000	QUASIPeAK
6	23.130	10.100	53.580	63.680	-23.320	87.000	QUASIPeAK

Note:

1. All Reading Levels are Quasi-Peak and average value.
2. " * ", means this data is the worst emission level.
3. Measurement Level = Reading Level + Correct Factor

Site : SR1	Time : 2010/05/25 - 20:49
Limit : ISN_Voltage_A_00M_AV	Margin : 0
EUT : Vandal Dome Network Camera	Probe : ISN_T4 - Line1
Power : AC 230V/50Hz	Note : Mode 2, ISN 100Mbps

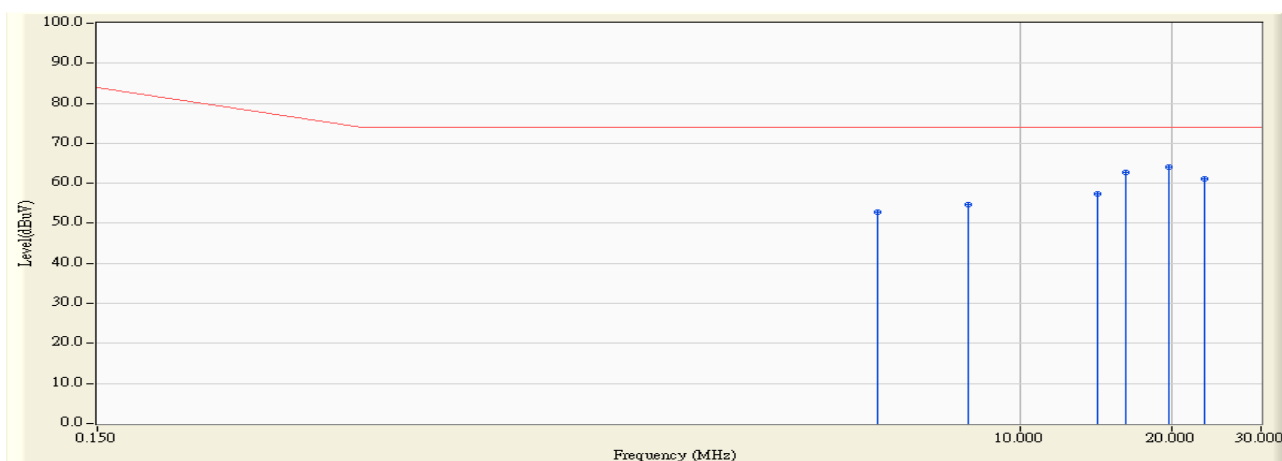

		Frequency (MHz)	Correct Factor (dB)	Reading Level (dBuV)	Measure Level (dBuV)	Margin (dB)	Limit (dBuV)	Detector Type
1		5.236	9.980	42.830	52.810	-21.190	74.000	AVERAGE
2		7.923	9.970	44.750	54.720	-19.280	74.000	AVERAGE
3		14.213	10.140	47.360	57.500	-16.500	74.000	AVERAGE
4		16.228	10.130	52.640	62.770	-11.230	74.000	AVERAGE
5	*	19.710	10.110	53.880	63.990	-10.010	74.000	AVERAGE
6		23.130	10.100	51.120	61.220	-12.780	74.000	AVERAGE

Note:

1. All Reading Levels are Quasi-Peak and average value.
2. " * ", means this data is the worst emission level.
3. Measurement Level = Reading Level + Correct Factor

Site : SR1	Time : 2010/05/20 - 14:58
Limit : ISN_Voltage_A_00M_QP	Margin : 10
EUT : Vandal Dome Network Camera	Probe : CVP-2200A - Line1
Power : By PoE	Note : Mode 3, ISN 10Mbps

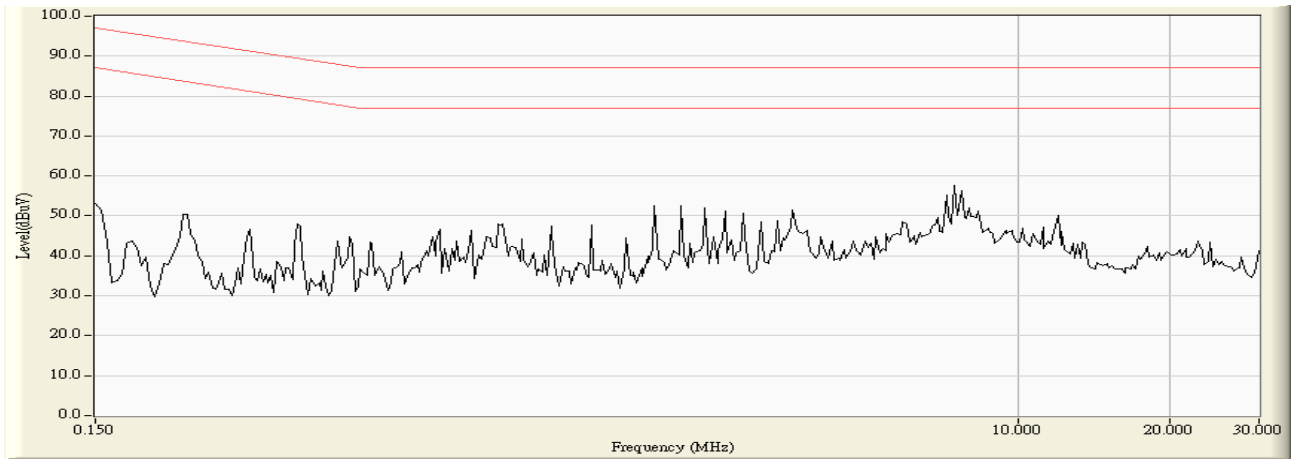

Site : SR1	Time : 2010/05/20 - 14:58
Limit : ISN_Voltage_A_00M_QP	Margin : 0
EUT : Vandal Dome Network Camera	Probe : CVP-2200A - Line1
Power : By PoE	Note : Mode 3, ISN 10Mbps

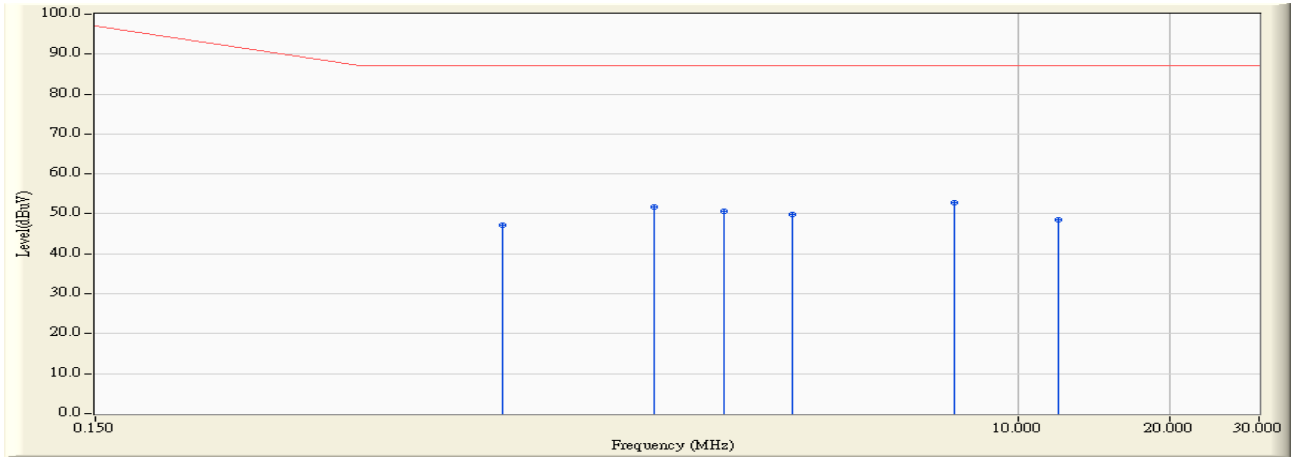

		Frequency (MHz)	Correct Factor (dB)	Reading Level (dBuV)	Measure Level (dBuV)	Margin (dB)	Limit (dBuV)	Detector Type
1		0.959	20.200	26.960	47.160	-39.840	87.000	QUASIPeAK
2		1.916	20.200	31.470	51.670	-35.330	87.000	QUASIPeAK
3		2.634	20.200	30.550	50.750	-36.250	87.000	QUASIPeAK
4		3.580	20.200	29.690	49.890	-37.110	87.000	QUASIPeAK
5	*	7.502	20.200	32.550	52.750	-34.250	87.000	QUASIPeAK
6		12.002	20.277	28.350	48.627	-38.373	87.000	QUASIPeAK

Note:

1. All Reading Levels are Quasi-Peak and average value.
2. " * ", means this data is the worst emission level.
3. Measurement Level = Reading Level + Correct Factor

Site : SR1	Time : 2010/05/20 - 14:59
Limit : ISN_Voltage_A_00M_AV	Margin : 0
EUT : Vandal Dome Network Camera	Probe : CVP-2200A - Line1
Power : By PoE	Note : Mode 3, ISN 10Mbps

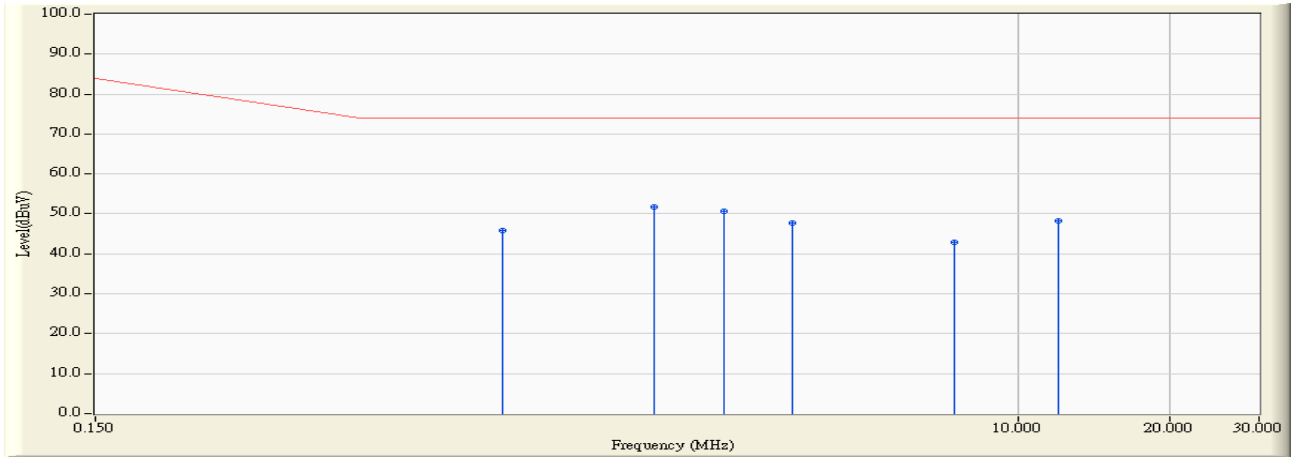

		Frequency (MHz)	Correct Factor (dB)	Reading Level (dBuV)	Measure Level (dBuV)	Margin (dB)	Limit (dBuV)	Detector Type
1		0.959	20.200	25.530	45.730	-28.270	74.000	AVERAGE
2	*	1.916	20.200	31.460	51.660	-22.340	74.000	AVERAGE
3		2.634	20.200	30.540	50.740	-23.260	74.000	AVERAGE
4		3.580	20.200	27.400	47.600	-26.400	74.000	AVERAGE
5		7.502	20.200	22.770	42.970	-31.030	74.000	AVERAGE
6		12.002	20.277	28.100	48.377	-25.623	74.000	AVERAGE

Note:

1. All Reading Levels are Quasi-Peak and average value.
2. " * ", means this data is the worst emission level.
3. Measurement Level = Reading Level + Correct Factor

Site : SR1	Time : 2010/05/20 - 14:57
Limit : ISN_Voltage_A_00M_QP	Margin : 10
EUT : Vandal Dome Network Camera	Probe : CVP-2200A - Line1
Power : By PoE	Note : Mode 3, ISN 100Mbps

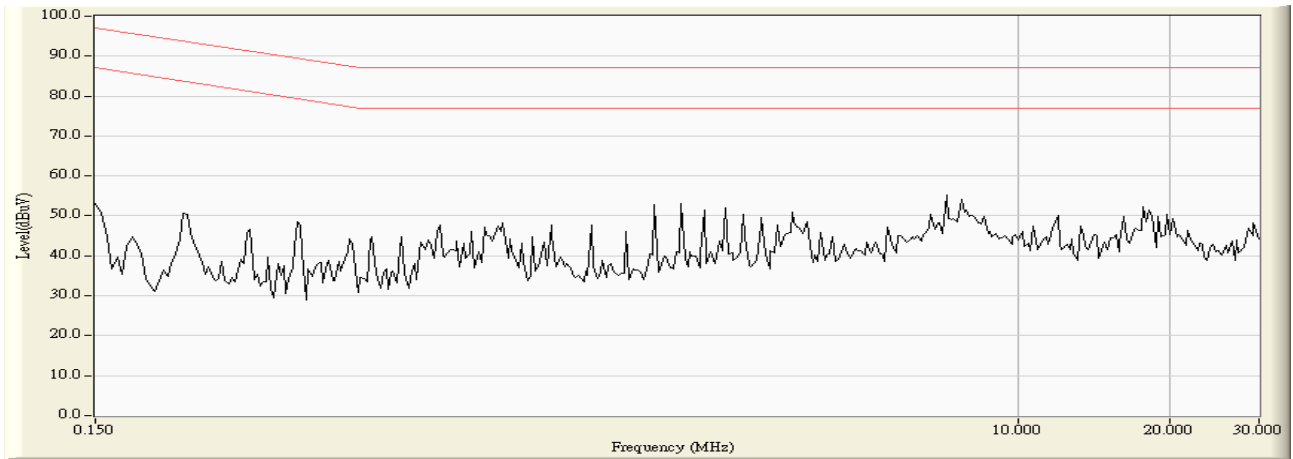

Site : SR1	Time : 2010/05/20 - 14:57
Limit : ISN_Voltage_A_00M_QP	Margin : 0
EUT : Vandal Dome Network Camera	Probe : CVP-2200A - Line1
Power : By PoE	Note : Mode 3, ISN 100Mbps

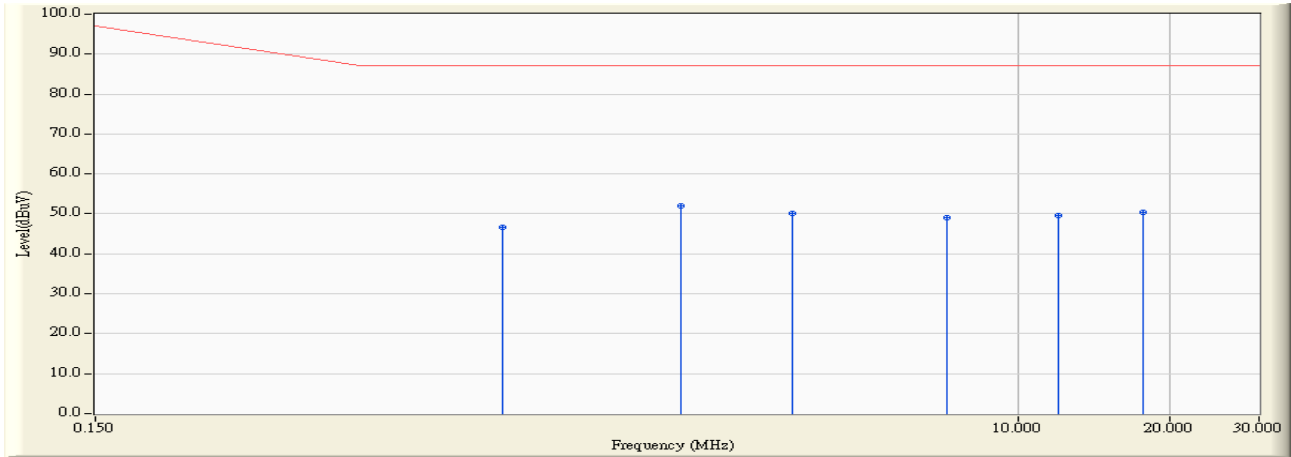

		Frequency (MHz)	Correct Factor (dB)	Reading Level (dBuV)	Measure Level (dBuV)	Margin (dB)	Limit (dBuV)	Detector Type
1		0.959	20.200	26.520	46.720	-40.280	87.000	QUASIPeAK
2	*	2.154	20.200	31.840	52.040	-34.960	87.000	QUASIPeAK
3		3.580	20.200	29.850	50.050	-36.950	87.000	QUASIPeAK
4		7.240	20.200	28.970	49.170	-37.830	87.000	QUASIPeAK
5		12.001	20.277	29.410	49.687	-37.313	87.000	QUASIPeAK
6		17.693	20.400	29.950	50.350	-36.650	87.000	QUASIPeAK

Note:

1. All Reading Levels are Quasi-Peak and average value.
2. " * ", means this data is the worst emission level.
3. Measurement Level = Reading Level + Correct Factor

Site : SR1	Time : 2010/05/20 - 14:57
Limit : ISN_Voltage_A_00M_AV	Margin : 0
EUT : Vandal Dome Network Camera	Probe : CVP-2200A - Line1
Power : By PoE	Note : Mode 3, ISN 100Mbps

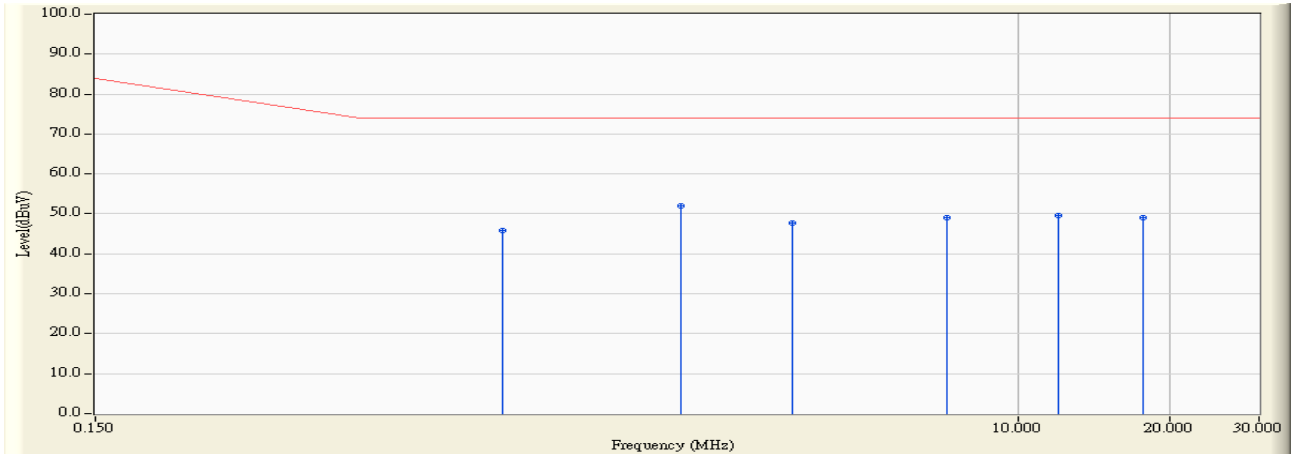

		Frequency (MHz)	Correct Factor (dB)	Reading Level (dBuV)	Measure Level (dBuV)	Margin (dB)	Limit (dBuV)	Detector Type
1		0.959	20.200	25.530	45.730	-28.270	74.000	AVERAGE
2	*	2.154	20.200	31.830	52.030	-21.970	74.000	AVERAGE
3		3.580	20.200	27.590	47.790	-26.210	74.000	AVERAGE
4		7.240	20.200	28.960	49.160	-24.840	74.000	AVERAGE
5		12.001	20.277	29.230	49.507	-24.493	74.000	AVERAGE
6		17.693	20.400	28.620	49.020	-24.980	74.000	AVERAGE

Note:

1. All Reading Levels are Quasi-Peak and average value.
2. " * ", means this data is the worst emission level.
3. Measurement Level = Reading Level + Correct Factor

4.7. Test Photograph

Test Mode : Mode 1: Normal Operation (Adapter: 3A-183WP12)

Description : Front View of ISN Test



Test Mode : Mode 1: Normal Operation (Adapter: 3A-183WP12)

Description : Back View of ISN Test



Test Mode : Mode 2: Normal Operation (AC 24V)

Description : Front View of ISN Test



Test Mode : Mode 2: Normal Operation (AC 24V)

Description : Back View of ISN Test



Test Mode : Mode 3: PoE Mode

Description : Front View of ISN Test



Test Mode : Mode 3: PoE Mode

Description : Back View of ISN Test



5. Radiated Emission

5.1. Test Specification

According to EMC Standard : EN 55022 and AS/NZS CISPR 22

5.2. Test Setup

Under 1GHz Test Setup:

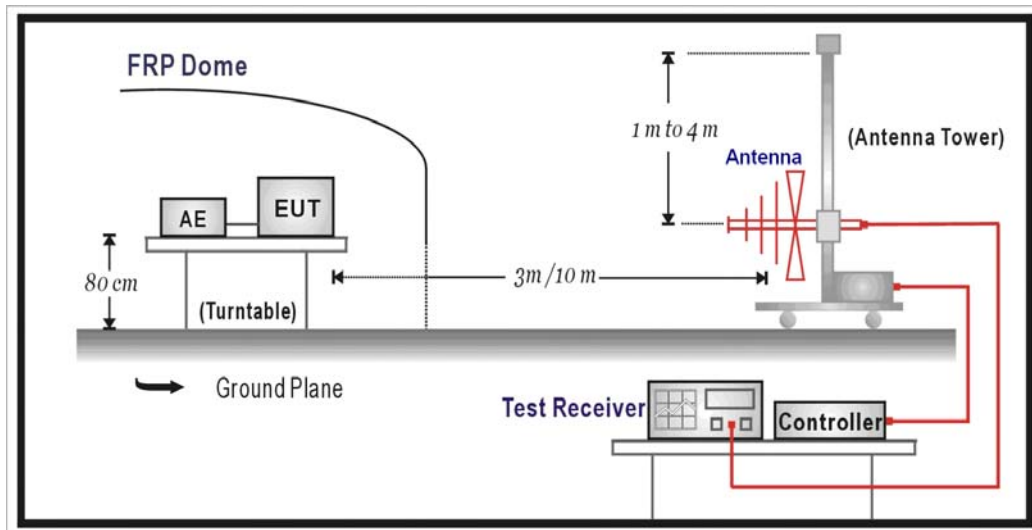

Above 1GHz Test Setup:

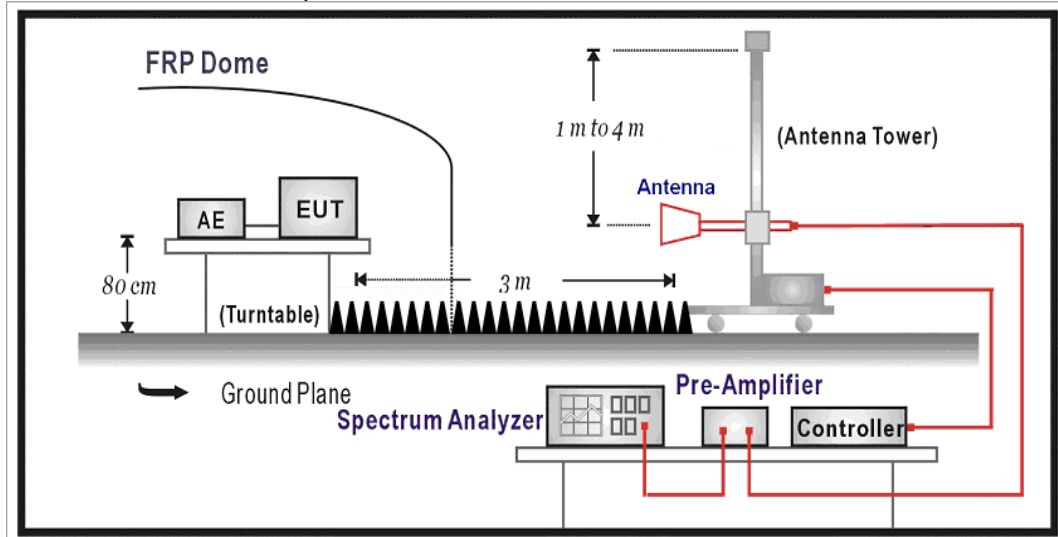

5.3. Limit

Limits		
Frequency MHz	Distance (m)	dBuV/m
30 – 230	10	40
230 – 1000	10	47

Limits			
Frequency (GHz)	Distance (m)	Peak (dBuV/m)	Average (dBuV/m)
1 – 3	3	76	56
3 – 6	3	80	60

Remark:

1. The tighter limit shall apply at the edge between two frequency bands.
2. Distance refers to the distance in meters between the measuring instrument antenna and the closed point of any part of the device or system.

Highest frequency generated or used in the device or on which the device operates or tunes (MHz)	Upper frequency of measurement range (MHz)
Below 108	1000
108 – 500	2000
500 – 1000	5000
Above 1000	5 th harmonic of the highest frequency or 6 GHz, whichever is lower

5.4. Test Procedure

The EUT and its simulators are placed on a turn table which is 0.8 meter above ground. The turn table can rotate 360 degrees to determine the position of the maximum emission level. The EUT was positioned such that the distance from antenna to the EUT was 3/10 meters. The antenna can move up and down between 1 meter and 4 meters to find out the maximum emission level.

Both horizontal and vertical polarization of the antenna are set on measurement. In order to find the maximum emission, all of the interface cables must be manipulated on radiated measurement.

Radiated emissions were investigated over the frequency range from 30MHz to 1GHz using a receiver bandwidth of 120kHz and above 1GHz using a receiver bandwidth of 1MHz.

30MHz to 1GHz Radiated was performed at an antenna to EUT distance of 10 meters.

Above 1GHz Radiated was performed at an antenna to EUT distance of 3 meters.

It is placed with absorb on the ground between EUT and Antenna.

5.5. Deviation from Test Standard

No deviation.

5.6. Test Result

Site : SITE5	Time : 2010/05/18 - 15:35
Limit : CISPR_A_10M_QP	Margin : 6
EUT : Vandal Dome Network Camera	Probe : Site5_CBL6112_10M_0811 - HORIZONTAL
Power : AC 230V/50Hz	Note : Mode 1

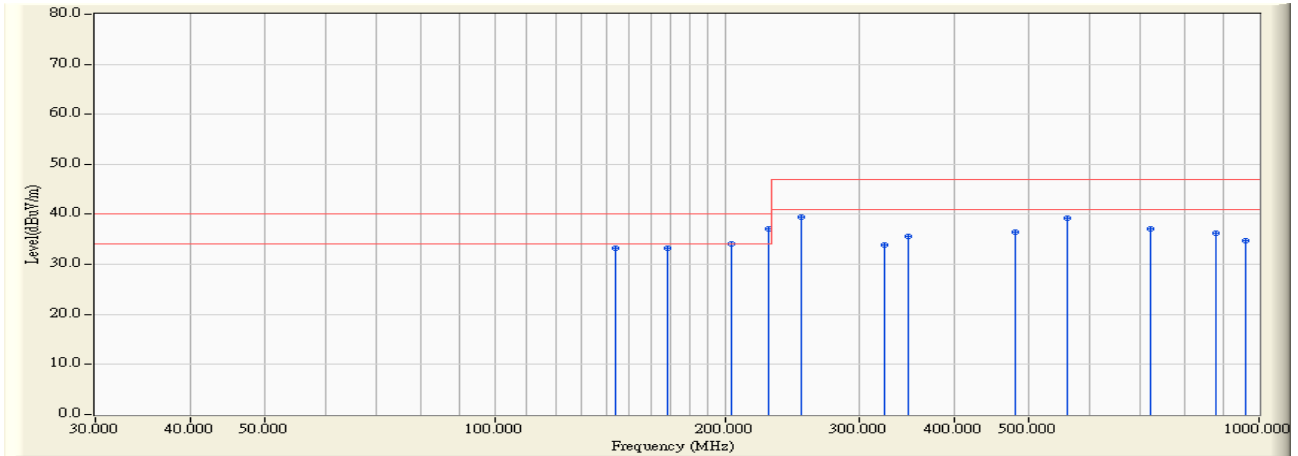

	Frequency (MHz)	Correct Factor (dB)	Reading Level (dBuV)	Measure Level (dBuV/m)	Margin (dB)	Limit (dBuV/m)	Detector Type
1	144.000	13.216	20.100	33.316	-6.684	40.000	QUASIPeAK
2	168.000	12.118	21.200	33.318	-6.682	40.000	QUASIPeAK
3	204.000	11.971	22.100	34.071	-5.929	40.000	QUASIPeAK
4	* 228.000	12.823	24.300	37.123	-2.877	40.000	QUASIPeAK
5	252.000	15.844	23.600	39.444	-7.556	47.000	QUASIPeAK
6	324.000	18.000	15.900	33.900	-13.100	47.000	QUASIPeAK
7	348.002	18.808	16.800	35.608	-11.392	47.000	QUASIPeAK
8	480.005	22.668	13.800	36.468	-10.532	47.000	QUASIPeAK
9	560.010	24.560	14.600	39.160	-7.840	47.000	QUASIPeAK
10	720.011	26.913	10.100	37.013	-9.987	47.000	QUASIPeAK
11	880.012	28.308	7.900	36.208	-10.792	47.000	QUASIPeAK
12	960.016	29.164	5.600	34.764	-12.236	47.000	QUASIPeAK

Note:

1. All Readings below 1GHz are Quasi-Peak, above are performed with peak and/or average measurements as necessary.
2. " * ", means this data is the worst emission level.
3. Measurement Level = Reading Level + Correct Factor

Site : SITE5	Time : 2010/05/18 - 16:06
Limit : CISPR_A_10M_QP	Margin : 6
EUT : Vandal Dome Network Camera	Probe : Site5_CBL6112_10M_0811 - VERTICAL
Power : AC 230V/50Hz	Note : Mode 1

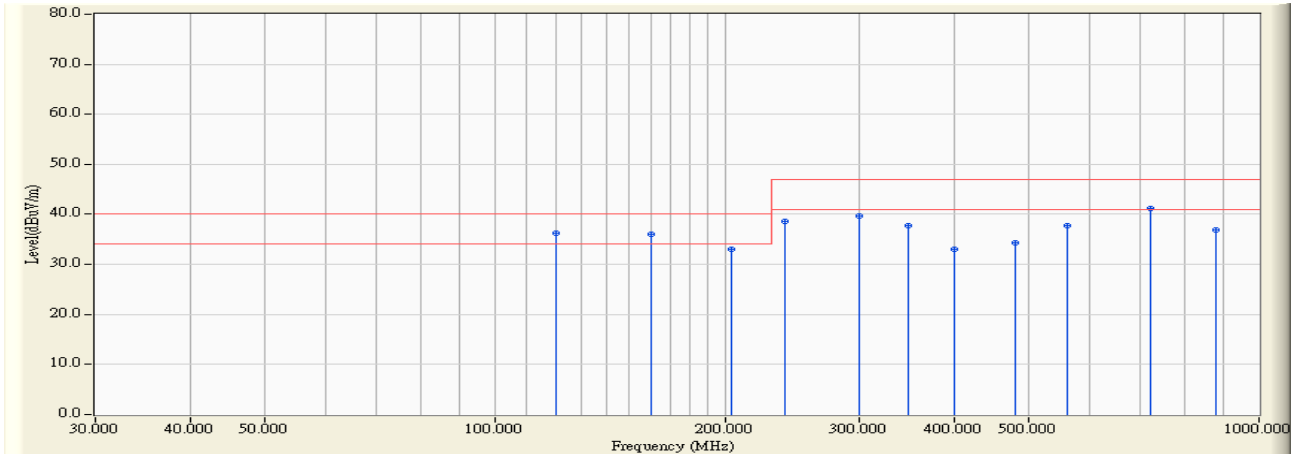

		Frequency (MHz)	Correct Factor (dB)	Reading Level (dBuV)	Measure Level (dBuV/m)	Margin (dB)	Limit (dBuV/m)	Detector Type
1	*	120.000	13.895	22.300	36.195	-3.805	40.000	QUASIPeAK
2		160.000	12.401	23.600	36.001	-3.999	40.000	QUASIPeAK
3		204.000	11.971	21.100	33.071	-6.929	40.000	QUASIPeAK
4		240.003	14.332	24.300	38.632	-8.368	47.000	QUASIPeAK
5		300.000	17.008	22.700	39.707	-7.293	47.000	QUASIPeAK
6		348.002	18.808	18.900	37.708	-9.292	47.000	QUASIPeAK
7		400.000	20.902	12.100	33.002	-13.998	47.000	QUASIPeAK
8		480.005	22.668	11.600	34.268	-12.732	47.000	QUASIPeAK
9		560.010	24.560	13.100	37.660	-9.340	47.000	QUASIPeAK
10		720.011	26.913	14.300	41.213	-5.787	47.000	QUASIPeAK
11		880.015	28.308	8.600	36.908	-10.092	47.000	QUASIPeAK

Note:

1. All Readings below 1GHz are Quasi-Peak, above are performed with peak and/or average measurements as necessary.
2. " * ", means this data is the worst emission level.
3. Measurement Level = Reading Level + Correct Factor

Site : SITE5	Time : 2010/05/18 - 16:48
Limit : CISPR_A_10M_QP	Margin : 6
EUT : Vandal Dome Network Camera	Probe : Site5_CBL6112_10M_0811 - HORIZONTAL
Power : AC 230V/50Hz	Note : Mode 2

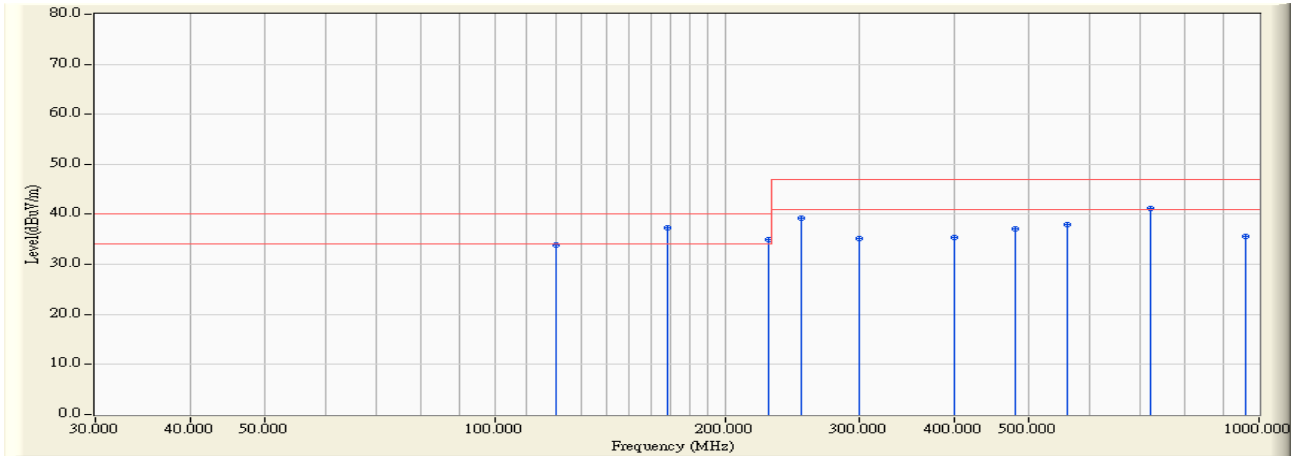

		Frequency (MHz)	Correct Factor (dB)	Reading Level (dBuV)	Measure Level (dBuV/m)	Margin (dB)	Limit (dBuV/m)	Detector Type
1		120.000	13.895	19.900	33.795	-6.205	40.000	QUASIPeAK
2	*	168.000	12.118	25.300	37.418	-2.582	40.000	QUASIPeAK
3		228.000	12.823	22.100	34.923	-5.077	40.000	QUASIPeAK
4		252.000	15.844	23.500	39.344	-7.656	47.000	QUASIPeAK
5		300.000	17.008	18.200	35.207	-11.793	47.000	QUASIPeAK
6		400.000	20.902	14.500	35.402	-11.598	47.000	QUASIPeAK
7		480.001	22.668	14.500	37.168	-9.832	47.000	QUASIPeAK
8		560.007	24.560	13.500	38.060	-8.940	47.000	QUASIPeAK
9		720.012	26.913	14.200	41.113	-5.887	47.000	QUASIPeAK
10		960.015	29.164	6.500	35.664	-11.336	47.000	QUASIPeAK

Note:

1. All Readings below 1GHz are Quasi-Peak, above are performed with peak and/or average measurements as necessary.
2. " * ", means this data is the worst emission level.
3. Measurement Level = Reading Level + Correct Factor

Site : SITE5	Time : 2010/05/18 - 17:14
Limit : CISPR_A_10M_QP	Margin : 6
EUT : Vandal Dome Network Camera	Probe : Site5_CBL6112_10M_0811 - VERTICAL
Power : AC 230V/50Hz	Note : Mode 2

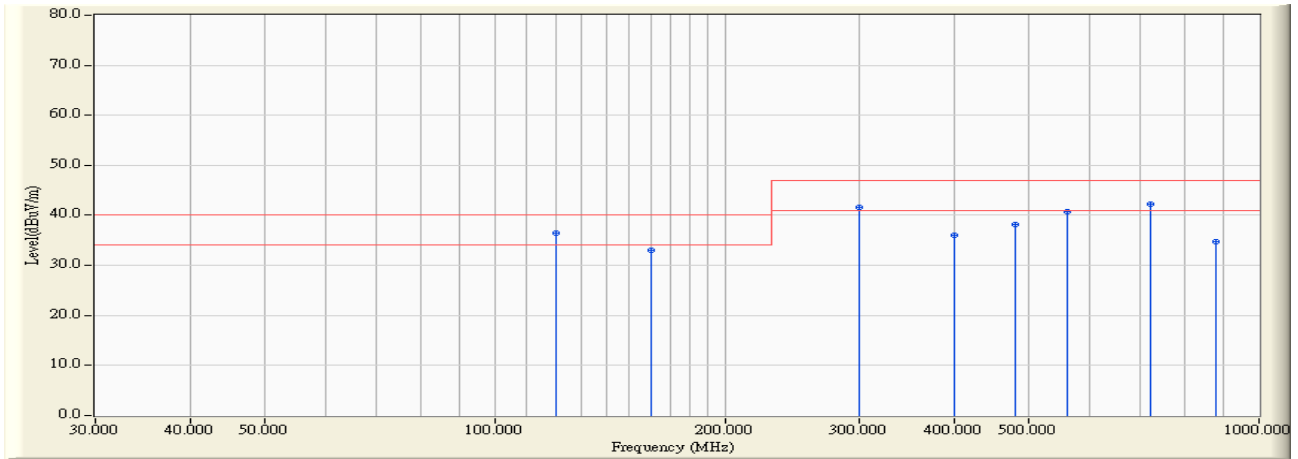

		Frequency (MHz)	Correct Factor (dB)	Reading Level (dBuV)	Measure Level (dBuV/m)	Margin (dB)	Limit (dBuV/m)	Detector Type
1	*	120.000	13.895	22.600	36.495	-3.505	40.000	QUASIPeAK
2		160.000	12.401	20.600	33.001	-6.999	40.000	QUASIPeAK
3		300.000	17.008	24.560	41.567	-5.433	47.000	QUASIPeAK
4		400.003	20.902	15.200	36.102	-10.898	47.000	QUASIPeAK
5		480.006	22.668	15.600	38.268	-8.732	47.000	QUASIPeAK
6		560.000	24.560	16.100	40.660	-6.340	47.000	QUASIPeAK
7		720.011	26.913	15.400	42.313	-4.687	47.000	QUASIPeAK
8		880.000	28.308	6.500	34.808	-12.192	47.000	QUASIPeAK

Note:

1. All Readings below 1GHz are Quasi-Peak, above are performed with peak and/or average measurements as necessary.
2. " * ", means this data is the worst emission level.
3. Measurement Level = Reading Level + Correct Factor

Site : SITE5	Time : 2010/05/18 - 17:37
Limit : CISPR_A_10M_QP	Margin : 6
EUT : Vandal Dome Network Camera	Probe : Site5_CBL6112_10M_0811 - HORIZONTAL
Power : By PoE	Note : Mode 3

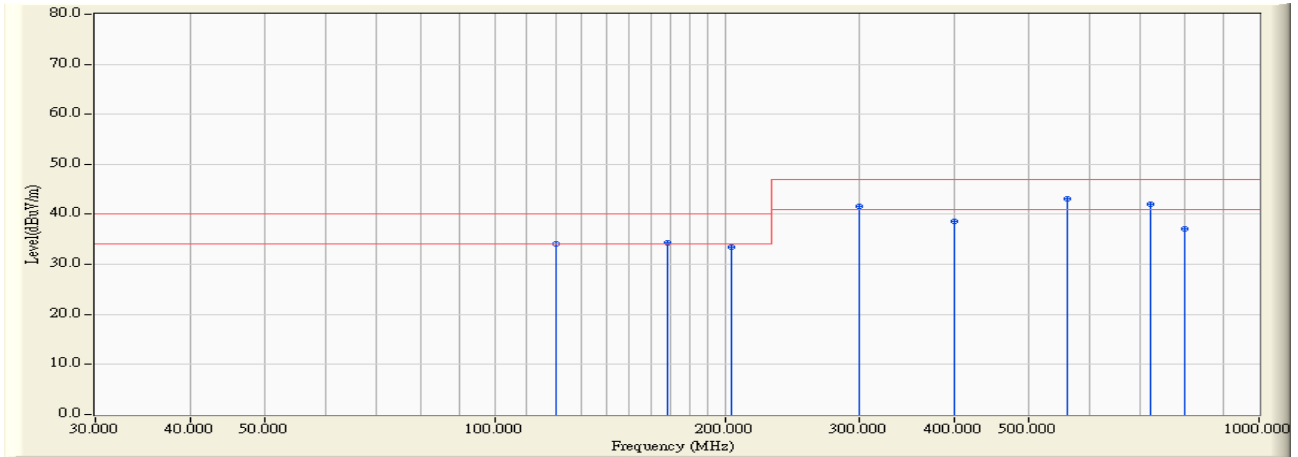

		Frequency (MHz)	Correct Factor (dB)	Reading Level (dBuV)	Measure Level (dBuV/m)	Margin (dB)	Limit (dBuV/m)	Detector Type
1		120.000	13.895	20.100	33.995	-6.005	40.000	QUASPEAK
2		168.000	12.118	22.300	34.418	-5.582	40.000	QUASPEAK
3		204.000	11.971	21.500	33.471	-6.529	40.000	QUASPEAK
4		300.000	17.008	24.700	41.707	-5.293	47.000	QUASPEAK
5		400.000	20.902	17.800	38.702	-8.298	47.000	QUASPEAK
6	*	560.000	24.560	18.600	43.160	-3.840	47.000	QUASPEAK
7		720.010	26.913	15.200	42.113	-4.887	47.000	QUASPEAK
8		800.012	27.499	9.600	37.099	-9.901	47.000	QUASPEAK

Note:

1. All Readings below 1GHz are Quasi-Peak, above are performed with peak and/or average measurements as necessary.
2. " * ", means this data is the worst emission level.
3. Measurement Level = Reading Level + Correct Factor

Site : SITE5	Time : 2010/05/18 - 18:03
Limit : CISPR_A_10M_QP	Margin : 6
EUT : Vandal Dome Network Camera	Probe : Site5_CBL6112_10M_0811 - VERTICAL
Power : By PoE	Note : Mode 3

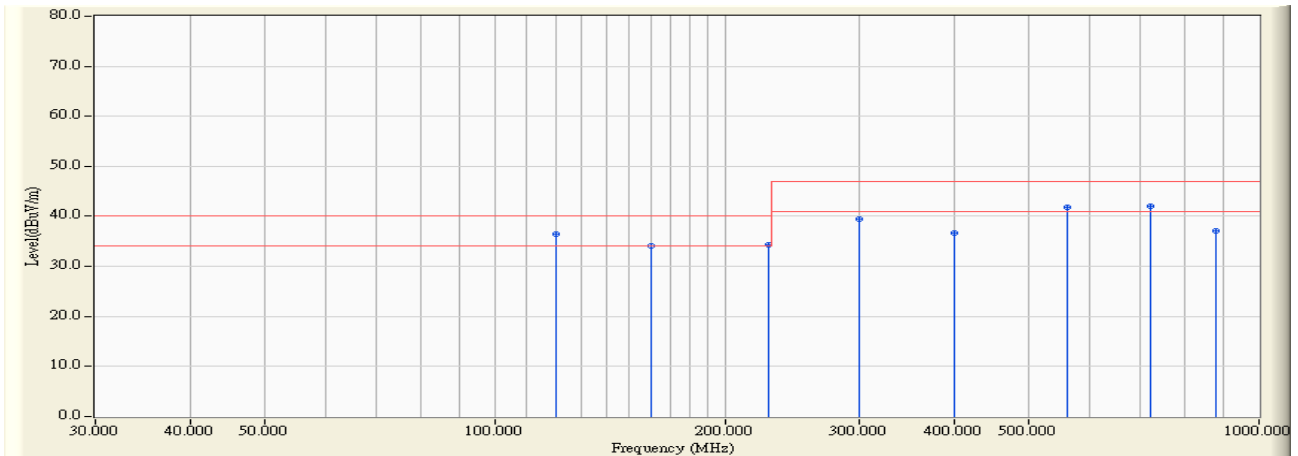

		Frequency (MHz)	Correct Factor (dB)	Reading Level (dBuV)	Measure Level (dBuV/m)	Margin (dB)	Limit (dBuV/m)	Detector Type
1	*	120.000	13.895	22.600	36.495	-3.505	40.000	QUASIPeAK
2		160.000	12.401	21.700	34.101	-5.899	40.000	QUASIPeAK
3		228.000	12.823	21.600	34.423	-5.577	40.000	QUASIPeAK
4		300.000	17.008	22.500	39.507	-7.493	47.000	QUASIPeAK
5		400.003	20.902	15.700	36.602	-10.398	47.000	QUASIPeAK
6		560.000	24.560	17.300	41.860	-5.140	47.000	QUASIPeAK
7		720.011	26.913	15.100	42.013	-4.987	47.000	QUASIPeAK
8		880.016	28.308	8.900	37.208	-9.792	47.000	QUASIPeAK

Note:

1. All Readings below 1GHz are Quasi-Peak, above are performed with peak and/or average measurements as necessary.
2. " * ", means this data is the worst emission level.
3. Measurement Level = Reading Level + Correct Factor

Site: 9x6x6_Chamber	Time: 2010/05/21 - 20:35
Limit: EN55022_B_(Above_1G)	Margin: 0
Probe: 9120D_1-18G_Horn	Polarity: Horizontal
EUT: Vandal Dome Network Camera	Power: AC 230V/50Hz
Note: Mode 1	

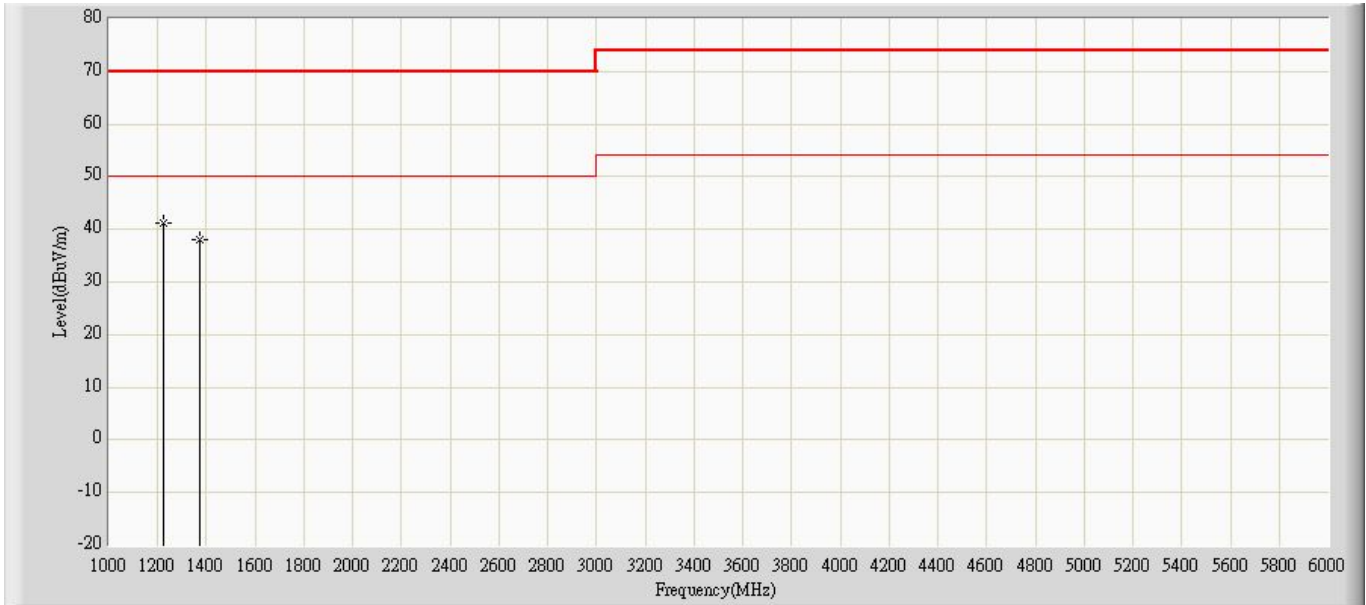

		Frequency (MHz)	Measure Level (dBuV/m)	Reading Level (dBuV)	Over Limit (dB)	Limit (dBuV/m)	Factor	Type
1	*	1220.400	41.267	47.050	-28.733	70.000	-5.783	PK
2		1370.700	38.158	43.380	-31.842	70.000	-5.223	PK

Note:

1. All Readings below 1GHz are Quasi-Peak, above are performed with peak and/or average measurements as necessary.
2. " * ", means this data is the worst emission level.
3. Measurement Level = Reading Level + Factor(Probe+Cable-Amp).

Site: 9x6x6_Chamber	Time: 2010/05/21 - 20:39
Limit: EN55022_B_(Above_1G)	Margin: 0
Probe: 9120D_1-18G_Horn	Polarity: Vertical
EUT: Vandal Dome Network Camera	Power: AC 230V/50Hz
Note: Mode 1	

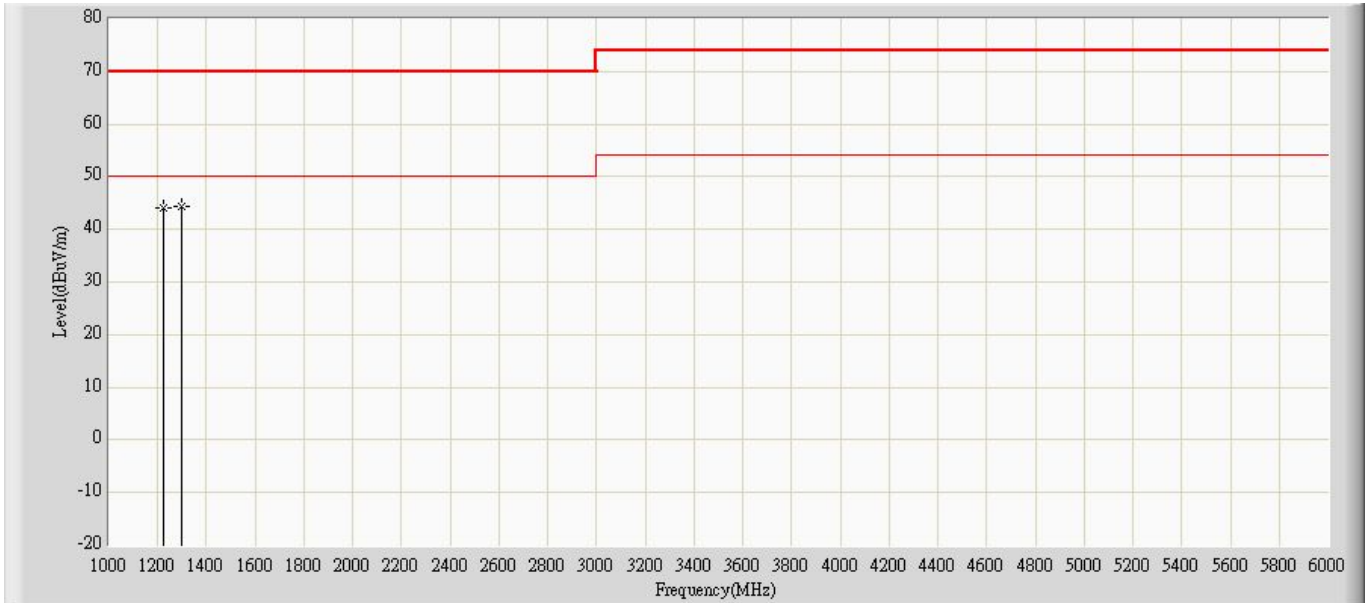

		Frequency (MHz)	Measure Level (dBuV/m)	Reading Level (dBuV)	Over Limit (dB)	Limit (dBuV/m)	Factor	Type
1		1220.440	44.187	49.970	-25.813	70.000	-5.783	PK
2	*	1300.600	44.365	49.850	-25.635	70.000	-5.485	PK

Note:

1. All Readings below 1GHz are Quasi-Peak, above are performed with peak and/or average measurements as necessary.
2. " * ", means this data is the worst emission level.
3. Measurement Level = Reading Level + Factor(Probe+Cable-Amp).

Site: 9x6x6_Chamber	Time: 2010/05/21 - 21:12
Limit: EN55022_B_(Above_1G)	Margin: 0
Probe: 9120D_1-18G_Horn	Polarity: Horizontal
EUT: Vandal Dome Network Camera	Power: AC 230V/50Hz
Note: Mode 2	

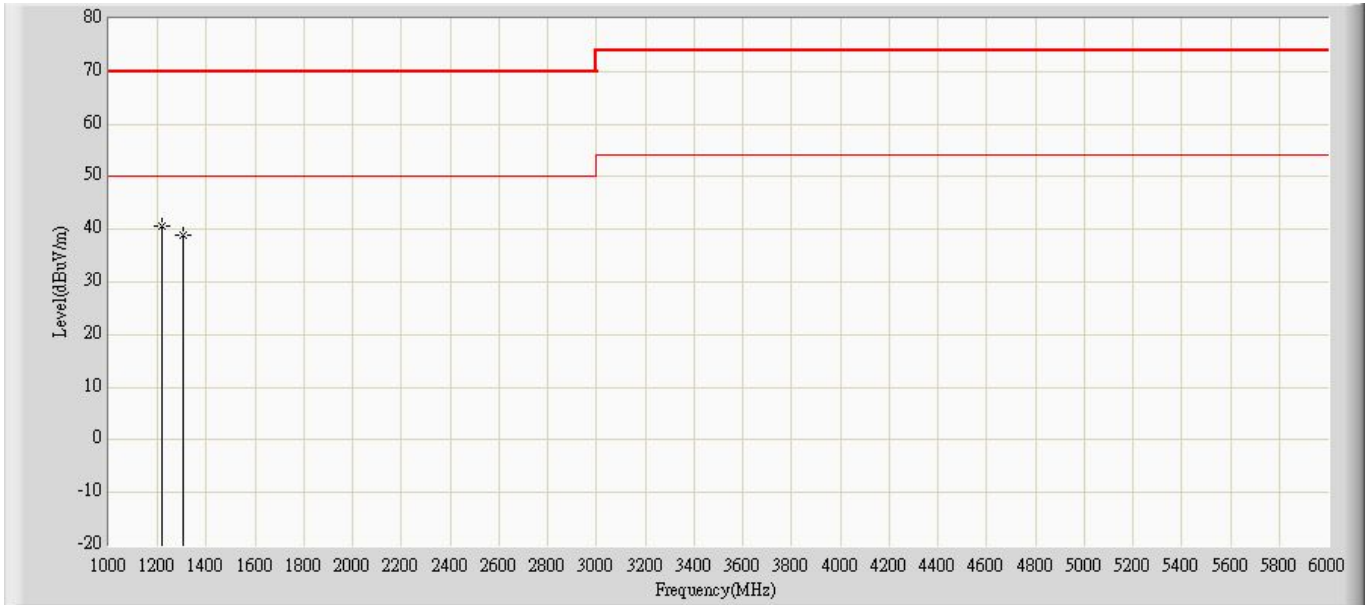

		Frequency (MHz)	Measure Level (dBuV/m)	Reading Level (dBuV)	Over Limit (dB)	Limit (dBuV/m)	Factor	Type
1	*	1220.210	40.606	46.390	-29.394	70.000	-5.783	PK
2		1301.290	38.907	44.390	-31.093	70.000	-5.482	PK

Note:

1. All Readings below 1GHz are Quasi-Peak, above are performed with peak and/or average measurements as necessary.
2. " * ", means this data is the worst emission level.
3. Measurement Level = Reading Level + Factor(Probe+Cable-Amp).

Site: 9x6x6_Chamber	Time: 2010/05/21 - 21:13
Limit: EN55022_B_(Above_1G)	Margin: 0
Probe: 9120D_1-18G_Horn	Polarity: Vertical
EUT: Vandal Dome Network Camera	Power: AC 230V/50Hz
Note: Mode 2	

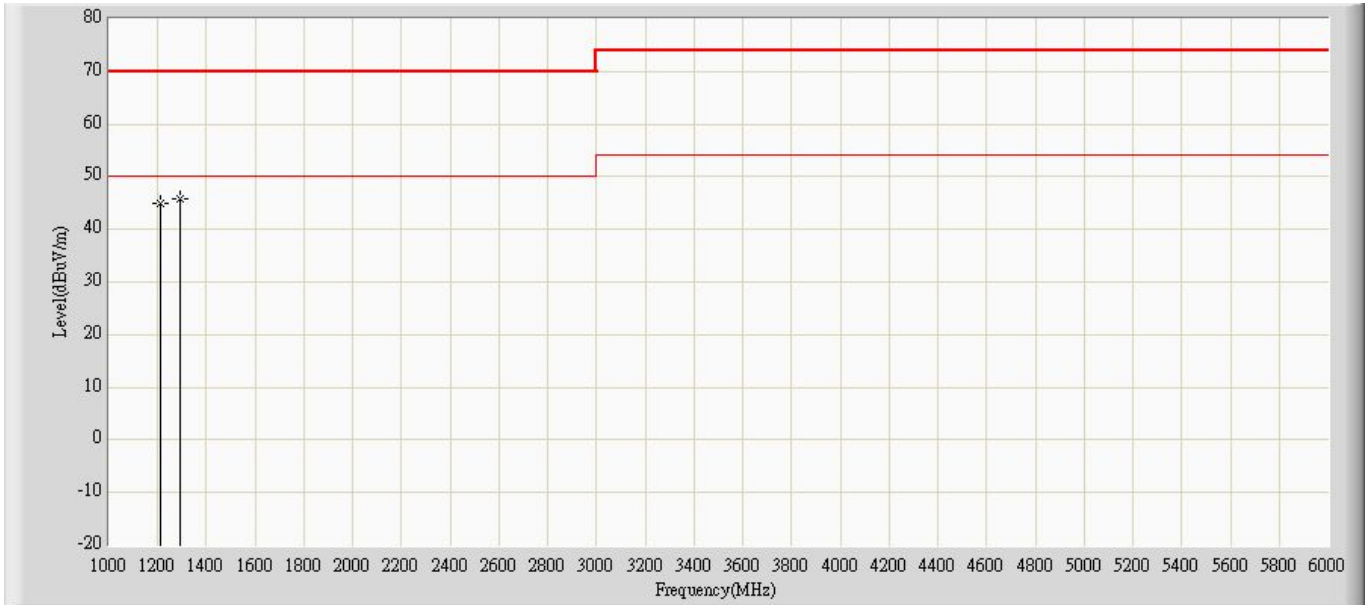

		Frequency (MHz)	Measure Level (dBuV/m)	Reading Level (dBuV)	Over Limit (dB)	Limit (dBuV/m)	Factor	Type
1		1211.740	44.868	50.680	-25.132	70.000	-5.812	PK
2	*	1290.340	45.821	51.340	-24.179	70.000	-5.520	PK

Note:

1. All Readings below 1GHz are Quasi-Peak, above are performed with peak and/or average measurements as necessary.
2. " * ", means this data is the worst emission level.
3. Measurement Level = Reading Level + Factor(Probe+Cable-Amp).

Site: 9x6x6_Chamber	Time: 2010/05/21 - 21:20
Limit: EN55022_B_(Above_1G)	Margin: 0
Probe: 9120D_1-18G_Horn	Polarity: Horizontal
EUT: Vandal Dome Network Camera	Power: By PoE
Note: Mode 3	

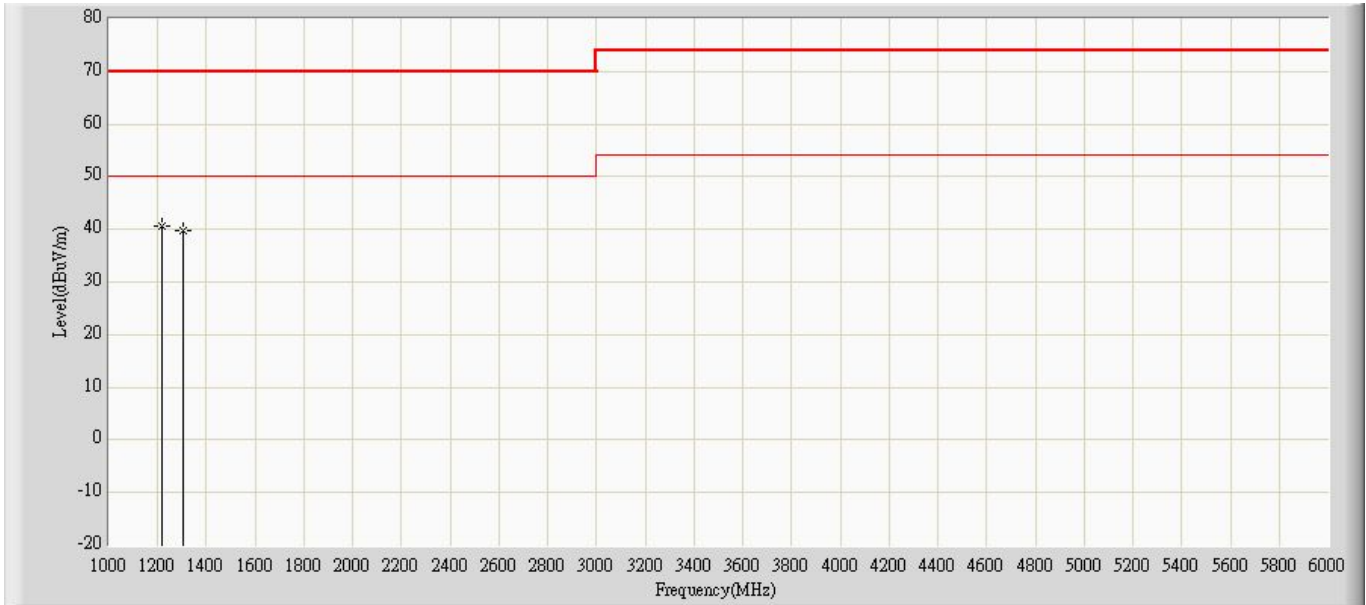

		Frequency (MHz)	Measure Level (dBuV/m)	Reading Level (dBuV)	Over Limit (dB)	Limit (dBuV/m)	Factor	Type
1	*	1220.110	40.726	46.510	-29.274	70.000	-5.784	PK
2		1301.850	39.899	45.380	-30.101	70.000	-5.480	PK

Note:

1. All Readings below 1GHz are Quasi-Peak, above are performed with peak and/or average measurements as necessary.
2. " * ", means this data is the worst emission level.
3. Measurement Level = Reading Level + Factor(Probe+Cable-Amp).

Site: 9x6x6_Chamber	Time: 2010/05/21 - 21:21
Limit: EN55022_B_(Above_1G)	Margin: 0
Probe: 9120D_1-18G_Horn	Polarity: Vertical
EUT: Vandal Dome Network Camera	Power: By PoE
Note: Mode 3	

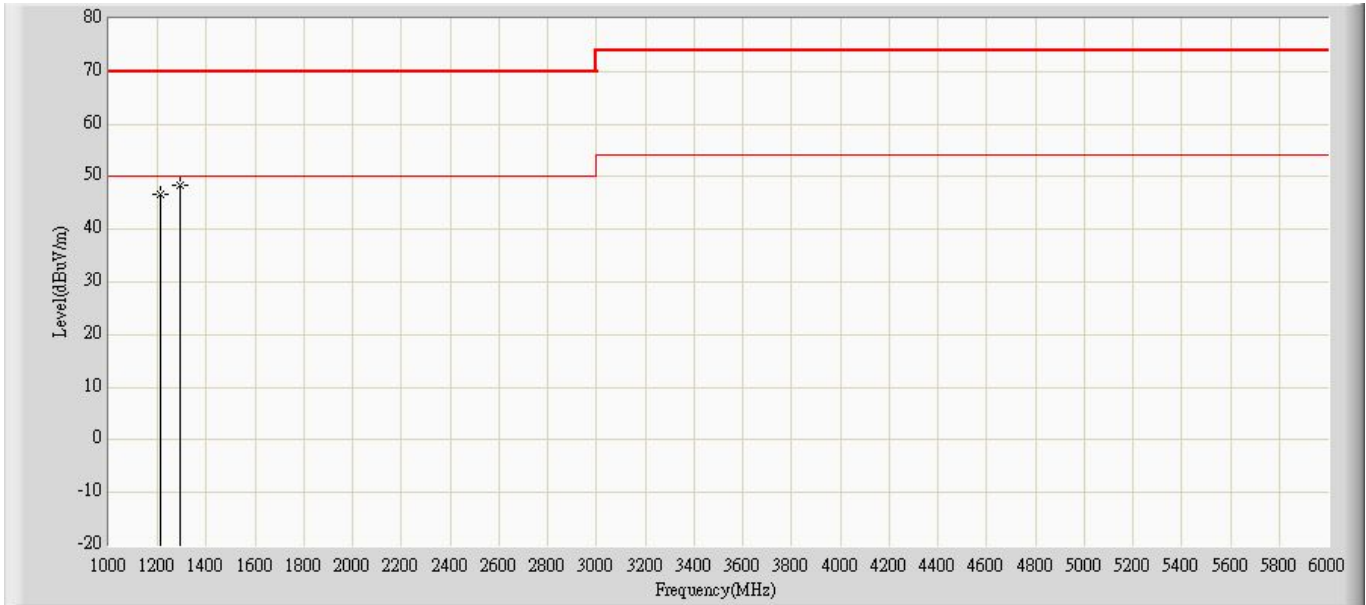

		Frequency (MHz)	Measure Level (dBuV/m)	Reading Level (dBuV)	Over Limit (dB)	Limit (dBuV/m)	Factor	Type
1		1210.350	46.553	52.370	-23.447	70.000	-5.817	PK
2	*	1290.380	48.391	53.910	-21.609	70.000	-5.520	PK

Note:

1. All Readings below 1GHz are Quasi-Peak, above are performed with peak and/or average measurements as necessary.
2. " * ", means this data is the worst emission level.
3. Measurement Level = Reading Level + Factor(Probe+Cable-Amp).

5.7. Test Photograph

Test Mode : Mode 1: Normal Operation (Adapter: 3A-183WP12)

Description : Front View of Radiated Test



Test Mode : Mode 1: Normal Operation (Adapter: 3A-183WP12)

Description : Back View of Radiated Test



Test Mode : Mode 1: Normal Operation (Adapter: 3A-183WP12)

Description : Front View of High Frequency Radiated Test



Test Mode : Mode 2: Normal Operation (AC 24V)

Description : Front View of Radiated Test



Test Mode : Mode 2: Normal Operation (AC 24V)

Description : Back View of Radiated Test



Test Mode : Mode 2: Normal Operation (AC 24V)

Description : Front View of High Frequency Radiated Test



Test Mode : Mode 3: PoE Mode

Description : Front View of Radiated Test



Test Mode : Mode 3: PoE Mode

Description : Back View of Radiated Test



Test Mode : Mode 3: PoE Mode

Description : Front View of High Frequency Radiated Test

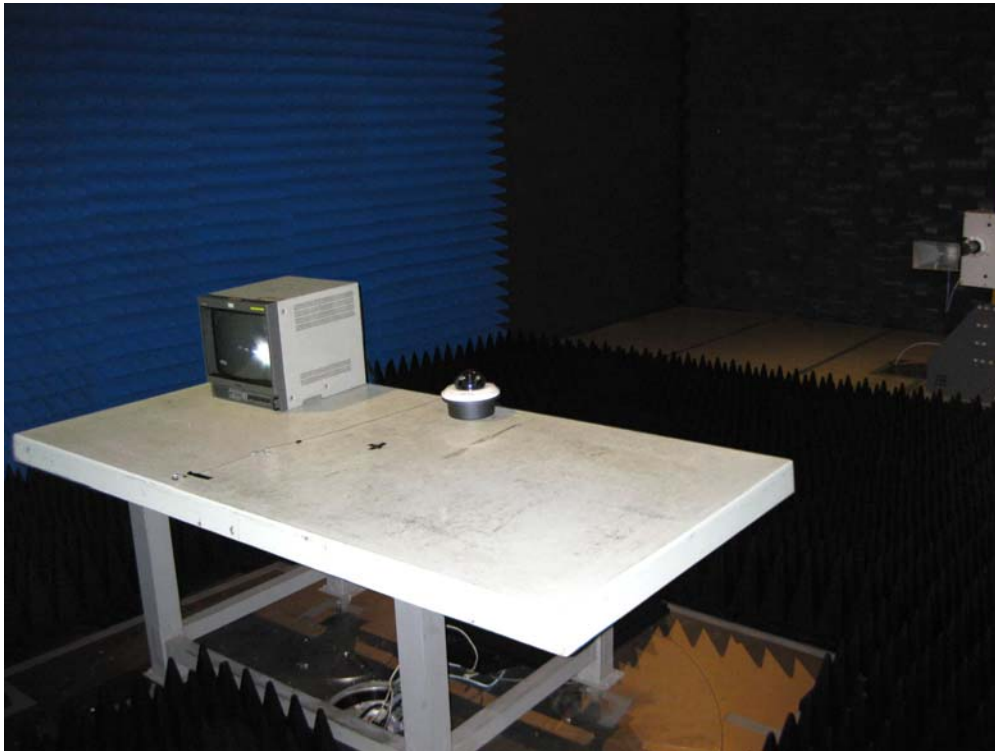

6. Harmonic Current Emission

6.1. Test Specification

According to EMC Standard : EN 61000-3-2

6.2. Test Setup

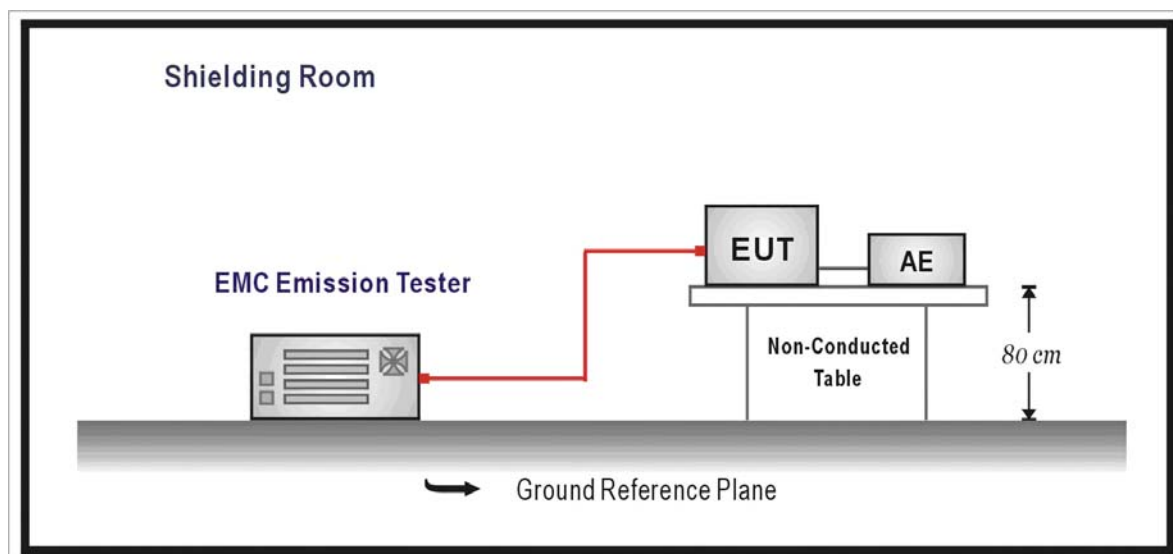

6.3. Limit

(a) Limits of Class A Harmonics Currents

Harmonics Order n	Maximum Permissible harmonic current A	Harmonics Order n	Maximum Permissible harmonic current A
Odd harmonics		Even harmonics	
3	2.30	2	1.08
5	1.14	4	0.43
7	0.77	6	0.30
9	0.40	8 ≤ n ≤ 40	0.23 * 8/n
11	0.33		
13	0.21		
15 ≤ n ≤ 39	0.15 * 15/n		

(b) Limits of Class B Harmonics Currents

For Class B equipment, the harmonic of the input current shall not exceed the maximum permissible values given in table that is the limit of Class A multiplied by a factor of 1.5.

(c) Limits of Class C Harmonics Currents

Harmonics Order n	Maximum Permissible harmonic current Expressed as a percentage of the input current at the fundamental frequency %
2	2
3	$30 \cdot \lambda^*$
5	10
7	7
9	5
$11 \leq n \leq 39$ (odd harmonics only)	3

* λ is the circuit power factor

(d) Limits of Class D Harmonics Currents

Harmonics Order n	Maximum Permissible harmonic current per watt mA/W	Maximum Permissible harmonic current A
3	3.4	2.30
5	1.9	1.14
7	1.0	0.77
9	0.5	0.40
11	0.35	0.33
$11 \leq n \leq 39$ (odd harmonics only)	$3.85/n$	See limit of Class A

6.4. Test Procedure

The EUT is supplied in series with power analyzer from a power source having the same normal voltage and frequency as the rated supply voltage and the equipment under test. And the rated voltage at the supply voltage of EUT of 0.94 times and 1.06 times shall be performed.

6.5. Deviation from Test Standard

No deviation.

6.6. Test Result

Product	Vandal Dome Network Camera		
Test Item	Power Harmonics		
Test Mode	Mode 1: Normal Operation (Adapter: 3A-183WP12)		
Date of Test	2010/05/26	Test Site	No.3 Shielded Room

Test Result: Pass Source qualification: Normal

Current & voltage waveforms

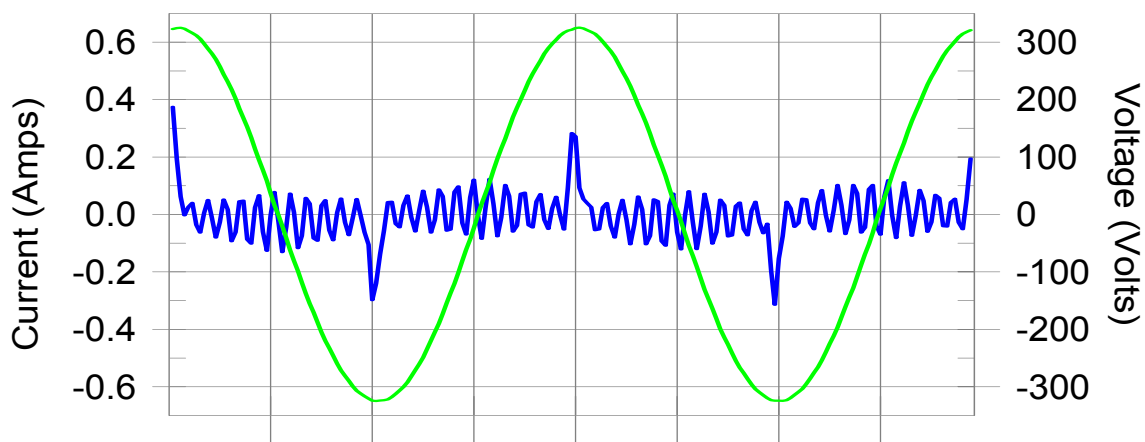

Harmonics and Class A limit line

European Limits

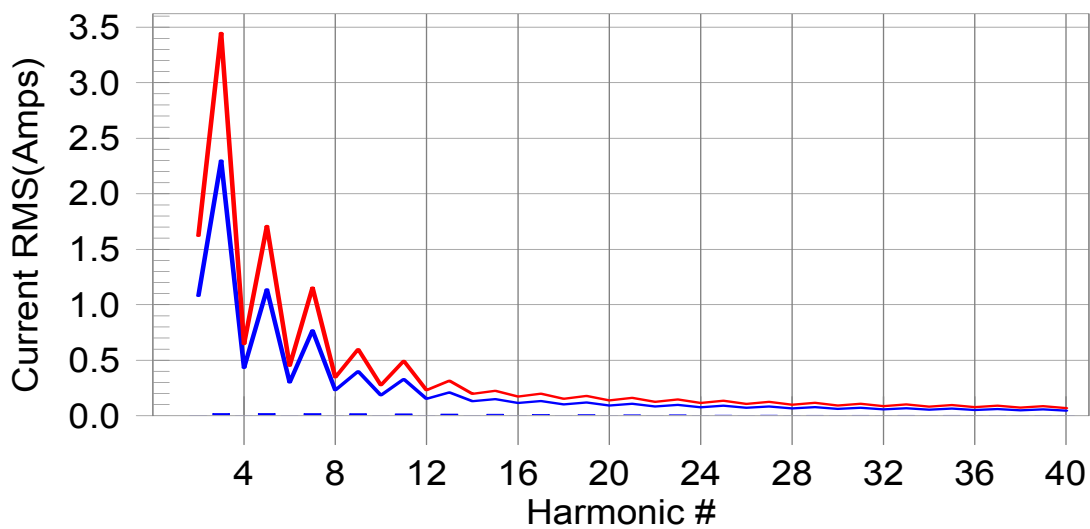

Test result: Pass Worst harmonic was #15 with 8.95% of the limit.

Test Result: Pass Source qualification: Normal
 THC(A): 0.05 I-THD(%): 190.31 POHC(A): 0.016 POHC Limit(A): 0.251
 Highest parameter values during test:

V_RMS (Volts):	229.66	Frequency(Hz):	50.00
I_Peak (Amps):	0.375	I_RMS (Amps):	0.083
I_Fund (Amps):	0.028	Crest Factor:	4.571
Power (Watts):	5.2	Power Factor:	0.273

Harm#	Harms(avg)	100%Limit	%of Limit	Harms(max)	150%Limit	%of Limit	Status
2	0.001	1.080	0.1	0.001	1.620	0.04	Pass
3	0.021	2.300	0.9	0.022	3.450	0.63	Pass
4	0.001	0.430	0.1	0.001	0.645	0.11	Pass
5	0.021	1.140	1.8	0.021	1.710	1.23	Pass
6	0.001	0.300	0.2	0.001	0.450	0.18	Pass
7	0.020	0.770	2.5	0.020	1.155	1.72	Pass
8	0.001	0.230	0.3	0.001	0.345	0.23	Pass
9	0.018	0.400	4.6	0.019	0.600	3.09	Pass
10	0.001	0.184	0.4	0.001	0.276	0.30	Pass
11	0.017	0.330	5.1	0.017	0.495	3.44	Pass
12	0.001	0.153	0.5	0.001	0.230	0.39	Pass
13	0.015	0.210	7.2	0.015	0.315	4.88	Pass
14	0.001	0.131	0.6	0.001	0.197	0.43	Pass
15	0.013	0.150	8.9	0.014	0.225	6.06	Pass
16	0.001	0.115	0.6	0.001	0.173	0.48	Pass
17	0.012	0.132	8.9	0.012	0.199	5.96	Pass
18	0.001	0.102	0.7	0.001	0.153	0.58	Pass
19	0.010	0.118	8.5	0.010	0.178	5.73	Pass
20	0.001	0.092	0.7	0.001	0.138	0.55	Pass
21	0.009	0.107	7.9	0.009	0.161	5.37	Pass
22	0.001	0.084	0.8	0.001	0.125	0.58	Pass
23	0.007	0.098	7.3	0.007	0.147	4.97	Pass
24	0.001	0.077	0.7	0.001	0.115	0.58	Pass
25	0.006	0.090	6.7	0.006	0.135	4.54	Pass
26	0.001	0.071	0.8	0.001	0.106	0.60	Pass
27	0.005	0.083	6.1	0.005	0.125	4.16	Pass
28	0.000	0.066	0.7	0.001	0.099	0.55	Pass
29	0.004	0.078	5.6	0.005	0.116	3.88	Pass
30	0.000	0.061	0.7	0.001	0.092	0.63	Pass
31	0.004	0.073	5.3	0.004	0.109	3.63	Pass
32	0.000	0.058	0.7	0.000	0.086	0.54	Pass
33	0.003	0.068	5.0	0.004	0.102	3.46	Pass
34	0.000	0.054	0.6	0.000	0.081	0.54	Pass
35	0.003	0.064	4.8	0.003	0.096	3.33	Pass
36	0.000	0.051	0.6	0.000	0.077	0.53	Pass
37	0.003	0.061	4.6	0.003	0.091	3.18	Pass
38	0.000	0.048	0.6	0.000	0.073	0.54	Pass
39	0.003	0.058	4.4	0.003	0.087	2.99	Pass
40	0.000	0.046	0.6	0.000	0.069	0.53	Pass

1.Dynamic limits were applied for this test. The highest harmonics values in the above table may not occur at the same window as the maximum harmonics/limit ratio.

2:According to EN61000-3-2 paragraph 7 the note 1 and 2 are valid for all applications having an active input power >75W. Others the result should be pass.

Product	Vandal Dome Network Camera		
Test Item	Power Harmonics		
Test Mode	Mode 2: Normal Operation (AC 24V)		
Date of Test	2010/05/26	Test Site	No.3 Shielded Room

Test Result: Pass Source qualification: Distorted

Current & voltage waveforms

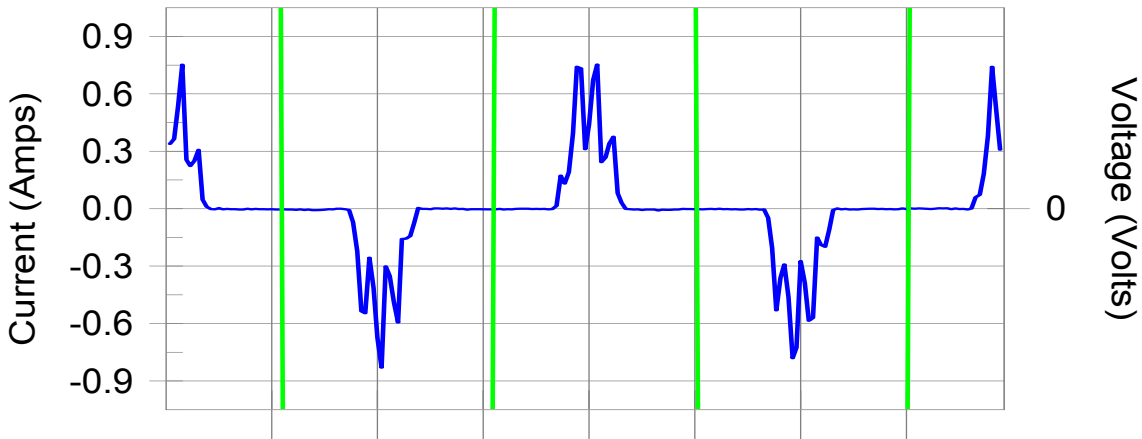

Harmonics and Class A limit line

European Limits

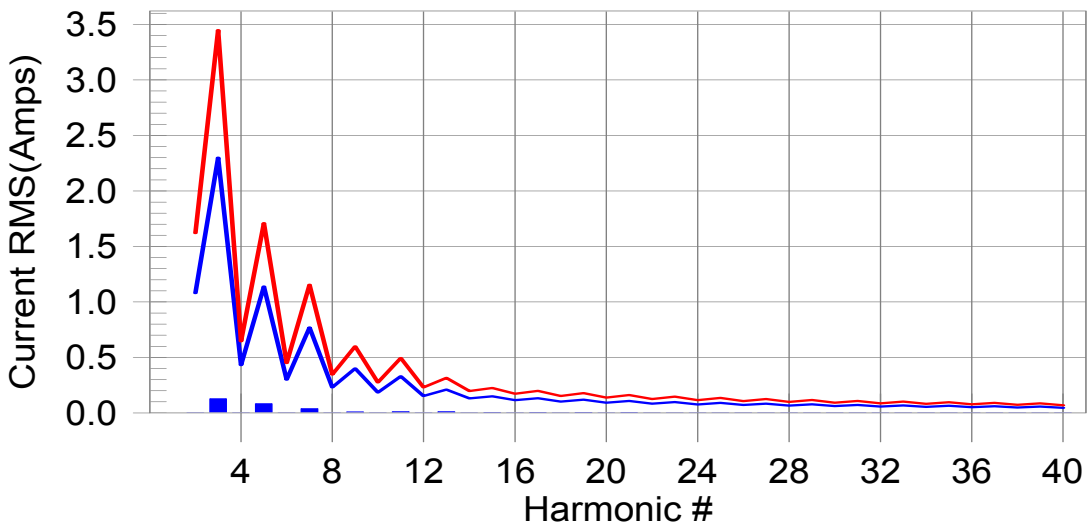

Test result: Pass Worst harmonic was #5 with 7.19% of the limit.

Test Result: Pass Source qualification: Distorted
 THC(A): 0.15 I-THD(%): 102.93 POHC(A): 0.003 POHC Limit(A): 0.251
 Highest parameter values during test:

V_RMS (Volts):	23.98	Frequency(Hz):	50.01
I_Peak (Amps):	0.914	I_RMS (Amps):	0.237
I_Fund (Amps):	0.155	Crest Factor:	3.932
Power (Watts):	3.7	Power Factor:	0.656

Harm#	Harms(avg)	100%Limit	%of Limit	Harms(max)	150%Limit	%of Limit	Status
2	0.001	1.080	0.1	0.001	1.620	0.05	Pass
3	0.124	2.300	5.4	0.128	3.450	3.70	Pass
4	0.001	0.430	0.2	0.001	0.645	0.13	Pass
5	0.082	1.140	7.2	0.084	1.710	4.90	Pass
6	0.001	0.300	0.3	0.001	0.450	0.20	Pass
7	0.039	0.770	5.0	0.039	1.155	3.39	Pass
8	0.001	0.230	0.3	0.001	0.345	0.24	Pass
9	0.009	0.400	2.3	0.010	0.600	1.59	Pass
10	0.001	0.184	0.3	0.001	0.276	0.24	Pass
11	0.010	0.330	3.2	0.011	0.495	2.23	Pass
12	0.000	0.153	0.3	0.001	0.230	0.22	Pass
13	0.010	0.210	4.9	0.010	0.315	3.32	Pass
14	0.000	0.131	0.2	0.000	0.197	0.15	Pass
15	0.004	0.150	2.8	0.004	0.225	1.92	Pass
16	0.000	0.115	0.2	0.000	0.173	0.17	Pass
17	0.002	0.132	1.8	0.003	0.199	1.36	Pass
18	0.000	0.102	0.3	0.000	0.153	0.27	Pass
19	0.004	0.118	3.2	0.004	0.178	2.24	Pass
20	0.000	0.092	0.5	0.001	0.138	0.39	Pass
21	0.002	0.107	2.0	0.002	0.161	1.41	Pass
22	0.001	0.084	0.6	0.001	0.125	0.48	Pass
23	0.001	0.098	0.8	0.001	0.147	0.60	Pass
24	0.000	0.077	0.6	0.001	0.115	0.45	Pass
25	0.002	0.090	1.9	0.002	0.135	1.38	Pass
26	0.000	0.071	0.6	0.000	0.106	0.46	Pass
27	0.001	0.083	1.5	0.001	0.125	1.09	Pass
28	0.001	0.066	0.9	0.001	0.099	0.67	Pass
29	0.000	0.078	0.3	0.000	0.116	0.28	Pass
30	0.001	0.061	1.1	0.001	0.092	0.80	Pass
31	0.001	0.073	1.1	0.001	0.109	0.86	Pass
32	0.001	0.058	0.9	0.001	0.086	0.69	Pass
33	0.001	0.068	1.1	0.001	0.102	0.78	Pass
34	0.000	0.054	0.5	0.000	0.081	0.43	Pass
35	0.000	0.064	0.2	0.000	0.096	0.20	Pass
36	0.000	0.051	0.6	0.000	0.077	0.49	Pass
37	0.000	0.061	0.7	0.001	0.091	0.55	Pass
38	0.000	0.048	0.9	0.000	0.073	0.68	Pass
39	0.000	0.058	0.8	0.001	0.087	0.61	Pass
40	0.000	0.046	0.9	0.000	0.069	0.68	Pass

1.Dynamic limits were applied for this test. The highest harmonics values in the above table may not occur at the same window as the maximum harmonics/limit ratio.

2:According to EN61000-3-2 paragraph 7 the note 1 and 2 are valid for all applications having an active input power >75W. Others the result should be pass.

6.7. Test Photograph

Test Mode : Mode 1: Normal Operation (Adapter: 3A-183WP12)

Description : Power Harmonics Test Setup



Test Mode : Mode 2: Normal Operation (AC 24V)

Description : Power Harmonics Test Setup



7. Voltage Fluctuation and Flicker

7.1. Test Specification

According to EMC Standard : EN 61000-3-3

7.2. Test Setup

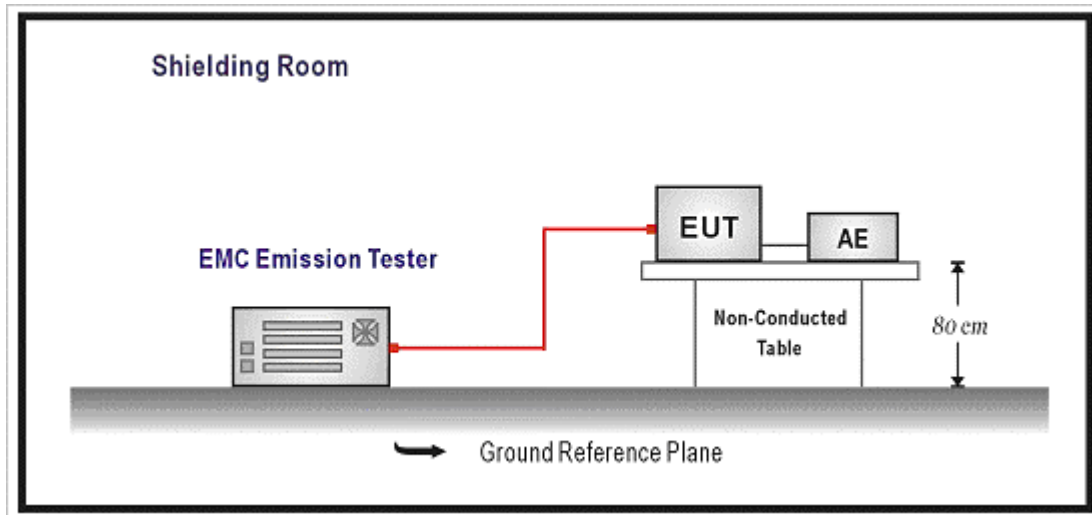

7.3. Limit

The following limits apply:

- the value of P_{st} shall not be greater than 1.0;
- the value of P_{1t} shall not be greater than 0.65;
- the value of $d(t)$ during a voltage change shall not exceed 3.3 % for more than 500 ms;
- the relative steady-state voltage change, d_c , shall not exceed 3.3 %;
- the maximum relative voltage change, d_{max} , shall not exceed;
 - a) 4 % without additional conditions;
 - b) 6 % for equipment which is:
 - switched manually, or
 - switched automatically more frequently than twice per day, and also has either a delayed restart (the delay being not less than a few tens of seconds), or manual restart, after a power supply interruption.

NOTE The cycling frequency will be further limited by the P_{st} and P_{1t} limit.

For example: a d_{max} of 6% producing a rectangular voltage change characteristic twice per hour will give a P_{1t} of about 0.65.

- c) 7 % for equipment which is:
- attended whilst in use (for example: hair dryers, vacuum cleaners, kitchen equipment such as mixers, garden equipment such as lawn mowers, portable tools such as electric drills), or
 - switched on automatically, or is intended to be switched on manually, no more than twice per day, and also has either a delayed restart (the delay being not less than a few tens of seconds) or manual restart, after a power supply interruption.

P_{st} and P_{1t} requirements shall not be applied to voltage changes caused by manual switching.

7.4. Test Procedure

The EUT is supplied in series with power analyzer from a power source having the same normal voltage and frequency as the rated supply voltage and the equipment under test. And the rated voltage at the supply voltage of EUT of 0.94 times and 1.06 times shall be performed.

7.5. Deviation from Test Standard

No deviation.

7.6. Test Result

Product	Vandal Dome Network Camera		
Test Item	Voltage Fluctuation and Flicker		
Test Mode	Mode 1: Normal Operation (Adapter: 3A-183WP12)		
Date of Test	2010/05/26	Test Site	No.3 Shielded Room

Test Result: Pass Status: Test Completed

Pst_i and limit line

European Limits

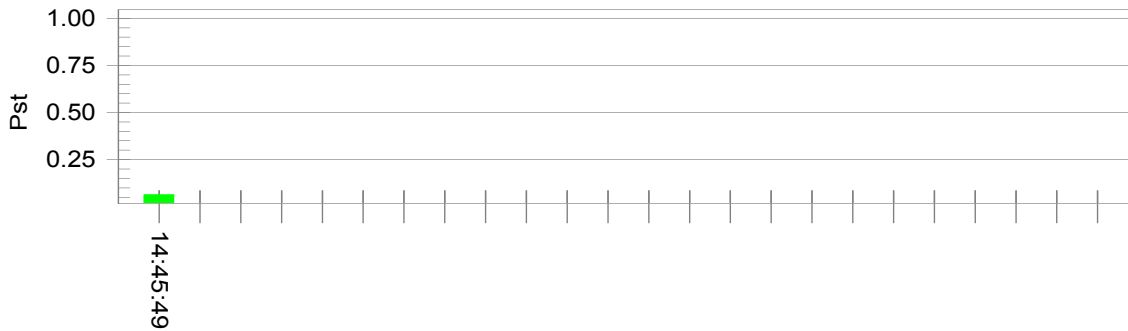

Plt and limit line

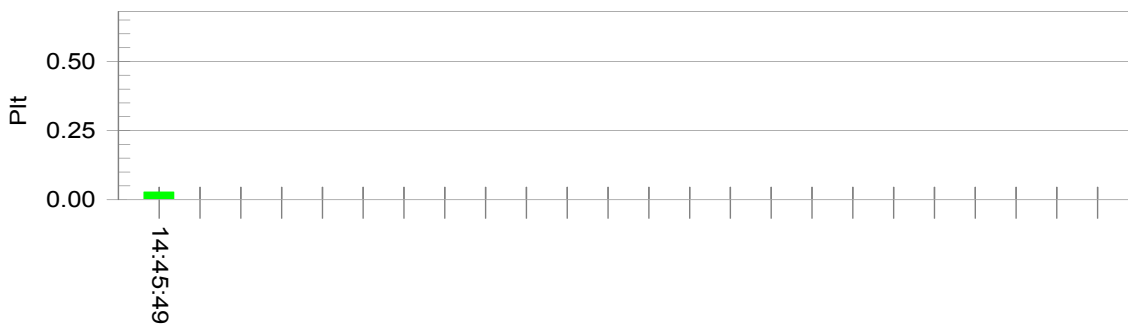

Parameter values recorded during the test:

Vrms at the end of test (Volt):	229.58		
Highest dt (%):	0.00	Test limit (%):	3.30 Pass
Time(mS) > dt:	0.0	Test limit (mS):	500.0 Pass
Highest dc (%):	0.00	Test limit (%):	3.30 Pass
Highest dmax (%):	0.00	Test limit (%):	4.00 Pass
Highest Pst (10 min. period):	0.064	Test limit:	1.000 Pass
Highest Plt (2 hr. period):	0.028	Test limit:	0.650 Pass

Product	Vandal Dome Network Camera		
Test Item	Voltage Fluctuation and Flicker		
Test Mode	Mode 2: Normal Operation (AC 24V)		
Date of Test	2010/05/26	Test Site	No.3 Shielded Room

Test Result: Pass Status: Test Completed

Pstj and limit line

European Limits



Plt and limit line

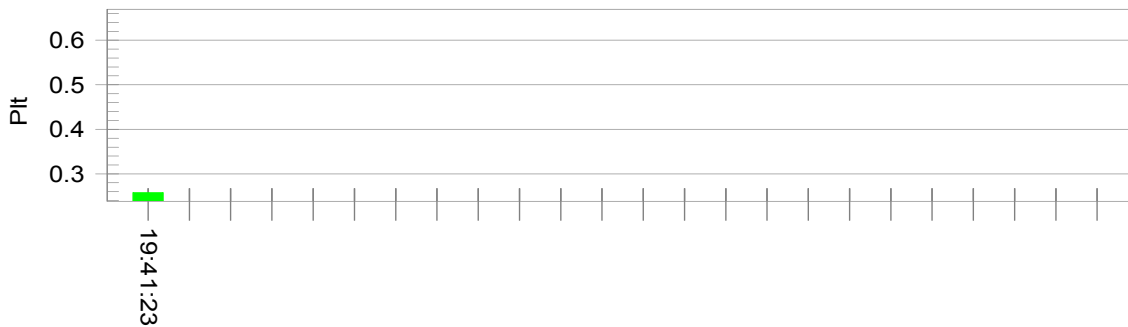

Parameter values recorded during the test:

Vrms at the end of test (Volt):	23.85		
Highest dt (%):	-0.46	Test limit (%):	3.30 Pass
Time(mS) > dt:	0.0	Test limit (mS):	500.0 Pass
Highest dc (%):	0.00	Test limit (%):	3.30 Pass
Highest dmax (%):	0.43	Test limit (%):	4.00 Pass
Highest Pst (10 min. period):	0.591	Test limit:	1.000 Pass
Highest Plt (2 hr. period):	0.258	Test limit:	0.650 Pass

7.7. Test Photograph

Test Mode : Mode 1: Normal Operation (Adapter: 3A-183WP12)

Description : Flicker Test Setup



Test Mode : Mode 2: Normal Operation (AC 24V)

Description : Flicker Test Setup



8. Electrostatic Discharge

8.1. Test Specification

According to Standard : IEC 61000-4-2

8.2. Test Setup

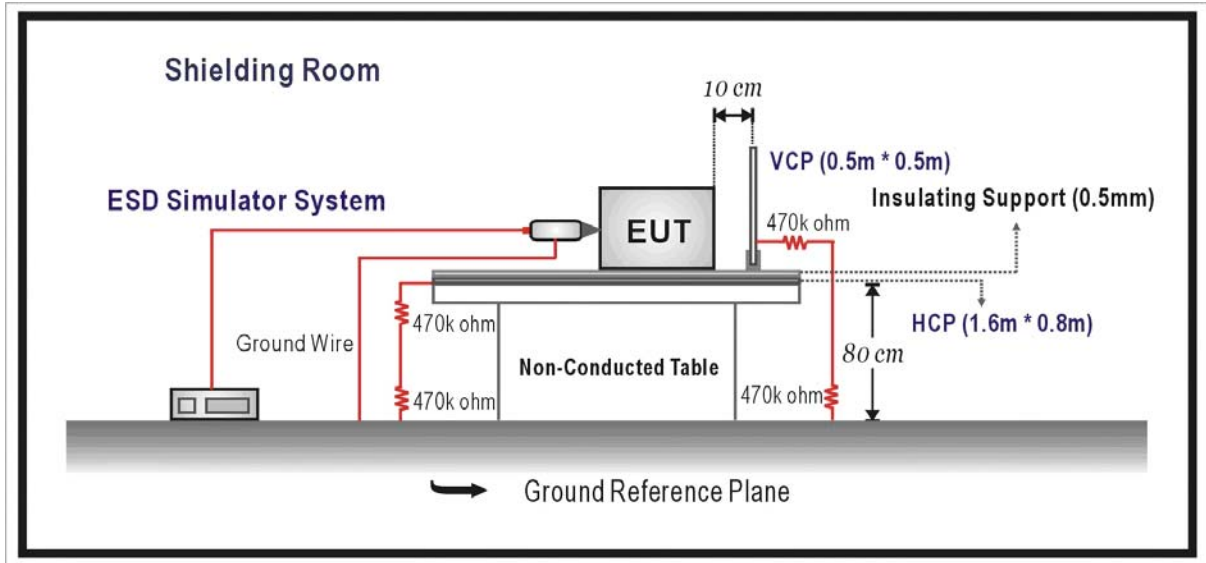

8.3. Limit

Item	Environmental Phenomena	Units	Test Specification	Performance Criteria
Enclosure Port				
	Electrostatic Discharge	kV(Charge Voltage)	±8 Air Discharge ±4 Contact Discharge	B

8.4. Test Procedure

Direct application of discharges to the EUT:

Contact discharge was applied only to conductive surfaces of the EUT.

Air discharges were applied only to non-conductive surfaces of the EUT.

During the test, it was performed with single discharges. For the single discharge time between successive single discharges will be keep longer 1 second. It was at least ten single discharges with positive and negative at the same selected point.

The selected point, which was performed with electrostatic discharge, was marked on the red label of the EUT.

Indirect application of discharges to the EUT:

Vertical Coupling Plane (VCP):

The coupling plane, of dimensions 0.5m x 0.5m, is placed parallel to, and positioned at a distance 0.1m from, the EUT, with the Discharge Electrode touching the coupling plane.

The four faces of the EUT will be performed with electrostatic discharge. It was at least ten single discharges with positive and negative at the same selected point.

Horizontal Coupling Plane (HCP):

The coupling plane is placed under to the EUT. The generator shall be positioned vertically at a distance of 0.1m from the EUT, with the Discharge Electrode touching the coupling plane.

The four faces of the EUT will be performed with electrostatic discharge. It was at least ten single discharges with positive and negative at the same selected point.

8.5. Deviation from Test Standard

No deviation.

8.6. Test Result

Product	Vandal Dome Network Camera		
Test Item	Electrostatic Discharge		
Test Mode	Mode 1: Normal Operation (Adapter: 3A-183WP12)		
Date of Test	2010/05/27	Test Site	No.3 Shielded Room

Item	Amount of Discharge	Voltage	Required Criteria	Complied To Criteria (A,B,C)	Results
Air Discharge	10	+8kV	B	B	Pass
	10	-8kV	B	B	Pass
Contact Discharge	25	+4kV	B	A	Pass
	25	-4kV	B	A	Pass
Indirect Discharge (HCP)	25	+4kV	B	A	Pass
	25	-4kV	B	A	Pass
Indirect Discharge (VCP Front)	25	+4kV	B	A	Pass
	25	-4kV	B	A	Pass
Indirect Discharge (VCP Left)	25	+4kV	B	A	Pass
	25	-4kV	B	A	Pass
Indirect Discharge (VCP Back)	25	+4kV	B	A	Pass
	25	-4kV	B	A	Pass
Indirect Discharge (VCP Right)	25	+4kV	B	A	Pass
	25	-4kV	B	A	Pass

Note:

The testing performed is from lowest level up to the highest level as required by standard, but only highest level is shown on the report.

NR: No Requirement

- Meet criteria A: Operate as intended during and after the test
- Meet criteria B: Operate as intended after the test
- Meet criteria C: Loss/Error of function
- Additional Information
 - EUT stopped operation and could / could not be reset by operator at ____ kV.
 - No false alarms or other malfunctions were observed during or after the test.

Remark:

The Contact discharges were applied at least total 200 discharges at a minimum of four test points.

Product	Vandal Dome Network Camera		
Test Item	Electrostatic Discharge		
Test Mode	Mode 2: Normal Operation (AC 24V)		
Date of Test	2010/05/27	Test Site	No.3 Shielded Room

Item	Amount of Discharge	Voltage	Required Criteria	Complied To Criteria (A,B,C)	Results
Air Discharge	10	+8kV	B	B	Pass
	10	-8kV	B	B	Pass
Contact Discharge	25	+4kV	B	A	Pass
	25	-4kV	B	A	Pass
Indirect Discharge (HCP)	25	+4kV	B	A	Pass
	25	-4kV	B	A	Pass
Indirect Discharge (VCP Front)	25	+4kV	B	A	Pass
	25	-4kV	B	A	Pass
Indirect Discharge (VCP Left)	25	+4kV	B	A	Pass
	25	-4kV	B	A	Pass
Indirect Discharge (VCP Back)	25	+4kV	B	A	Pass
	25	-4kV	B	A	Pass
Indirect Discharge (VCP Right)	25	+4kV	B	A	Pass
	25	-4kV	B	A	Pass

Note:

The testing performed is from lowest level up to the highest level as required by standard, but only highest level is shown on the report.

NR: No Requirement

- Meet criteria A: Operate as intended during and after the test
- Meet criteria B: Operate as intended after the test
- Meet criteria C: Loss/Error of function
- Additional Information
 - EUT stopped operation and could / could not be reset by operator at ____ kV.
 - No false alarms or other malfunctions were observed during or after the test.

Remark:

The Contact discharges were applied at least total 200 discharges at a minimum of four test points.

Product	Vandal Dome Network Camera		
Test Item	Electrostatic Discharge		
Test Mode	Mode 3: PoE Mode		
Date of Test	2010/05/27	Test Site	No.3 Shielded Room

Item	Amount of Discharge	Voltage	Required Criteria	Complied To Criteria (A,B,C)	Results
Air Discharge	10	+8kV	B	B	Pass
	10	-8kV	B	B	Pass
Contact Discharge	25	+4kV	B	A	Pass
	25	-4kV	B	A	Pass
Indirect Discharge (HCP)	25	+4kV	B	A	Pass
	25	-4kV	B	A	Pass
Indirect Discharge (VCP Front)	25	+4kV	B	A	Pass
	25	-4kV	B	A	Pass
Indirect Discharge (VCP Left)	25	+4kV	B	A	Pass
	25	-4kV	B	A	Pass
Indirect Discharge (VCP Back)	25	+4kV	B	A	Pass
	25	-4kV	B	A	Pass
Indirect Discharge (VCP Right)	25	+4kV	B	A	Pass
	25	-4kV	B	A	Pass

Note:

The testing performed is from lowest level up to the highest level as required by standard, but only highest level is shown on the report.

NR: No Requirement

- Meet criteria A: Operate as intended during and after the test
- Meet criteria B: Operate as intended after the test
- Meet criteria C: Loss/Error of function
- Additional Information
 - EUT stopped operation and could / could not be reset by operator at ____ kV.
 - No false alarms or other malfunctions were observed during or after the test.

Remark:

The Contact discharges were applied at least total 200 discharges at a minimum of four test points.

8.7. Test Photograph

Test Mode : Mode 1: Normal Operation (Adapter: 3A-183WP12)

Description : ESD Test Setup



Test Mode : Mode 2: Normal Operation (AC 24V)

Description : ESD Test Setup



Test Mode : Mode 3: PoE Mode

Description : ESD Test Setup



9. Radiated Susceptibility

9.1. Test Specification

According to Standard : IEC 61000-4-3

9.2. Test Setup

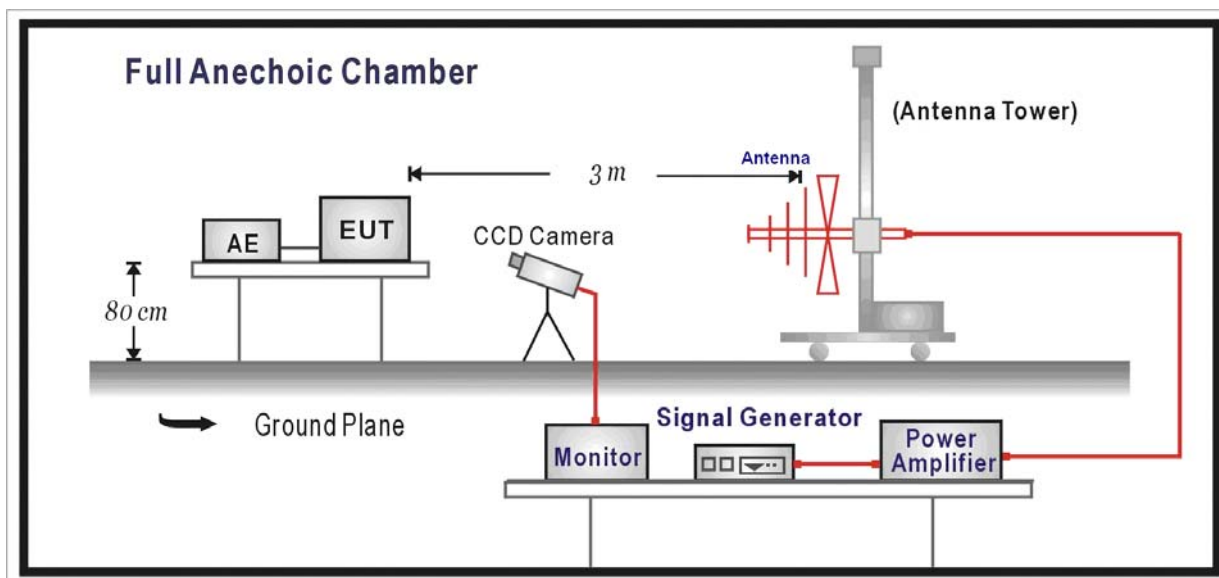

9.3. Limit

Item	Environmental Phenomena	Units	Test Specification	Performance Criteria
Enclosure Port				
	Radio-Frequency	MHz	80-1000	A
	Electromagnetic Field	V/m(Un-modulated, rms)	3	
	Amplitude Modulated	% AM (1kHz)	80	

9.4. Test Procedure

The EUT and load, which are placed on a table that is 0.8 meter above ground, are placed with one coincident with the calibration plane such that the distance from antenna to the EUT was 3 meters.

Both horizontal and vertical polarization of the antenna and four sides of the EUT are set on measurement.

In order to judge the EUT performance, a CCD camera is used to monitor EUT screen.

All the scanning conditions are as follows:

Condition of Test	Remarks
1. Field Strength	3 V/m Level 2
2. Radiated Signal	AM 80% Modulated with 1kHz
3. Scanning Frequency	80MHz - 1000MHz
4. Dwell Time	3 Seconds
5. Frequency step size Δf :	1%
6. The rate of Swept of Frequency	1.5×10^{-3} decades/s

9.5. Deviation from Test Standard

No deviation.

9.6. Test Result

Product	Vandal Dome Network Camera		
Test Item	Radiated susceptibility		
Test Mode	Mode 1: Normal Operation (Adapter: 3A-183WP12)		
Date of Test	2010/05/31	Test Site	Chamber5

Frequency (MHz)	Position (Angle)	Polarity (H or V)	Field Strength (V/m)	Required Criteria	Complied To Criteria (A, B, C)	Results
80-1000	FRONT	H	3	A	A	PASS
80-1000	FRONT	V	3	A	A	PASS
80-1000	BACK	H	3	A	A	PASS
80-1000	BACK	V	3	A	A	PASS
80-1000	RIGHT	H	3	A	A	PASS
80-1000	RIGHT	V	3	A	A	PASS
80-1000	LEFT	H	3	A	A	PASS
80-1000	LEFT	V	3	A	A	PASS
80-1000	UP	H	3	A	A	PASS
80-1000	UP	V	3	A	A	PASS
80-1000	DOWN	H	3	A	A	PASS
80-1000	DOWN	V	3	A	A	PASS

Note:

The testing performed is from lowest level up to the highest level as required by standard, but only highest level is shown on the report.

- Meet criteria A: Operate as intended during and after the test
- Meet criteria B: Operate as intended after the test
- Meet criteria C: Loss/Error of function
- Additional Information
 - There was no observable degradation in performance.
 - EUT stopped operation and could / could not be reset by operator at _____ V/m at frequency _____ MHz.
- No false alarms or other malfunctions were observed during or after the test.

Product	Vandal Dome Network Camera		
Test Item	Radiated susceptibility		
Test Mode	Mode 2: Normal Operation (AC 24V)		
Date of Test	2010/05/31	Test Site	Chamber5

Frequency (MHz)	Position (Angle)	Polarity (H or V)	Field Strength (V/m)	Required Criteria	Complied To Criteria (A, B, C)	Results
80-1000	FRONT	H	3	A	A	PASS
80-1000	FRONT	V	3	A	A	PASS
80-1000	BACK	H	3	A	A	PASS
80-1000	BACK	V	3	A	A	PASS
80-1000	RIGHT	H	3	A	A	PASS
80-1000	RIGHT	V	3	A	A	PASS
80-1000	LEFT	H	3	A	A	PASS
80-1000	LEFT	V	3	A	A	PASS
80-1000	UP	H	3	A	A	PASS
80-1000	UP	V	3	A	A	PASS
80-1000	DOWN	H	3	A	A	PASS
80-1000	DOWN	V	3	A	A	PASS

Note:

The testing performed is from lowest level up to the highest level as required by standard, but only highest level is shown on the report.

- Meet criteria A: Operate as intended during and after the test
- Meet criteria B: Operate as intended after the test
- Meet criteria C: Loss/Error of function
- Additional Information
 - There was no observable degradation in performance.
 - EUT stopped operation and could / could not be reset by operator at _____ V/m at frequency _____MHz.
- No false alarms or other malfunctions were observed during or after the test.

Product	Vandal Dome Network Camera		
Test Item	Radiated susceptibility		
Test Mode	Mode 3: PoE Mode		
Date of Test	2010/05/31	Test Site	Chamber5

Frequency (MHz)	Position (Angle)	Polarity (H or V)	Field Strength (V/m)	Required Criteria	Complied To Criteria (A, B, C)	Results
80-1000	FRONT	H	3	A	A	PASS
80-1000	FRONT	V	3	A	A	PASS
80-1000	BACK	H	3	A	A	PASS
80-1000	BACK	V	3	A	A	PASS
80-1000	RIGHT	H	3	A	A	PASS
80-1000	RIGHT	V	3	A	A	PASS
80-1000	LEFT	H	3	A	A	PASS
80-1000	LEFT	V	3	A	A	PASS
80-1000	UP	H	3	A	A	PASS
80-1000	UP	V	3	A	A	PASS
80-1000	DOWN	H	3	A	A	PASS
80-1000	DOWN	V	3	A	A	PASS

Note:

The testing performed is from lowest level up to the highest level as required by standard, but only highest level is shown on the report.

- Meet criteria A: Operate as intended during and after the test
- Meet criteria B: Operate as intended after the test
- Meet criteria C: Loss/Error of function
- Additional Information
 - There was no observable degradation in performance.
 - EUT stopped operation and could / could not be reset by operator at _____ V/m at frequency _____MHz.
- No false alarms or other malfunctions were observed during or after the test.

9.7. Test Photograph

Test Mode : Mode 1: Normal Operation (Adapter: 3A-183WP12)

Description : Radiated Susceptibility Test Setup



Test Mode : Mode 2: Normal Operation (AC 24V)

Description : Radiated Susceptibility Test Setup



Test Mode : Mode 3: PoE Mode

Description : Radiated Susceptibility Test Setup



10. Electrical Fast Transient/Burst

10.1. Test Specification

According to Standard : IEC 61000-4-4

10.2. Test Setup

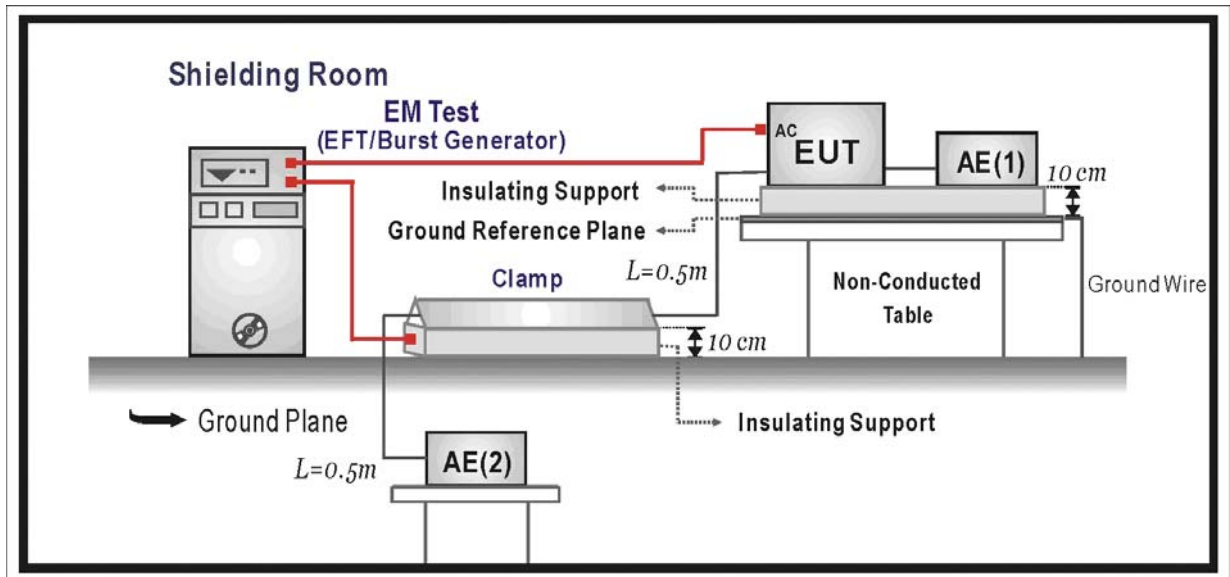

10.3. Limit

Item	Environmental Phenomena	Units	Test Specification	Performance Criteria
I/O and communication ports				
	Fast Transients Common Mode	kV (Peak) Tr/Th ns Rep. Frequency kHz	+0.5 5/50 5	B
Input DC Power Ports				
	Fast Transients Common Mode	kV (Peak) Tr/Th ns Rep. Frequency kHz	+0.5 5/50 5	B
Input AC Power Ports				
	Fast Transients Common Mode	kV (Peak) Tr/Th ns Rep. Frequency kHz	+1 5/50 5	B

10.4. Test Procedure

The EUT is placed on a table that is 0.8 meter height. A ground reference plane is placed on the table, and uses a 0.1m insulation between the EUT and ground reference plane.

The minimum area of the ground reference plane is 1m*1m, and 0.65mm thick min, and projected beyond the EUT by at least 0.1m on all sides.

Test on I/O and communication ports:

The EFT interference signal is through a coupling clamp device couples to the signal and control lines of the EUT with burst noise for 1 minute.

Test on power supply ports:

The EUT is connected to the power mains through a coupling device that directly couples the EFT/B interference signal.

Each of the Line and Neutral conductors is impressed with burst noise for 1 minute.

The length of the signal and power lines between the coupling device and the EUT is 0.5m.

10.5. Deviation from Test Standard

No deviation.

10.6. Test Result

Product	Vandal Dome Network Camera		
Test Item	Electrical fast transient/burst		
Test Mode	Mode 1: Normal Operation (Adapter: 3A-183WP12)		
Date of Test	2010/05/27	Test Site	No.2 Shielded Room

Inject Line	Polarity	Voltage kV	Inject Time (Second)	Inject Method	Required Criteria	Complied to Criteria	Result
L-N	±	1kV	60	Direct	B	B	PASS
LAN	±	0.5kV	60	Clamp	B	B	PASS
Coaxial	±	0.5kV	60	Clamp	B	B	PASS

Note:

The testing performed is from lowest level up to the highest level as required by standard, but only highest level is shown on the report.

- Meet criteria A : Operate as intended during and after the test
- Meet criteria B : Operate as intended after the test
- Meet criteria C : Loss/Error of function
- Additional Information
 - EUT stopped operation and could / could not be reset by operator at _____ kV of Line _____.
- No false alarms or other malfunctions were observed during or after the test.

Product	Vandal Dome Network Camera		
Test Item	Electrical fast transient/burst		
Test Mode	Mode 2: Normal Operation (AC 24V)		
Date of Test	2010/05/27	Test Site	No.2 Shielded Room

Inject Line	Polarity	Voltage kV	Inject Time (Second)	Inject Method	Required Criteria	Complied to Criteria	Result
L-N	±	1kV	60	Direct	B	B	PASS
LAN	±	0.5kV	60	Clamp	B	B	PASS
Coaxial	±	0.5kV	60	Clamp	B	B	PASS

Note:

The testing performed is from lowest level up to the highest level as required by standard, but only highest level is shown on the report.

- Meet criteria A : Operate as intended during and after the test
- Meet criteria B : Operate as intended after the test
- Meet criteria C : Loss/Error of function
- Additional Information
 - EUT stopped operation and could / could not be reset by operator at _____ kV of Line _____.
- No false alarms or other malfunctions were observed during or after the test.

Product	Vandal Dome Network Camera		
Test Item	Electrical fast transient/burst		
Test Mode	Mode 3: PoE Mode		
Date of Test	2010/05/27	Test Site	No.2 Shielded Room

Inject Line	Polarity	Voltage kV	Inject Time (Second)	Inject Method	Required Criteria	Complied to Criteria	Result
LAN	±	0.5kV	60	Clamp	B	B	PASS
Coaxial	±	0.5kV	60	Clamp	B	B	PASS

Note:

The testing performed is from lowest level up to the highest level as required by standard, but only highest level is shown on the report.

- Meet criteria A : Operate as intended during and after the test
- Meet criteria B : Operate as intended after the test
- Meet criteria C : Loss/Error of function
- Additional Information
 - EUT stopped operation and could / could not be reset by operator at _____ kV of Line _____.
 - No false alarms or other malfunctions were observed during or after the test.

10.7. Test Photograph

Test Mode : Mode 1: Normal Operation (Adapter: 3A-183WP12)

Description : EFT/B Test Setup



Test Mode : Mode 1: Normal Operation (Adapter: 3A-183WP12)

Description : EFT/B Test Setup-Clamp



Test Mode : Mode 2: Normal Operation (AC 24V)

Description : EFT/B Test Setup



Test Mode : Mode 2: Normal Operation (AC 24V)

Description : EFT/B Test Setup-Clamp



Test Mode : Mode 3:PoE Mode

Description : EFT/B Test Setup-Clamp



11. Surge

11.1. Test Specification

According to Standard : IEC 61000-4-5

11.2. Test Setup

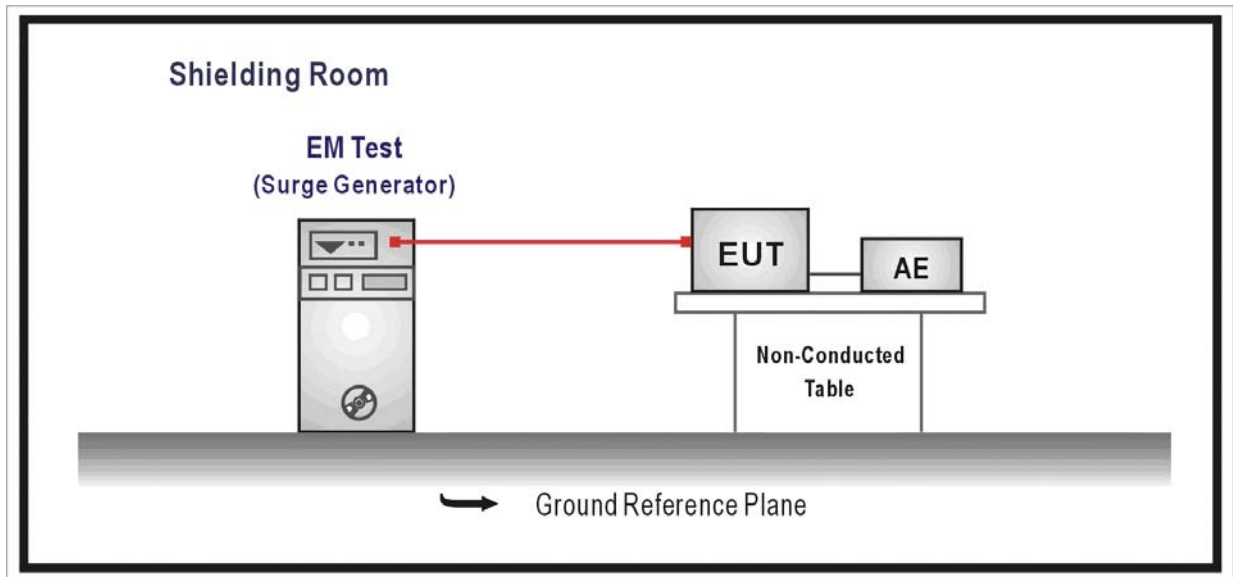

11.3. Limit

Item	Environmental Phenomena	Units	Test Specification	Performance Criteria
Signal Ports and Telecommunication Ports(See 1) and 2))				
	Surges Line to Ground	Tr/Th us kV	1.2/50 (8/20) ± 1	B
Input DC Power Ports				
	Surges Line to Ground	Tr/Th us kV	1.2/50 (8/20) ± 0.5	B
AC Input and AC Output Power Ports				
	Surges Line to Line Line to Ground	Tr/Th us kV kV	1.2/50 (8/20) ± 1 ± 2	B

Notes:

- 1) Applicable only to ports which according to the manufacturer’s may directly to outdoor cables.
- 2) Where normal functioning cannot be achieved because of the impact of the CDN on the EUT, no immunity test shall be required.

11.4. Test Procedure

The EUT and its load are placed on a table that is 0.8 meter above a metal ground plane measured 1m*1m min. and 0.65mm thick min. And projected beyond the EUT by at least 0.1m on all sides. The length of power cord between the coupling device and the EUT shall be 2m or less.

For Input and Output AC Power or DC Input and DC Output Power Ports:

The EUT is connected to the power mains through a coupling device that directly couples the Surge interference signal.

The surge noise shall be applied synchronized to the voltage phase at 0⁰, 90⁰, 180⁰, 270⁰ and the peak value of the a.c. voltage wave. (Positive and negative)

Each of Line-Earth and Line-Line is impressed with a sequence of five surge voltages with interval of 1 min.

11.5. Deviation from Test Standard

No deviation.

11.6. Test Result

Product	Vandal Dome Network Camera		
Test Item	Surge		
Test Mode	Mode 1: Normal Operation (Adapter: 3A-183WP12)		
Date of Test	2010/05/27	Test Site	No.2 Shielded Room

Inject Line	Polarity	Angle	Voltage kV	Time Interval (Second)	Inject Method	Required Criteria	Complied to Criteria	Result
L-N	±	0	1kV	60	Direct	B	B	PASS
L-N	±	90	1kV	60	Direct	B	B	PASS
L-N	±	180	1kV	60	Direct	B	B	PASS
L-N	±	270	1kV	60	Direct	B	B	PASS

Note:

The testing performed is from lowest level up to the highest level as required by standard, but only highest level is shown on the report.

- Meet criteria A : Operate as intended during and after the test
- Meet criteria B : Operate as intended after the test
- Meet criteria C : Loss/Error of function
- Additional Information
 - EUT stopped operation and could / could not be reset by operator at _____ kV of Line _____.
- No false alarms or other malfunctions were observed during or after the test.

Product	Vandal Dome Network Camera		
Test Item	Surge		
Test Mode	Mode 2: Normal Operation (AC 24V)		
Date of Test	2010/05/27	Test Site	No.2 Shielded Room

Inject Line	Polarity	Angle	Voltage kV	Time Interval (Second)	Inject Method	Required Criteria	Complied to Criteria	Result
L-N	±	0	1kV	60	Direct	B	B	PASS
L-N	±	90	1kV	60	Direct	B	B	PASS
L-N	±	180	1kV	60	Direct	B	B	PASS
L-N	±	270	1kV	60	Direct	B	B	PASS

Note:

The testing performed is from lowest level up to the highest level as required by standard, but only highest level is shown on the report.

- Meet criteria A : Operate as intended during and after the test
- Meet criteria B : Operate as intended after the test
- Meet criteria C : Loss/Error of function
- Additional Information
 - EUT stopped operation and could / could not be reset by operator at _____ kV of Line _____.
- No false alarms or other malfunctions were observed during or after the test.

11.7. Test Photograph

Test Mode : Mode 1: Normal Operation (Adapter: 3A-183WP12)

Description : SURGE Test Setup



Test Mode : Mode 2: Normal Operation (AC 24V)

Description : SURGE Test Setup



12. Conducted Susceptibility

12.1. Test Specification

According to Standard : IEC 61000-4-6

12.2. Test Setup

CDN Test Mode

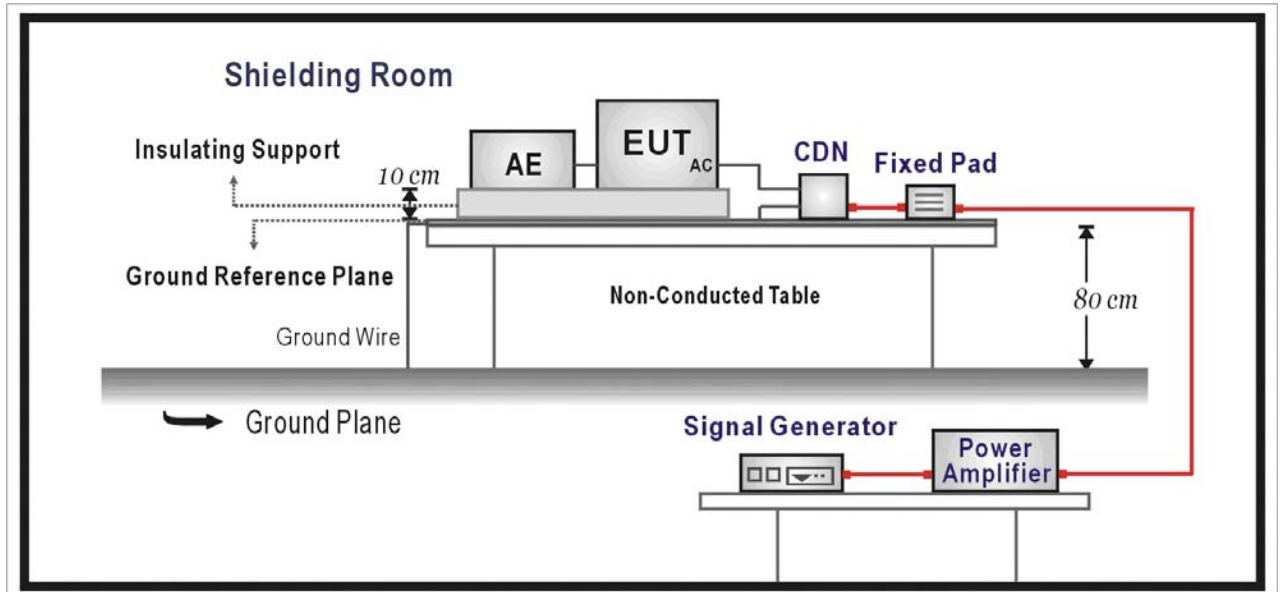

EM Clamp Test Mode

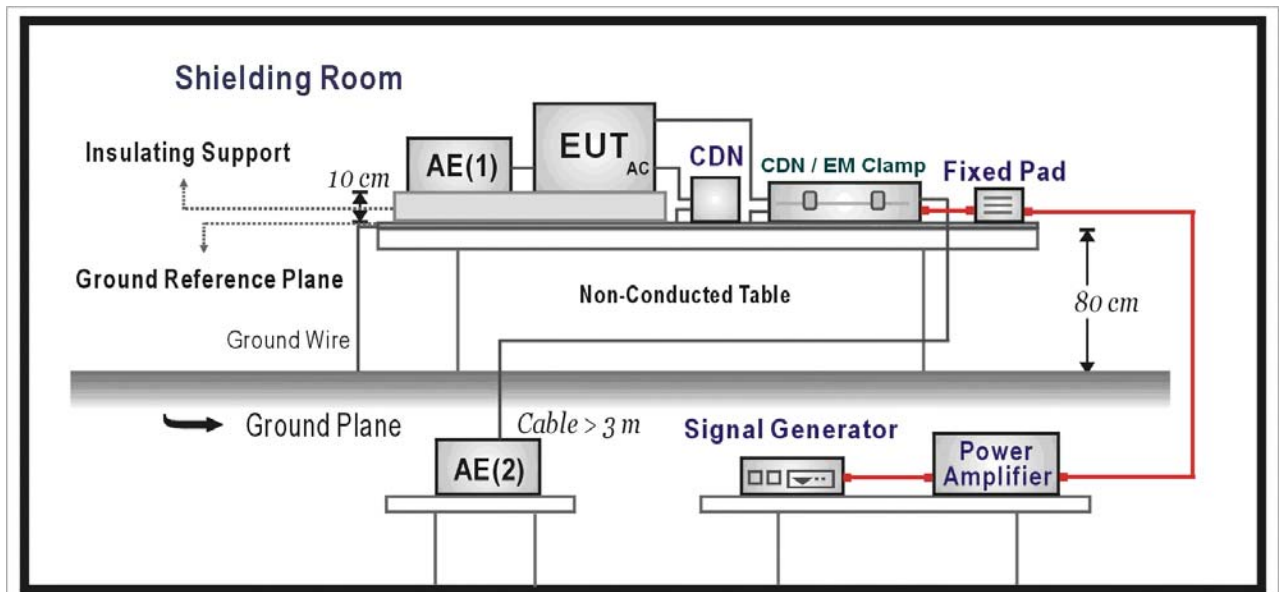

12.3. Limit

Item	Environmental Phenomena	Units	Test Specification	Performance Criteria
Signal Ports and Telecommunication Ports				
	Radio-Frequency Continuous Conducted	MHz V (rms, Un-modulated) % AM (1kHz)	0.15-80 3 80	A
Input DC Power Ports				
	Radio-Frequency Continuous Conducted	MHz V (rms, Un-modulated) % AM (1kHz)	0.15-80 3 80	A
Input AC Power Ports				
	Radio-Frequency Continuous Conducted	MHz V (rms, Un-modulated) % AM (1kHz)	0.15-80 3 80	A

12.4. Test Procedure

The EUT are placed on a table that is 0.8 meter height, and a Ground reference plane on the table, EUT are placed upon table and use a 10cm insulation between the EUT and Ground reference plane.

For Signal Ports and Telecommunication Ports

The disturbance signal is through a coupling and decoupling networks (CDN) or EM-clamp device couples to the signal and Telecommunication lines of the EUT.

For Input DC and AC Power Ports

The EUT is connected to the power mains through a coupling and decoupling networks for power supply lines. And directly couples the disturbances signal into EUT.

Used CDN-M2 for two wires or CDN-M3 for three wires.

All the scanning conditions are as follows:

Condition of Test	Remarks
1. Field Strength	130dBuV(3V) Level 2
2. Radiated Signal	AM 80% Modulated with 1kHz
3. Scanning Frequency	0.15MHz – 80MHz
4. Dwell Time	3 Seconds
5. Frequency step size Δf :	1%
6. The rate of Swept of Frequency	1.5×10^{-3} decades/s

12.5. Deviation from Test Standard

No deviation.

12.6. Test Result

Product	Vandal Dome Network Camera		
Test Item	Conducted susceptibility		
Test Mode	Mode 1: Normal Operation (Adapter: 3A-183WP12)		
Date of Test	2010/05/28	Test Site	No.6 Shielded Room

Frequency Range (MHz)	Voltage Applied dBuV(V)	Inject Method	Tested Port of EUT	Required Criteria	Performance Criteria Complied To	Result
0.15~80	130 (3V)	CDN	AC IN	A	A	PASS
0.15~80	130 (3V)	CDN	LAN	A	A	PASS
0.15~80	130 (3V)	Clamp	Coaxial	A	A	PASS

Note:

The testing performed is from lowest level up to the highest level as required by standard, but only highest level is shown on the report.

- Meet criteria A : Operate as intended during and after the test
- Meet criteria B : Operate as intended after the test
- Meet criteria C : Loss/Error of function
- Additional Information
 - EUT stopped operation and could / could not be reset by operator at _____ dBuV(V) at frequency _____MHz.
 - No false alarms or other malfunctions were observed during or after the test. The acceptance criteria were met, and the EUT passed the test.

Product	Vandal Dome Network Camera		
Test Item	Conducted susceptibility		
Test Mode	Mode 2: Normal Operation (AC 24V)		
Date of Test	2010/05/28	Test Site	No.6 Shielded Room

Frequency Range (MHz)	Voltage Applied dBuV(V)	Inject Method	Tested Port of EUT	Required Criteria	Performance Criteria Complied To	Result
0.15~80	130 (3V)	CDN	AC IN	A	A	PASS
0.15~80	130 (3V)	CDN	LAN	A	A	PASS
0.15~80	130 (3V)	Clamp	Coaxial	A	A	PASS

Note:

The testing performed is from lowest level up to the highest level as required by standard, but only highest level is shown on the report.

- Meet criteria A : Operate as intended during and after the test
- Meet criteria B : Operate as intended after the test
- Meet criteria C : Loss/Error of function
- Additional Information
 - EUT stopped operation and could / could not be reset by operator at _____ dBuV(V) at frequency _____MHz.
 - No false alarms or other malfunctions were observed during or after the test. The acceptance criteria were met, and the EUT passed the test.

Product	Vandal Dome Network Camera		
Test Item	Conducted susceptibility		
Test Mode	Mode 3: PoE Mode		
Date of Test	2010/05/28	Test Site	No.6 Shielded Room

Frequency Range (MHz)	Voltage Applied dBuV(V)	Inject Method	Tested Port of EUT	Required Criteria	Performance Criteria Complied To	Result
0.15~80	130 (3V)	CDN	LAN	A	A	PASS
0.15~80	130 (3V)	Clamp	Coaxial	A	A	PASS

Note:

The testing performed is from lowest level up to the highest level as required by standard, but only highest level is shown on the report.

- Meet criteria A : Operate as intended during and after the test
- Meet criteria B : Operate as intended after the test
- Meet criteria C : Loss/Error of function
- Additional Information
 - EUT stopped operation and could / could not be reset by operator at _____ dBuV(V) at frequency _____MHz.
 - No false alarms or other malfunctions were observed during or after the test. The acceptance criteria were met, and the EUT passed the test.

12.7. Test Photograph

Test Mode : Mode 1: Normal Operation (Adapter: 3A-183WP12)

Description : Conducted Susceptibility Test Setup



Test Mode : Mode 1: Normal Operation (Adapter: 3A-183WP12)

Description : Conducted Susceptibility Test Setup-CDN



Test Mode : Mode 2: Normal Operation (AC 24V)

Description : Conducted Susceptibility Test Setup



Test Mode : Mode 2: Normal Operation (AC 24V)

Description : Conducted Susceptibility Test Setup-CDN



Test Mode : Mode 3: PoE Mode

Description : Conducted Susceptibility Test Setup-CDN



13. Power Frequency Magnetic Field

13.1. Test Specification

According to Standard : IEC 61000-4-8

13.2. Test Setup

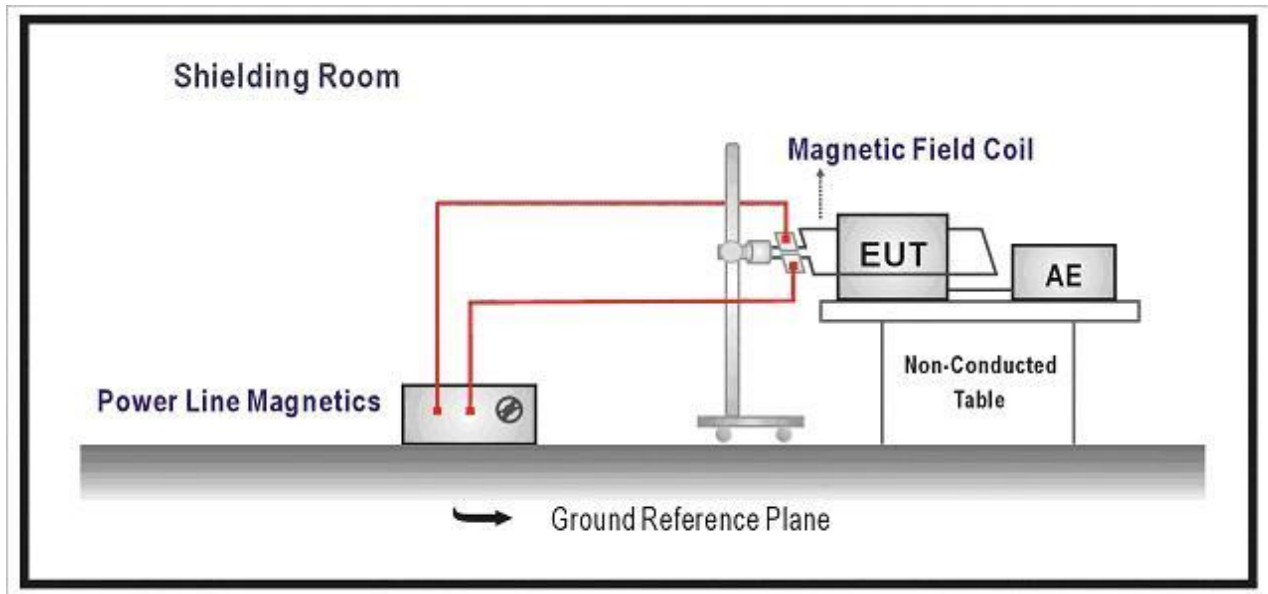

13.3. Limit

Item	Environmental Phenomena	Units	Test Specification	Performance Criteria
Enclosure Port				
	Power-Frequency Magnetic Field	Hz A/m (r.m.s.)	50 1	A

13.4. Test Procedure

The EUT and its load are placed on a table which is 0.8 meter above a metal ground plane measured at least 1m*1m min. The test magnetic field shall be placed at central of the induction coil.

The test magnetic Field shall be applied 10 minutes by the immersion method to the EUT. And the induction coil shall be rotated by 90° in order to expose the EUT to the test field with different orientation (X, Y, Z Orientations).

13.5. Deviation from Test Standard

No deviation.

13.6. Test Result

Product	Vandal Dome Network Camera		
Test Item	Power frequency magnetic field		
Test Mode	Mode 1: Normal Operation (Adapter: 3A-183WP12)		
Date of Test	2010/05/26	Test Site	No.3 Shielded Room

Polarization	Frequency (Hz)	Magnetic Strength (A/m)	Required Performance Criteria	Performance Criteria Complied To	Test Result
X Orientation	50	1	A	A	PASS
Y Orientation	50	1	A	A	PASS
Z Orientation	50	1	A	A	PASS

- Meet criteria A: Operate as intended during and after the test
- Meet criteria B: Operate as intended after the test
- Meet criteria C: Loss/Error of function
- Additional Information
 - EUT stopped operation and could / could not be reset by operator at _____ kV of Line _____.
- No false alarms or other malfunctions were observed during or after the test. The acceptance criteria were met, and the EUT passed the test.

Product	Vandal Dome Network Camera		
Test Item	Power frequency magnetic field		
Test Mode	Mode 2: Normal Operation (AC 24V)		
Date of Test	2010/05/26	Test Site	No.3 Shielded Room

Polarization	Frequency (Hz)	Magnetic Strength (A/m)	Required Performance Criteria	Performance Criteria Complied To	Test Result
X Orientation	50	1	A	A	PASS
Y Orientation	50	1	A	A	PASS
Z Orientation	50	1	A	A	PASS

- Meet criteria A: Operate as intended during and after the test
- Meet criteria B: Operate as intended after the test
- Meet criteria C: Loss/Error of function
- Additional Information
 - EUT stopped operation and could / could not be reset by operator at _____ kV of Line _____.
- No false alarms or other malfunctions were observed during or after the test. The acceptance criteria were met, and the EUT passed the test.

Product	Vandal Dome Network Camera		
Test Item	Power frequency magnetic field		
Test Mode	Mode 3: PoE Mode		
Date of Test	2010/05/26	Test Site	No.3 Shielded Room

Polarization	Frequency (Hz)	Magnetic Strength (A/m)	Required Performance Criteria	Performance Criteria Complied To	Test Result
X Orientation	50	1	A	A	PASS
Y Orientation	50	1	A	A	PASS
Z Orientation	50	1	A	A	PASS

- Meet criteria A: Operate as intended during and after the test
- Meet criteria B: Operate as intended after the test
- Meet criteria C: Loss/Error of function
- Additional Information
 - EUT stopped operation and could / could not be reset by operator at _____ kV of Line _____.
- No false alarms or other malfunctions were observed during or after the test. The acceptance criteria were met, and the EUT passed the test.

13.7. Test Photograph

Test Mode : Mode 1: Normal Operation (Adapter: 3A-183WP12)

Description : Power Frequency Magnetic Field Test Setup

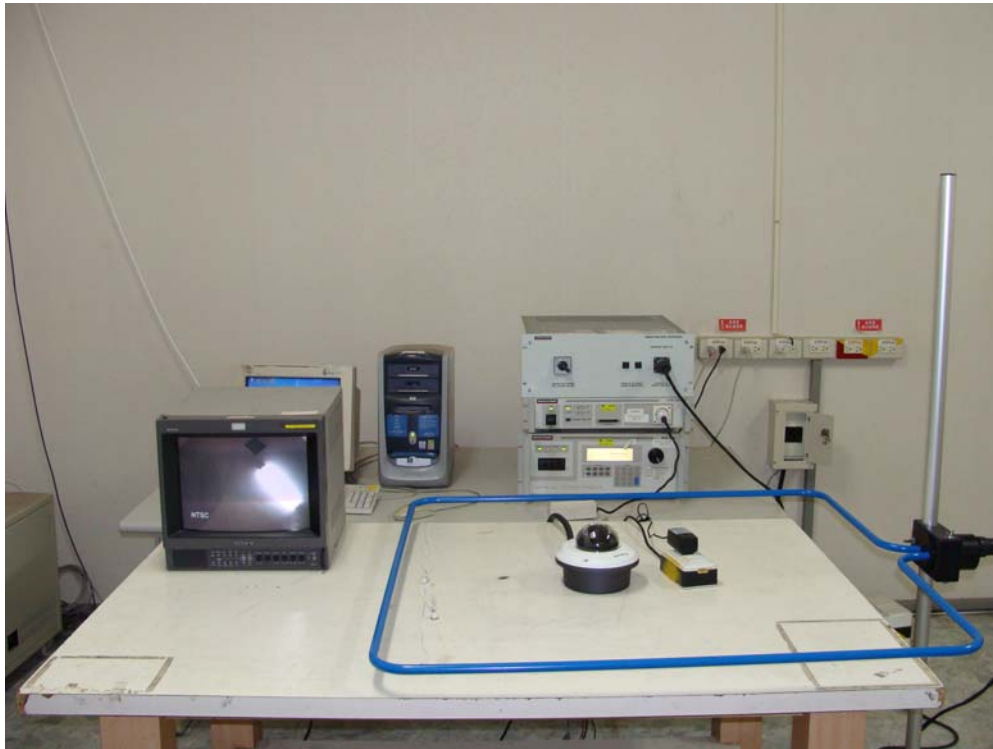

Test Mode : Mode 2: Normal Operation (AC 24V)

Description : Power Frequency Magnetic Field Test Setup



Test Mode : Mode 3: PoE Mode

Description : Power Frequency Magnetic Field Test Setup



14. Voltage Dips and Interruption

14.1. Test Specification

According to Standard : IEC 61000-4-11

14.2. Test Setup

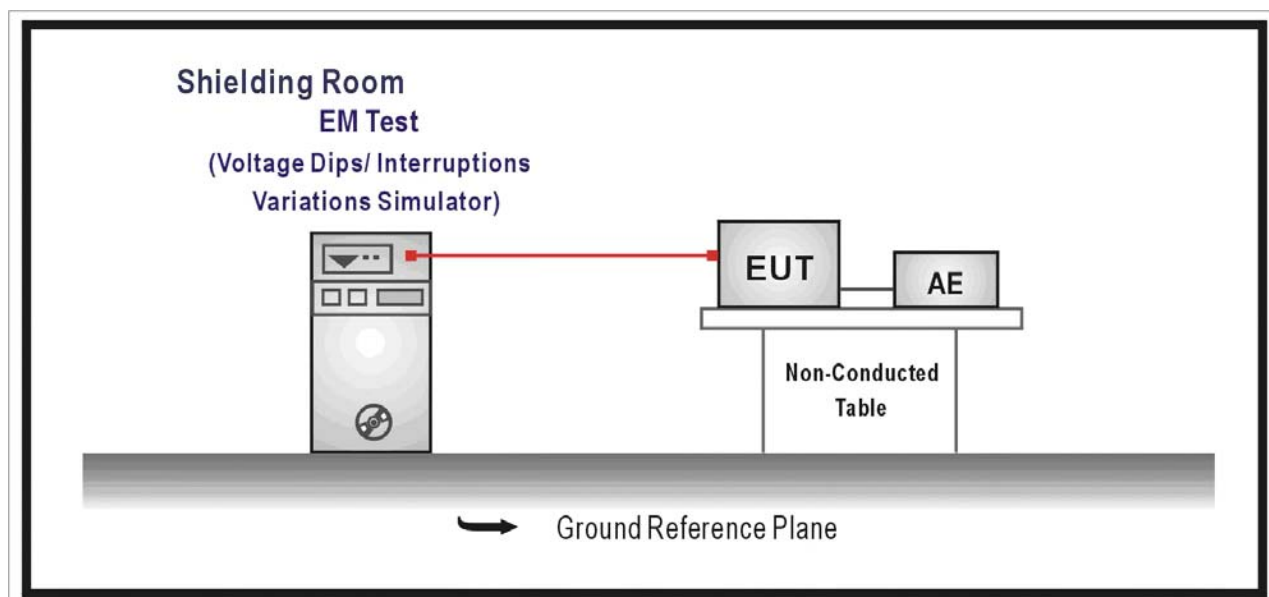

14.3. Limit

Item	Environmental Phenomena	Units	Test Specification	Performance Criteria
Input AC Power Ports				
	Voltage Dips	% Reduction	30	C
		Period	25	
	Voltage Interruptions	% Reduction	>95	B
		Period	0.5	
	Voltage Interruptions	% Reduction	> 95	C
		Period	250	

14.4. Test Procedure

The EUT and its load are placed on a table which is 0.8 meter above a metal ground plane measured 1m*1m min. And 0.65mm thick min. And projected beyond the EUT by at least 0.1m on all sides. The power cord shall be used the shortest power cord as specified by the manufacturer.

For Voltage Dips/ Interruptions test:

The selection of test voltage is based on the rated power range. If the operation range is large than 20% of lower power range, both end of specified voltage shall be tested.

Otherwise, the typical voltage specification is selected as test voltage.

The EUT is connected to the power mains through a coupling device that directly couples to the Voltage Dips and Interruption Generator.

The EUT shall be tested for 30% voltage dip of supplied voltage and duration 25 Periods, for 95% voltage dip of supplied voltage and duration 0.5 Periods with a sequence of three voltage dips with intervals of 10 seconds, and for 95% voltage interruption of supplied voltage and duration 250 Periods with a sequence of three voltage interruptions with intervals of 10 seconds.

Voltage phase shifting are shall occur at 0° , 45° , 90° , 135° , 180° , 225° , 270° , 315° of the voltage.

14.5. Deviation from Test Standard

No deviation.

14.6. Test Result

Product	Vandal Dome Network Camera		
Test Item	Voltage dips and interruption		
Test Mode	Mode 1: Normal Operation (Adapter: 3A-183WP12)		
Date of Test	2010/05/27	Test Site	No.2 Shielded Room

Voltage Dips and Interruption Reduction(%)	Angle	Test Duration (Periods)	Required Performance Criteria	Performance Criteria Complied To	Test Result
30	0	25	C	A	PASS
30	45	25	C	A	PASS
30	90	25	C	A	PASS
30	135	25	C	A	PASS
30	180	25	C	A	PASS
30	225	25	C	A	PASS
30	270	25	C	A	PASS
30	315	25	C	A	PASS
>95	0	0.5	B	A	PASS
>95	45	0.5	B	A	PASS
>95	90	0.5	B	A	PASS
>95	135	0.5	B	A	PASS
>95	180	0.5	B	A	PASS
>95	225	0.5	B	A	PASS
>95	270	0.5	B	A	PASS
>95	315	0.5	B	A	PASS
>95	0	250	C	B	PASS
>95	45	250	C	B	PASS
>95	90	250	C	B	PASS
>95	135	250	C	B	PASS
>95	180	250	C	B	PASS
>95	225	250	C	B	PASS
>95	270	250	C	B	PASS
>95	315	250	C	B	PASS

- Meet criteria A: Operate as intended during and after the test
- Meet criteria B: Operate as intended after the test
- Meet criteria C: Loss/Error of function
- Additional Information
 - The nominal voltage of EUT is 230V.
 - EUT stopped operation and could / could not be reset by operator at _____ kV of Line _____.
- No false alarms or other malfunctions were observed during or after the test. The acceptance criteria were met, and the EUT passed the test.

Product	Vandal Dome Network Camera		
Test Item	Voltage dips and interruption		
Test Mode	Mode 2: Normal Operation (AC 24V)		
Date of Test	2010/05/27	Test Site	No.2 Shielded Room

Voltage Dips and Interruption Reduction(%)	Angle	Test Duration (Periods)	Required Performance Criteria	Performance Criteria Complied To	Test Result
30	0	25	C	A	PASS
30	45	25	C	A	PASS
30	90	25	C	A	PASS
30	135	25	C	A	PASS
30	180	25	C	A	PASS
30	225	25	C	A	PASS
30	270	25	C	A	PASS
30	315	25	C	A	PASS
>95	0	0.5	B	A	PASS
>95	45	0.5	B	A	PASS
>95	90	0.5	B	A	PASS
>95	135	0.5	B	A	PASS
>95	180	0.5	B	A	PASS
>95	225	0.5	B	A	PASS
>95	270	0.5	B	A	PASS
>95	315	0.5	B	A	PASS
>95	0	250	C	B	PASS
>95	45	250	C	B	PASS
>95	90	250	C	B	PASS
>95	135	250	C	B	PASS
>95	180	250	C	B	PASS
>95	225	250	C	B	PASS
>95	270	250	C	B	PASS
>95	315	250	C	B	PASS

- Meet criteria A: Operate as intended during and after the test
- Meet criteria B: Operate as intended after the test
- Meet criteria C: Loss/Error of function
- Additional Information
 - The nominal voltage of EUT is 230V.
 - EUT stopped operation and could / could not be reset by operator at _____ kV of Line _____.
- No false alarms or other malfunctions were observed during or after the test. The acceptance criteria were met, and the EUT passed the test.

14.7. Test Photograph

Test Mode : Mode 1: Normal Operation (Adapter: 3A-183WP12)

Description : Voltage Dips Test Setup



Test Mode : Mode 2: Normal Operation (AC 24V)

Description : Voltage Dips Test Setup



15. Attachment

➤ EUT Photograph

(1) EUT Photo



(2) EUT Photo



(3) EUT Photo



(4) EUT Photo



(5) EUT Photo



(6) EUT Photo



(7) EUT Photo



(8) EUT Photo



(9) EUT Photo



(10) EUT Photo



(11) EUT Photo



(12) EUT Photo

